



Scout Dress

Sizes 18-34
with cup sizes A-H

5/8 inch (in) (1.5 cm) seam allowances are included on all pattern pieces.

SIZE 18-34 PATTERN SIZE KEY

18	-----
20
22
24	-----
26
28	-----
30
32	-----
34	-----

SYMBOL KEY

grainline arrow



match point/
placement mark



© 2023 Charm Patterns
by Gertie. Distribution
and Commercial Use
Prohibited.

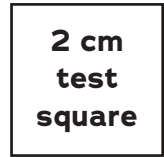

PAGE

1

FOLD BACK THIS MARGIN

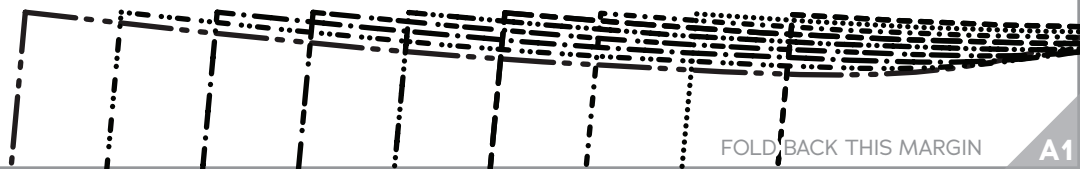

FOLD BACK THIS MARGIN

A1

PAGE

2

FOLD BACK THIS MARGIN

A1

FOLD BACK THIS MARGIN

A2

PAGE

3

COLLAR
MATCH
POINT

FOLD BACK THIS MARGIN



Scout Dress

SIZES 18-34

CENTER FRONT

FOLD BACK THIS MARGIN

A2

A3

PAGE

4

Bodice Back Neck Facing

Cut 1 fabric on fold,
1 interfacing on fold



Scout Dress

SIZES 18-34

FOLD

FOLD BACK THIS MARGIN

FOLD BACK THIS MARGIN

A3

A4

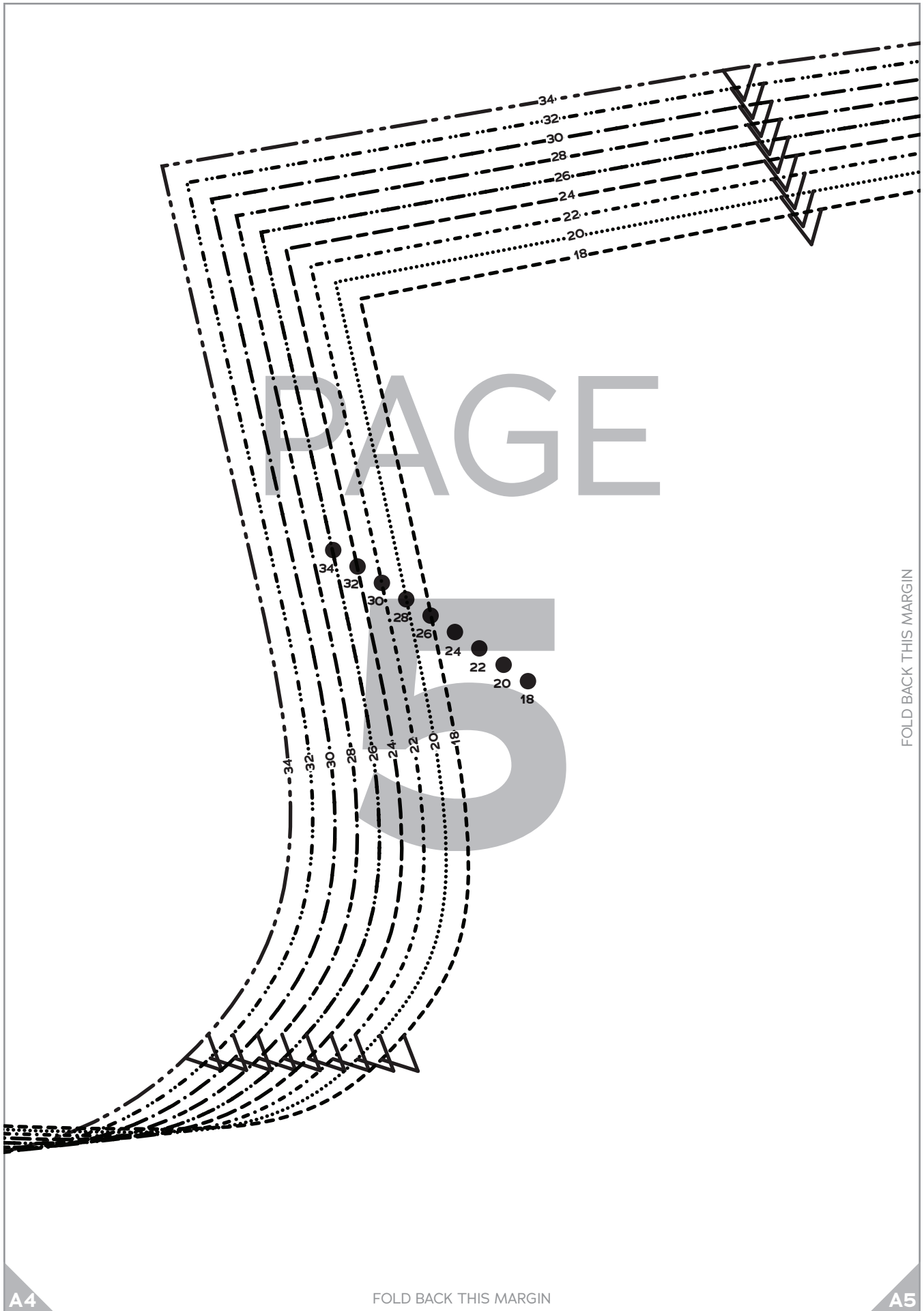

PAGE

5

FOLD BACK THIS MARGIN

FOLD BACK THIS MARGIN

A4

A5

PAGE

6

●
COLLAR
MATCH
POINT

FOLD BACK THIS MARGIN



GRA



Scout Dress

SIZES 18-34

FOLD BACK THIS MARGIN

CENTER FRONT

A5

A6

PAGE

7

FOLD BACK THIS MARGIN

A6

FOLD BACK THIS MARGIN

A7

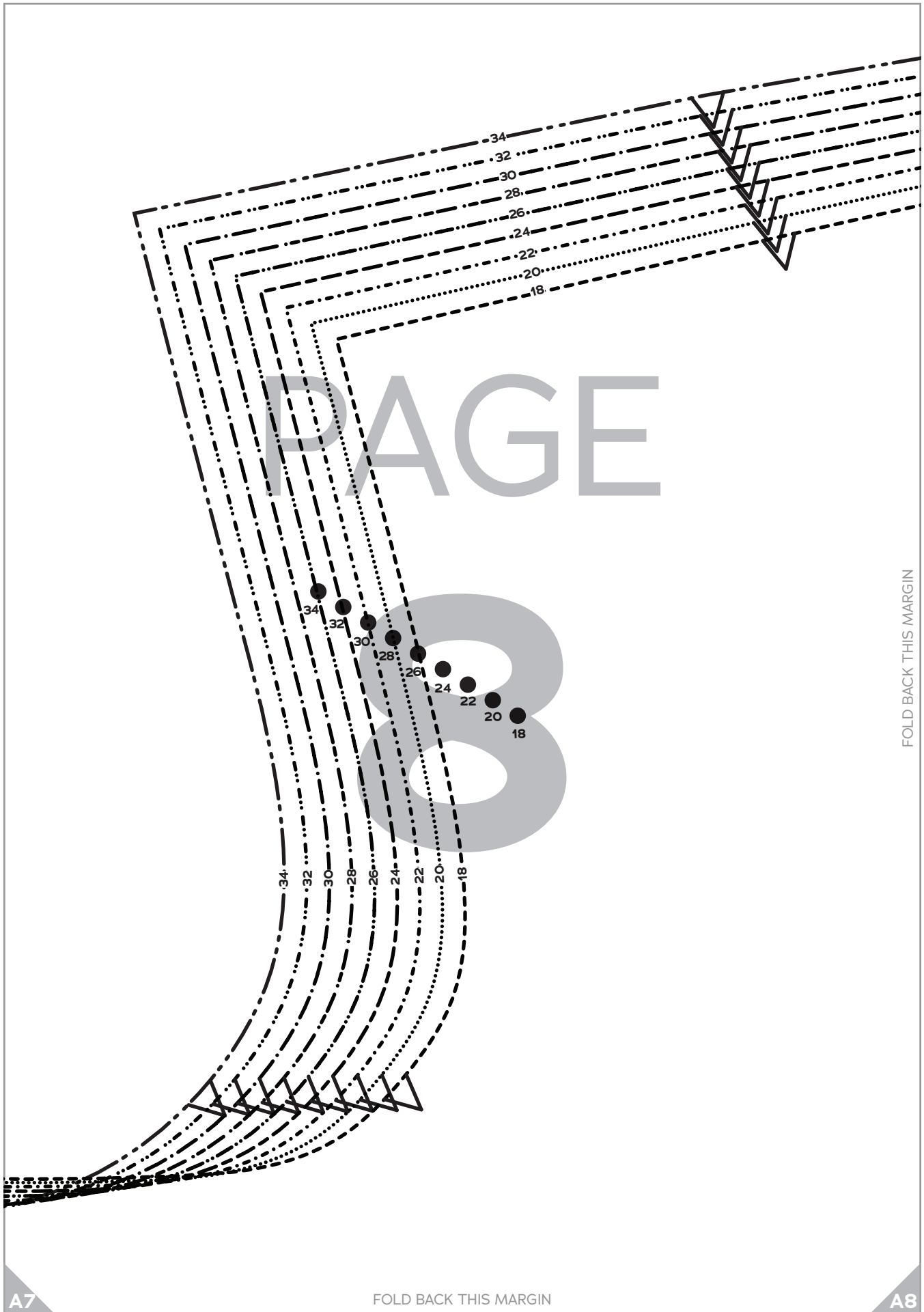

PAGE

8

FOLD BACK THIS MARGIN

A7

FOLD BACK THIS MARGIN

A8

PAGE

●
COLLAR
MATCH
POINT

FOLD BACK THIS MARGIN

CENTER FRONT



Scout Dress

SIZES 18-34

FOLD BACK THIS MARGIN

GRAINL

A8

A9

PAGE 10

18
20
22
24
26
28
30
32
34

18
20
22
24
26
28
30
32
34

SHORTEN/LENGTHEN LINE

18
20
22
24

FOLD BACK THIS MARGIN



TURNOUT
POINT

FOLD BACK THIS MARGIN

A6

A10

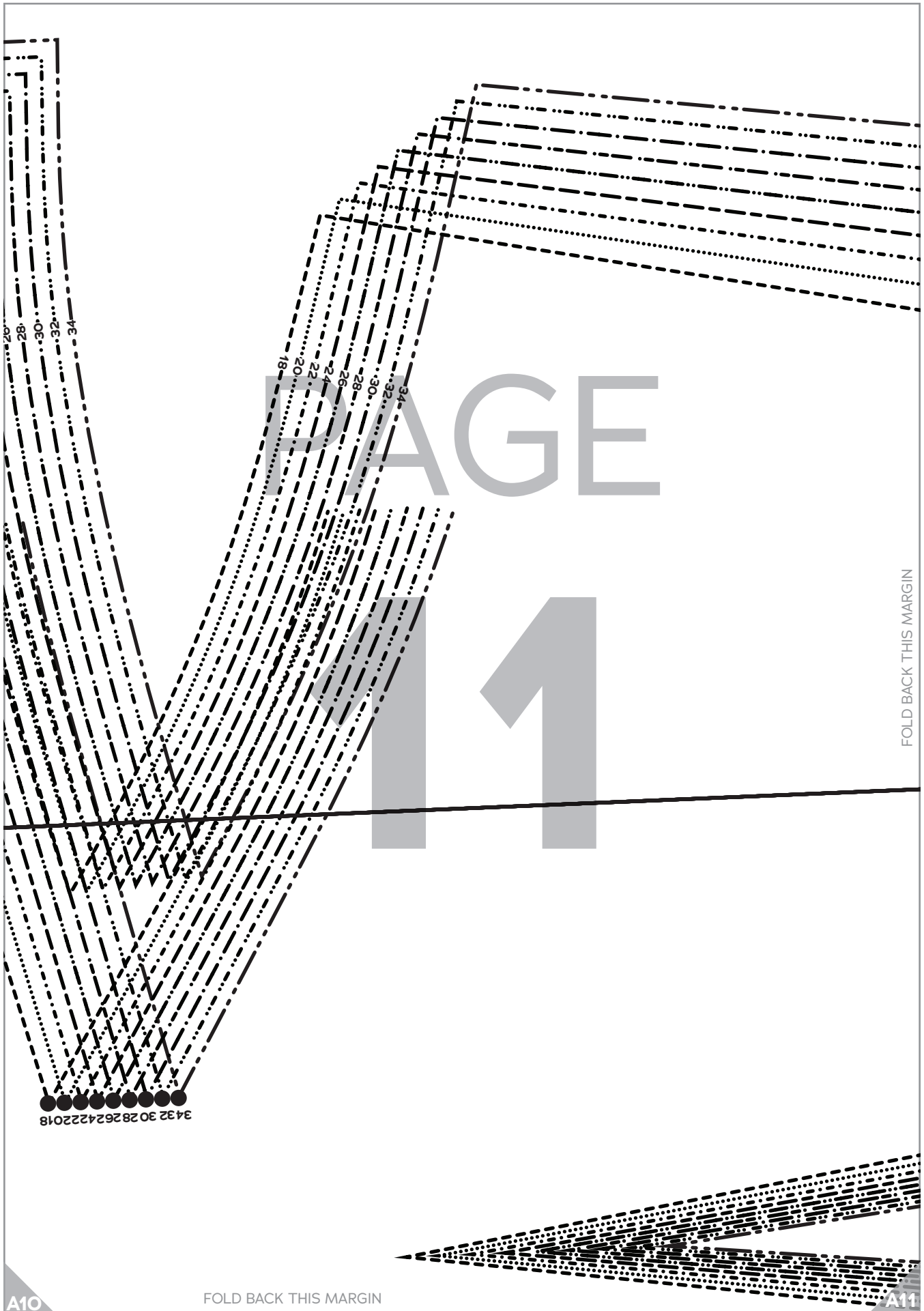

A10

FOLD BACK THIS MARGIN

A11

PAGE
12

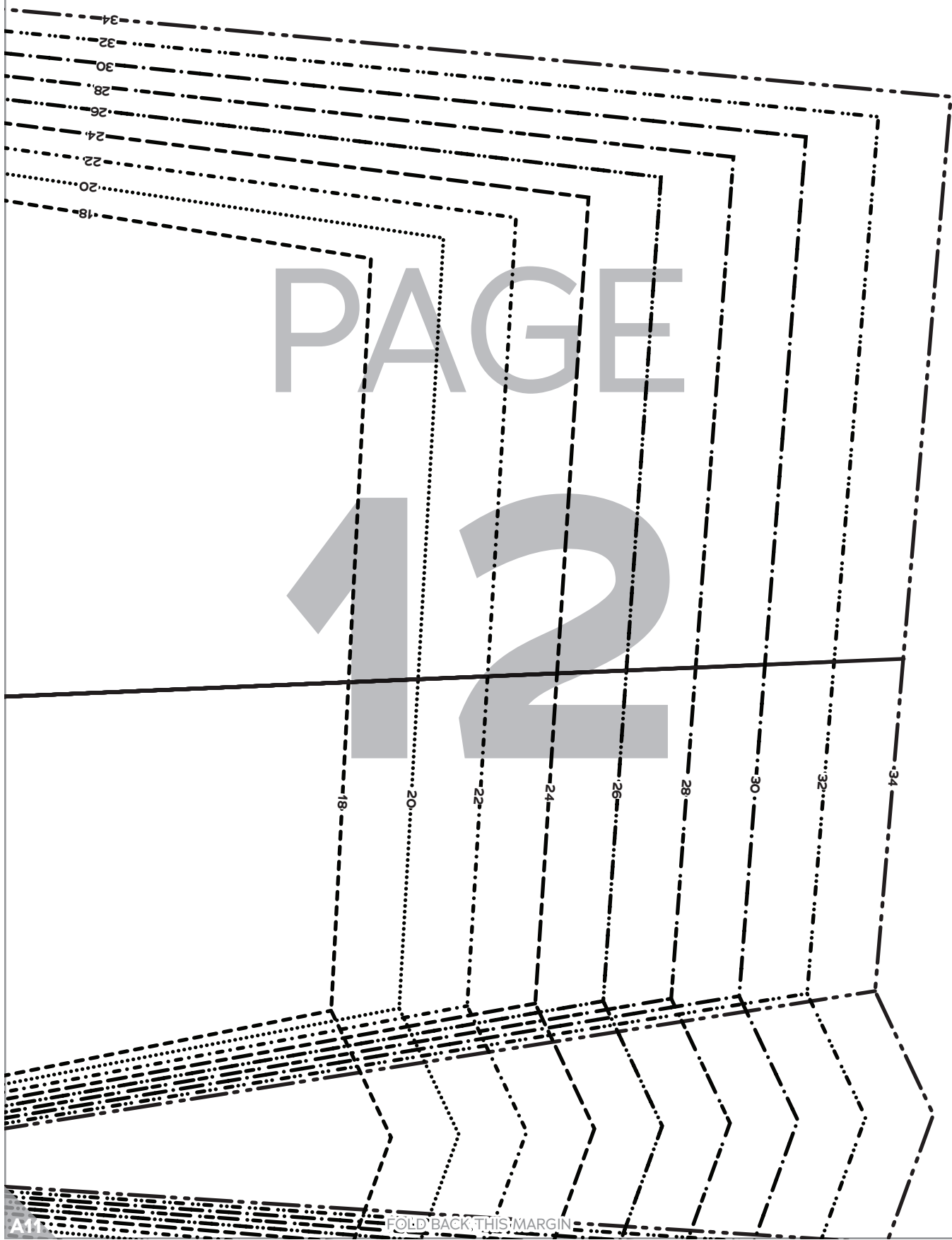

PAGE

13

FOLD BACK THIS MARGIN

FOLD BACK THIS MARGIN

A1

A2

PAGE

14

34 32 30 28 26 24 22 20 18

FOLD BACK THIS MARGIN

B1

FOLD BACK THIS MARGIN

B2

A2

A3

GRAINLINE

1
Bodice
Front,
A/B Cup
Cut 2 fabric

NT

PAGE

LAPEL
TURNOUT
POINT

15

SHORTEN/LENGTHEN LINE

FOLD BACK THIS MARGIN

18
22
26
30
32

34

18
20
22
24
26

B2

FOLD BACK THIS MARGIN

B3

A3

A4

B3

B4

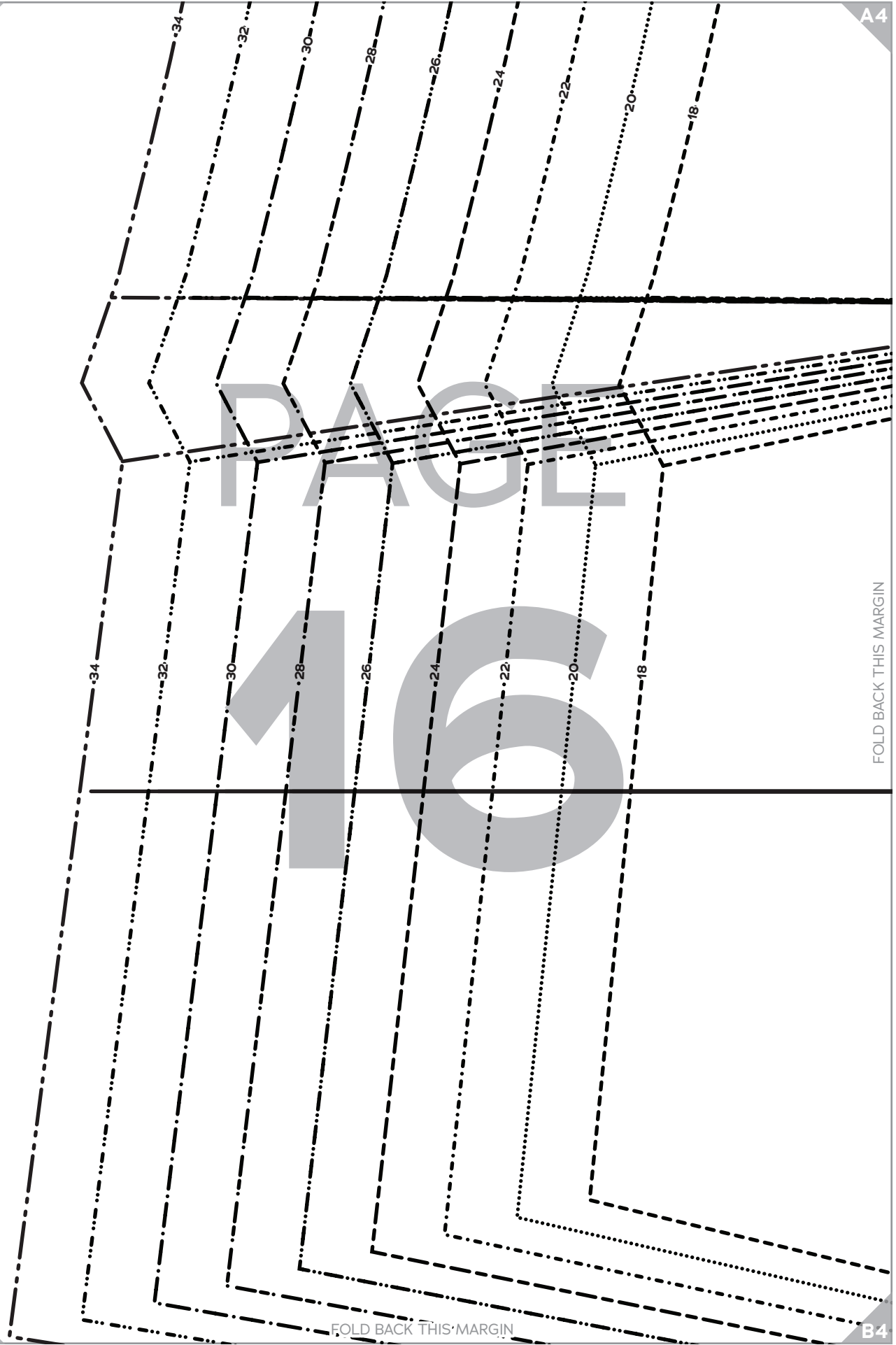

A4

A5

FOLD BACK THIS MARGIN

PAGE 17

34 32 30 28 26 24 22 20 18

B4

FOLD BACK THIS MARGIN

B5

A5

A6

N/LINE

1
Bodice
Front,
C Cup
Cut 2 fabric

● ●
LAPEL
TURNOUT
POINT

PAGE

18

SHORTEN/LENGTHEN LINE

18 ● 20
22 ● 24
26 ● 28
30 ● 32
34 ●

FOLD BACK THIS MARGIN



18 ●
20 ●
22 ●
24 ●
26 ●
28 ●
30 ●
32 ●
34 ●

B5

FOLD BACK THIS MARGIN

B6

A6

A7

PAGE

19

FOLD BACK THIS MARGIN

B6

FOLD BACK THIS MARGIN

B7

A7

A8

FOLD BACK THIS MARGIN

PAGE

20

34 32 30 28 26 24 22 20 18



B7

FOLD BACK THIS MARGIN

B8

A8

A9

LINE

1
 Bodice
 Front,
 D/DD Cup
 Cut 2 fabric

●
 LAPEL
 TURNOUT
 POINT

PAGE

21

SHORTEN/LENGTHEN LINE

FOLD BACK THIS MARGIN

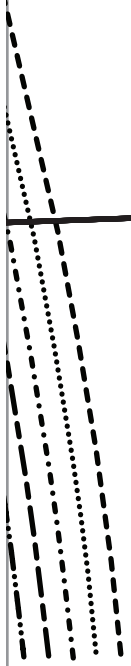

B8

B8

FOLD BACK THIS MARGIN

B9

A9

A10

LABEL

Bodice
Front,
F/G Cup
Cut 2 fabric



Scout Dress
SIZES 18-34



PAGE
22

CENTER FRONT

GRAINLINE

FOLD BACK THIS MARGIN

COLLAR
MATCH
POINT



B9

FOLD BACK THIS MARGIN

B10

PAGE
23

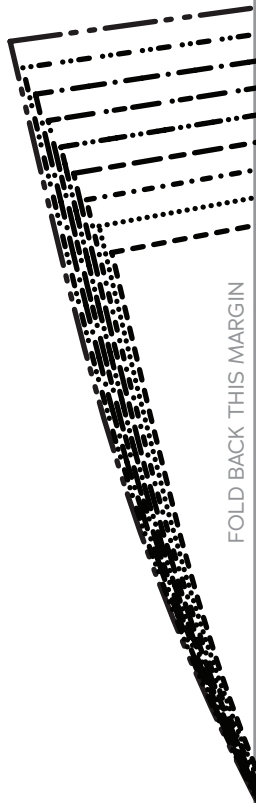
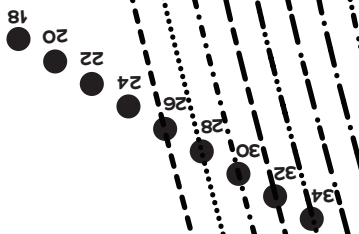

FOLD BACK THIS MARGIN

FOLD BACK THIS MARGIN

A11

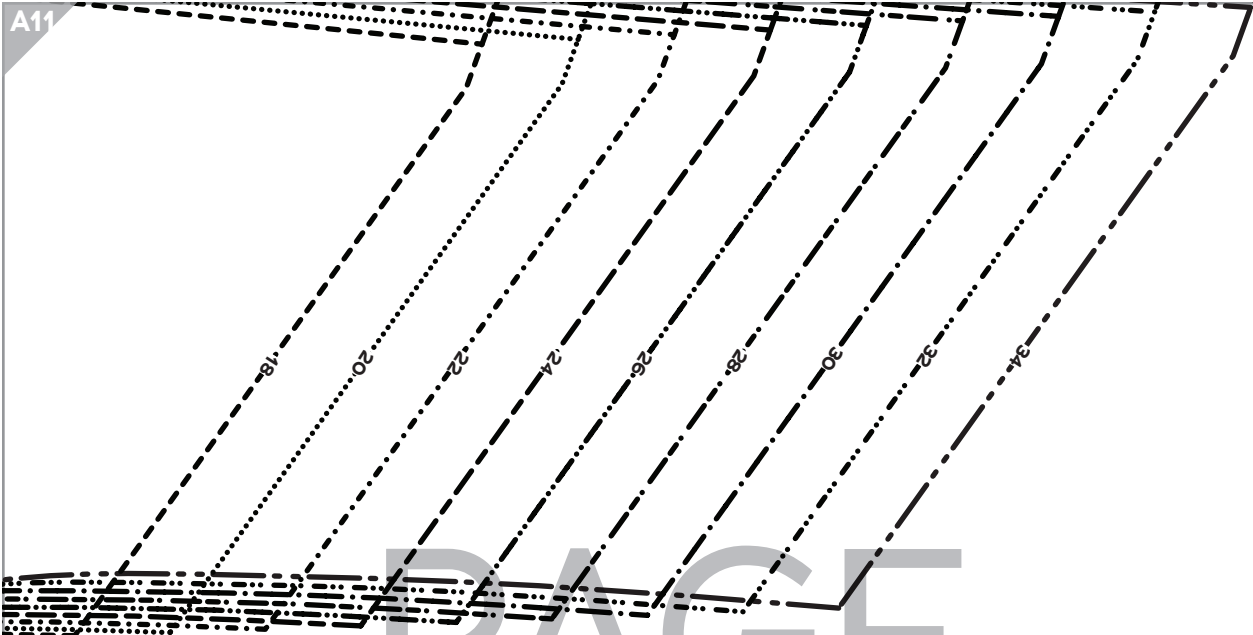

PAGE

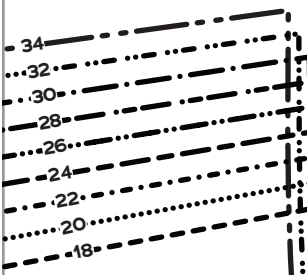

24

●
COLLAR
MATCH
POINT

B11



3

Bodice

B1

PAGE

25

FOLD BACK THIS MARGIN

FOLD BACK THIS MARGIN

C1

B1

B2

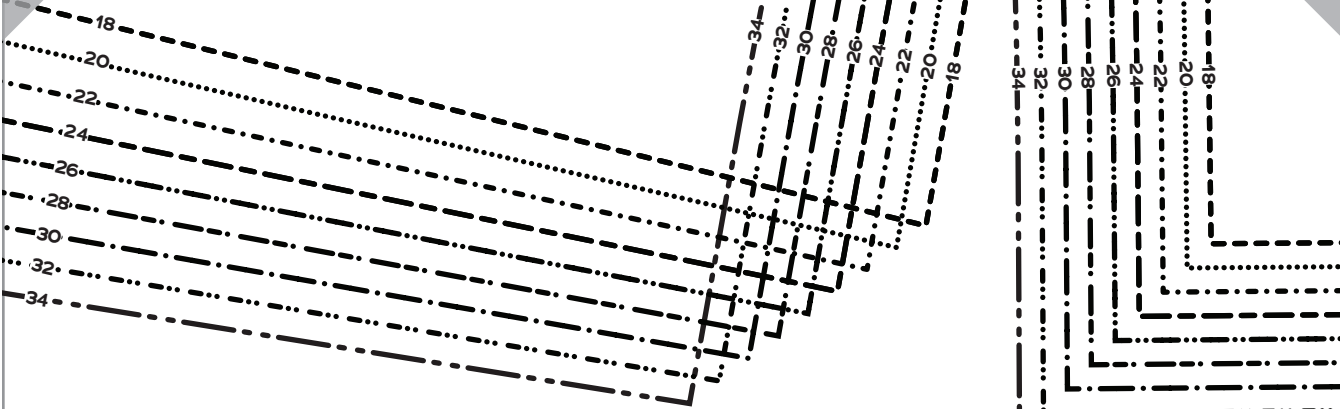

PAGE

26

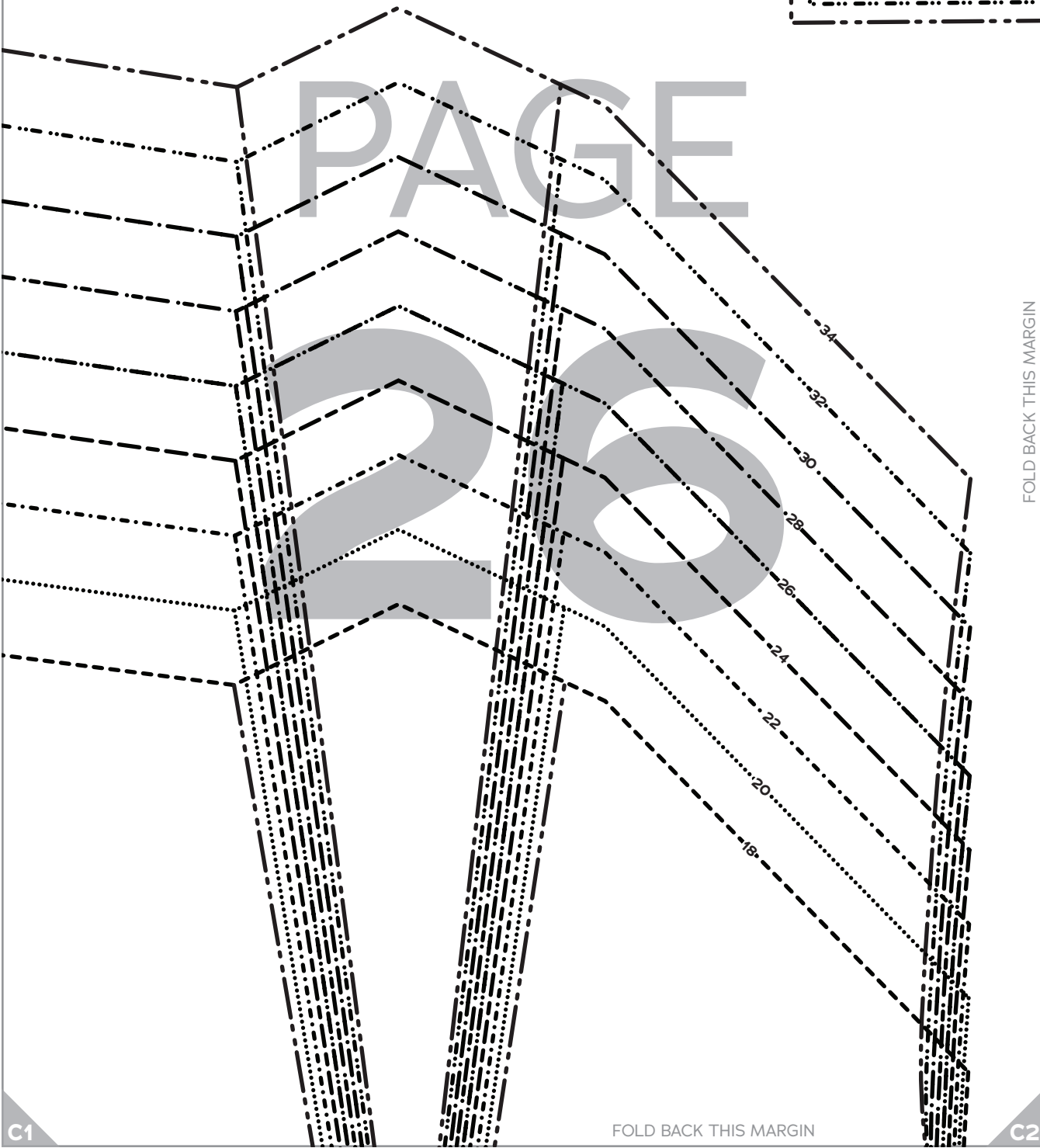

C1

FOLD BACK THIS MARGIN

C2

FOLD BACK THIS MARGIN

B2

B3

28
30
32
34

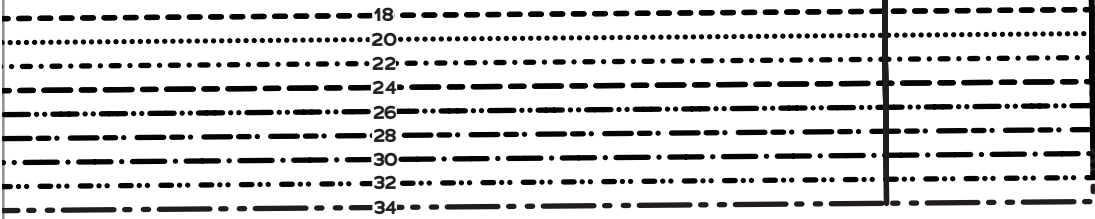

PAGE

FOLD

5
Collar

Scout Dress
SIZES 18-34

Cut 2 fabric on fold,
1 interfacing on fold

FOLD BACK THIS MARGIN

18 20 22 24 26 28 30 32 34

C2

FOLD BACK THIS MARGIN

C3

B3

B4

PAGE

288

18 20 22 24 26 28 30 32 34

FOLD BACK THIS MARGIN

C3

FOLD BACK THIS MARGIN

C4

B4

B5

26
28
30
32
4

PAGE

29

FOLD BACK THIS MARGIN

C4

FOLD BACK THIS MARGIN

C5

B5

B6

18
20
22
24
26
28
30
32
34

PAGE

30

FOLD BACK THIS MARGIN

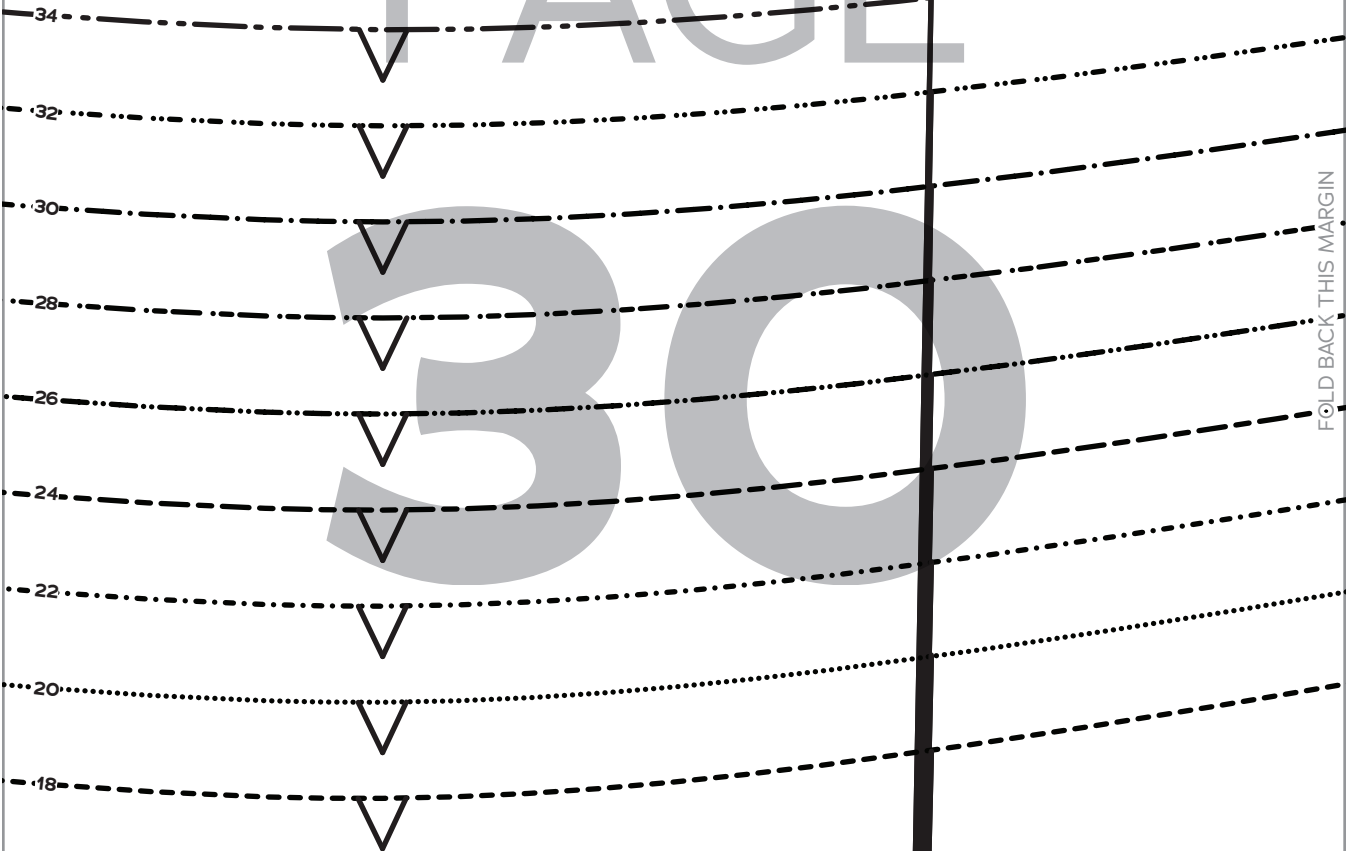

FOLD BACK THIS MARGIN

C5

C6

B6

B7

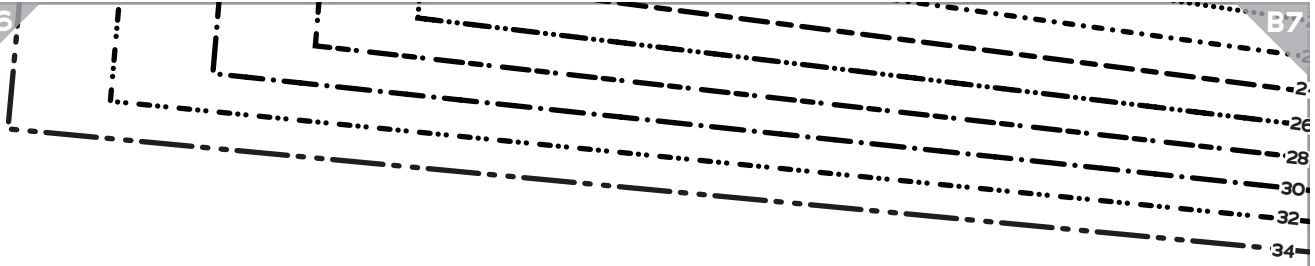

FOLD BACK THIS MARGIN

PAGE

31

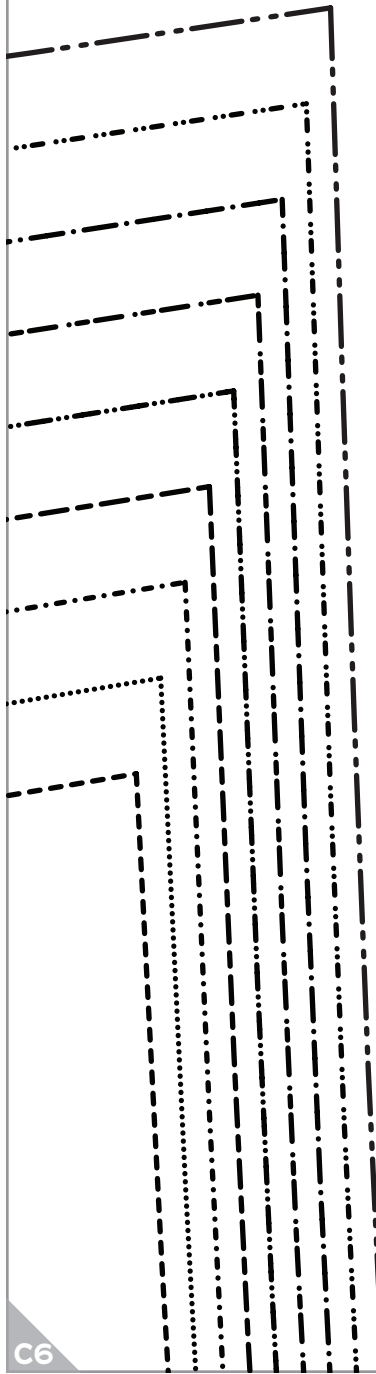
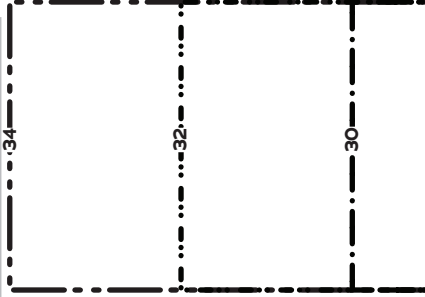

C6

FOLD BACK THIS MARGIN

C7

B7

B8

PAGE

32

28

26

24

22

20

18

FOLD BACK THIS MARGIN



C7

FOLD BACK THIS MARGIN

C8

B8

B9

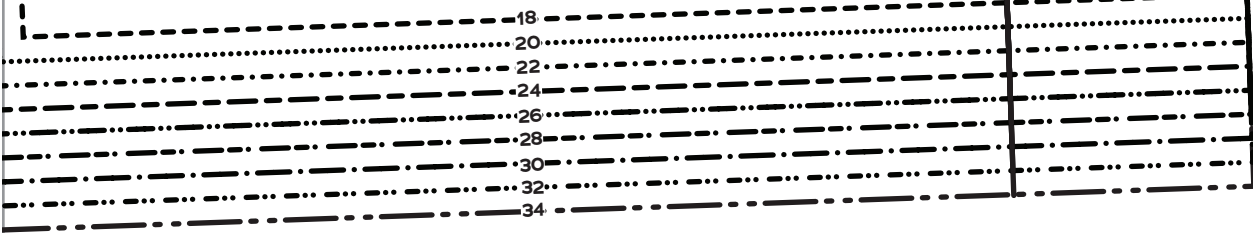

PAGE

FOLD BACK THIS MARGIN

33

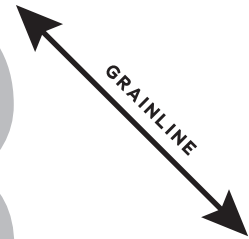

GRAINLINE

C8

FOLD BACK THIS MARGIN

C9

B9

B10

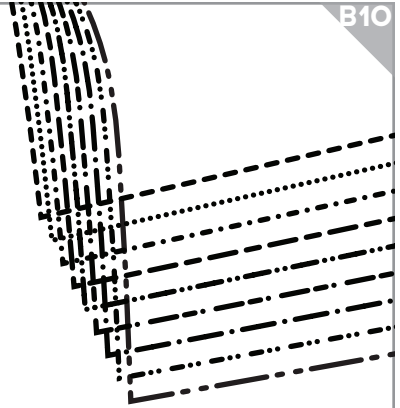

PAGE



9
Sleeveless Bias Facing
Cut 2 fabric

FOLD BACK THIS MARGIN

34



14
Skirt Front Interfacing
Cut 2 interfacing

C9

FOLD BACK THIS MARGIN

C10

B10

B11

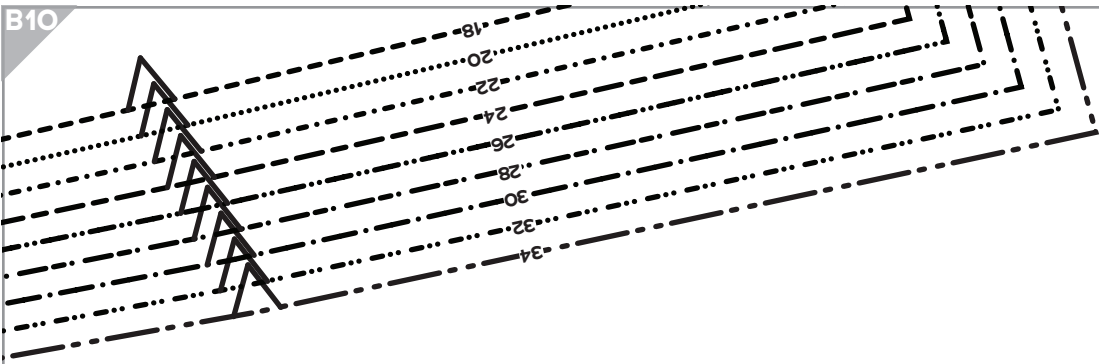

PAGE

35

FOLD BACK THIS MARGIN

C10

FOLD BACK THIS MARGIN

C11

B11



Scout Dress
SIZES 18-34

Scout Dress
Front Facing,
All Cups

Cut 2 fabric,
2 interfacing

PAGE
36

GRAINLINE

Scout Dress
SIZES 18-34

8
Sleeve Keyhole Binding
Cut 2 fabric



FOLD BACK THIS MARGIN

C11

FOLD BACK THIS MARGIN

SHORTEN/LENGTHEN LINE

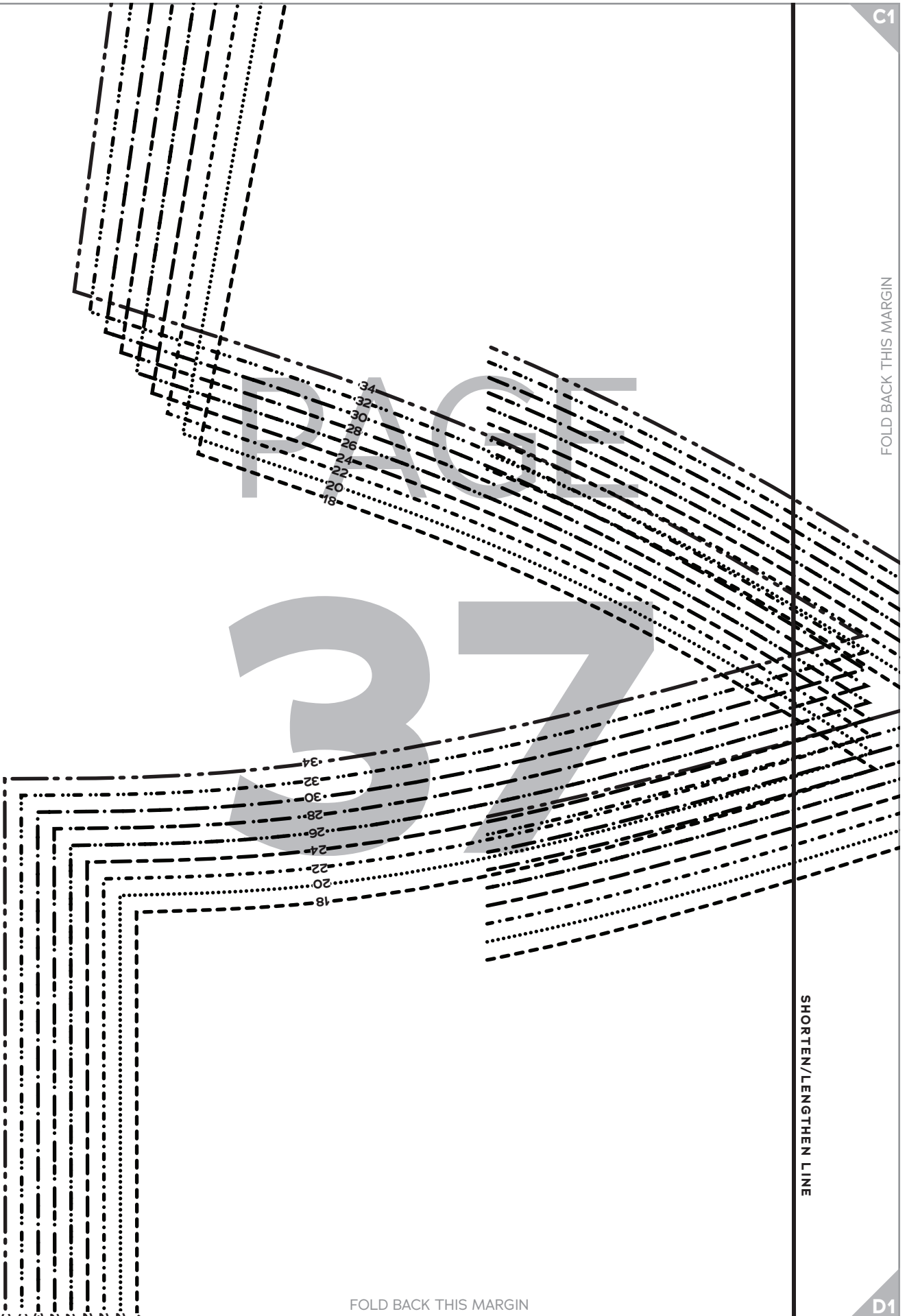

FOLD BACK THIS MARGIN

C1

C2

PAGE

38

FOLD BACK THIS MARGIN

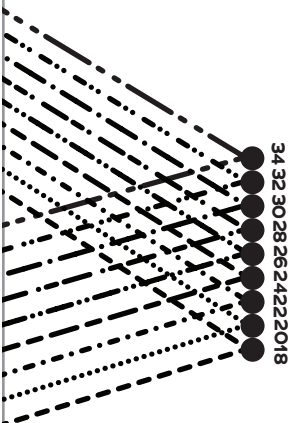

Scout Dress
 SIZES 18-34



Bodice
 Front,
 H Cup
 Cut 2 fabric

D1

FOLD BACK THIS MARGIN

D2

C2

C3

FOLD BACK THIS MARGIN

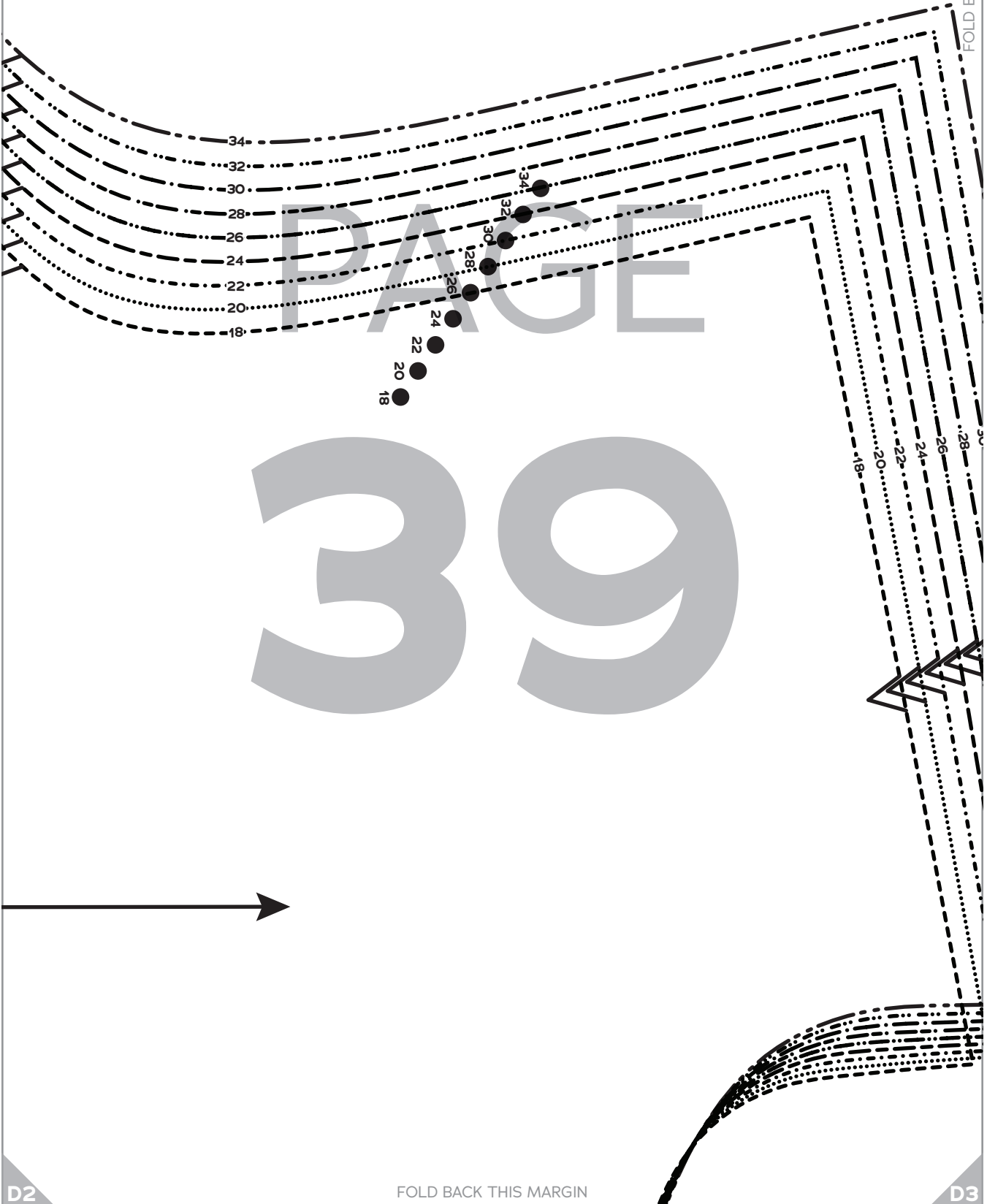

D2

FOLD BACK THIS MARGIN

D3

C3

C4

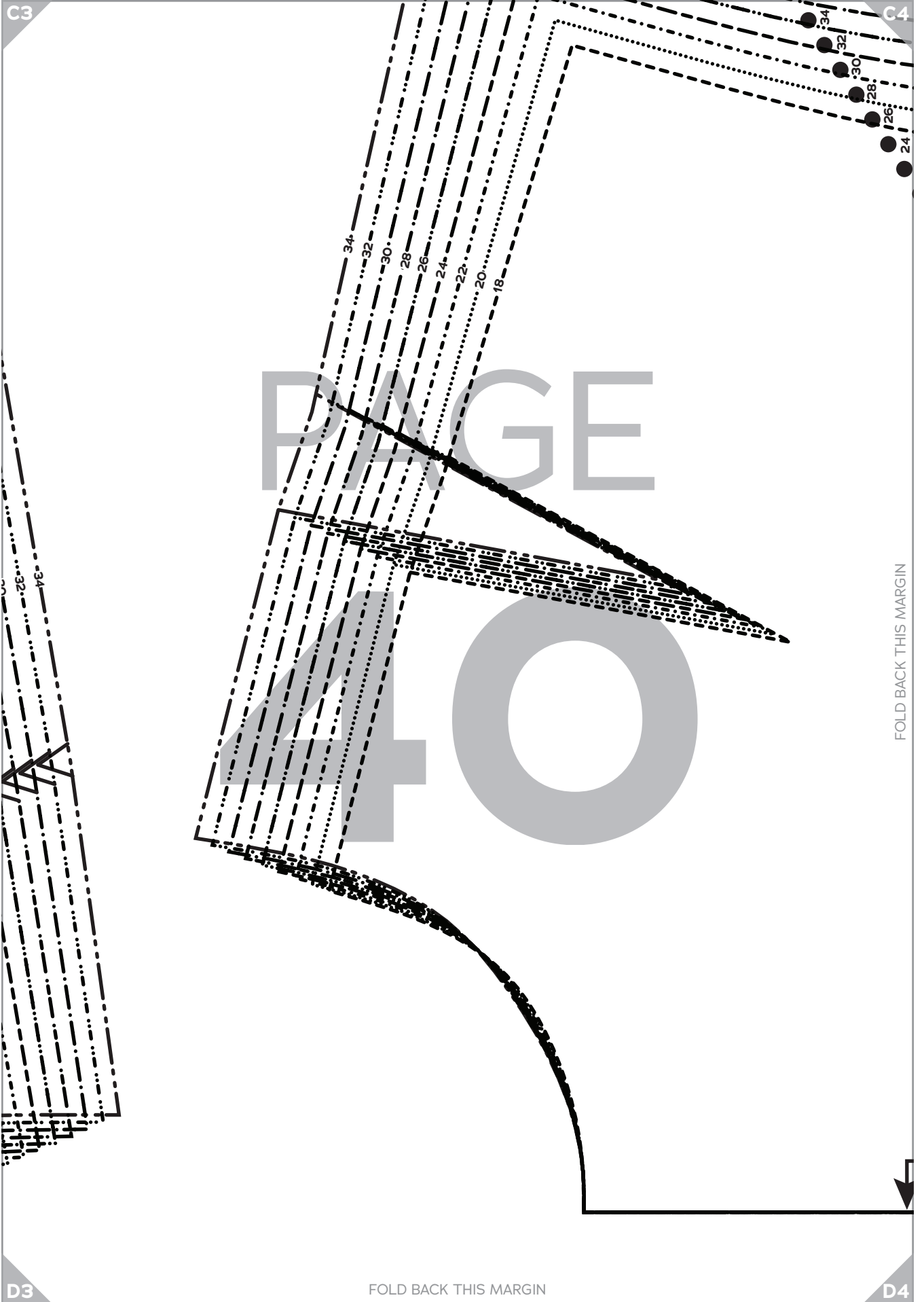

FOLD BACK THIS MARGIN

FOLD BACK THIS MARGIN

D3

D4

C4

22
20
18

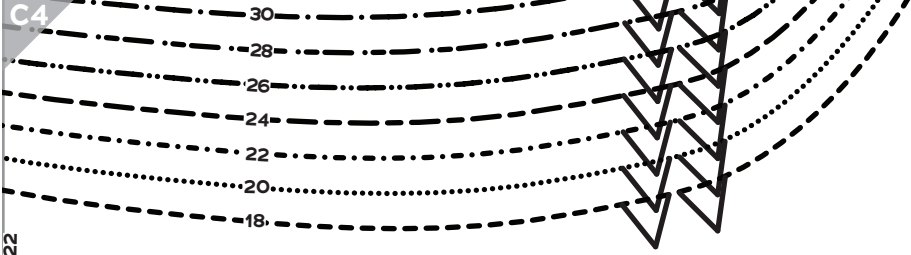

C5

PAGE



Scout Dress
SIZES 18-34

2

Bodice
Back

Cut 1 fabric on fold

FOLD BACK THIS MARGIN

18

FOLD

D4

FOLD BACK THIS MARGIN

D5

C5

C6

FOLD BACK THIS MARGIN

PAGE

42

20
22
24
26
28
30
32
34

SHORTEN/LENGTHEN LINE



D5

FOLD BACK THIS MARGIN

D6

C6

C7

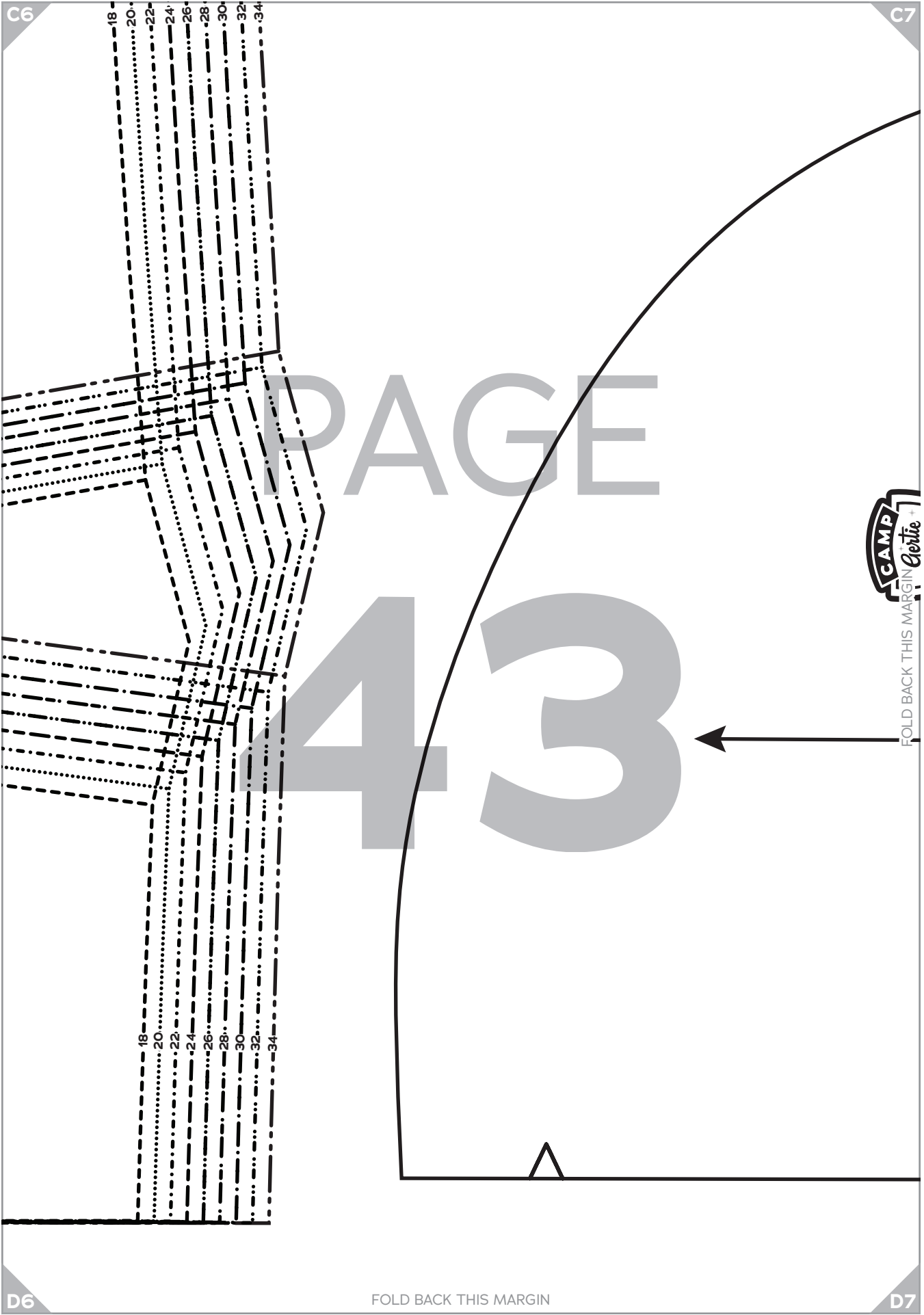

D6

D7

FOLD BACK THIS MARGIN

C7

C8



Scout Dress

SIZES 18-34

13

Pocket Bag
Cut 4 fabric

PAGE

44

GRAINLINE



FOLD BACK THIS MARGIN

D7

FOLD BACK THIS MARGIN

D8

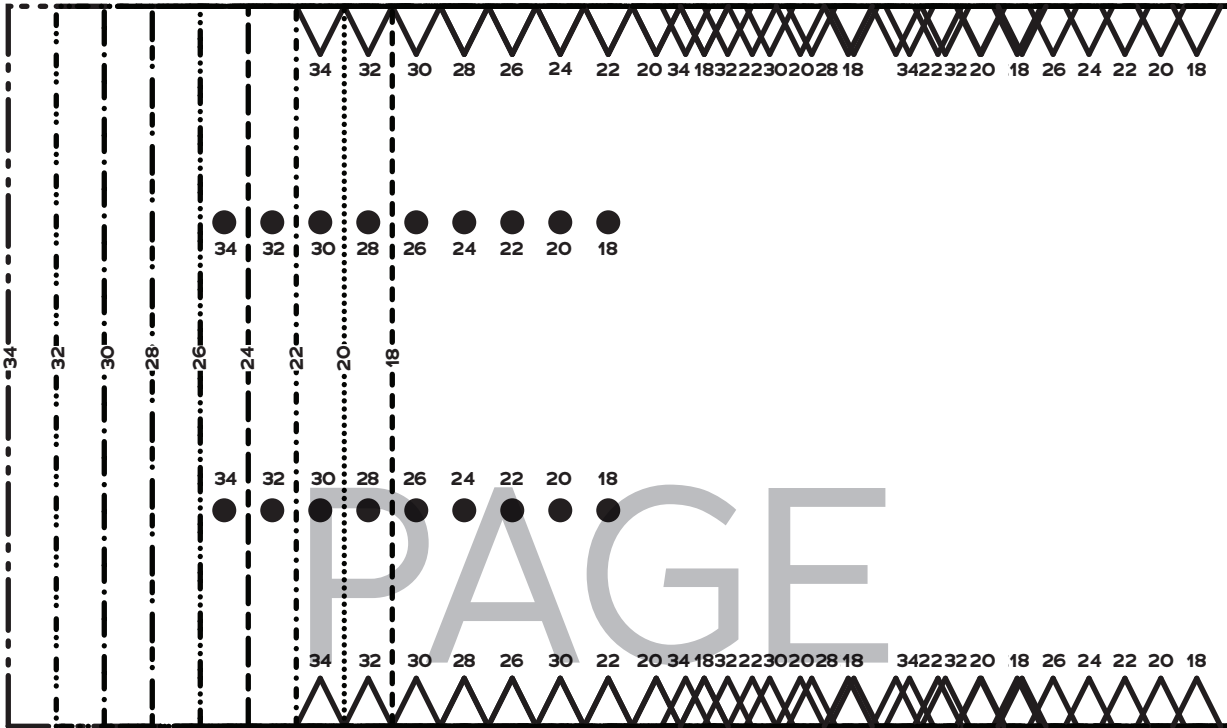

FOLD BACK THIS MARGIN

45

FOLD BACK THIS MARGIN

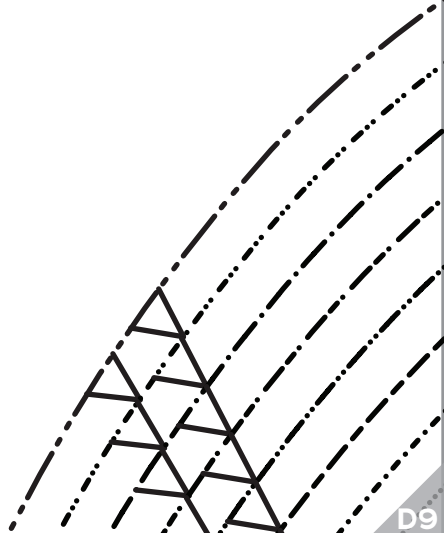

GRAINLINE



Scout Dress
SIZES 18-34

7
Sleeve
Band
Cut 2 fabric,
2 interfacing

FOLD BACK THIS MARGIN

PAGE

46

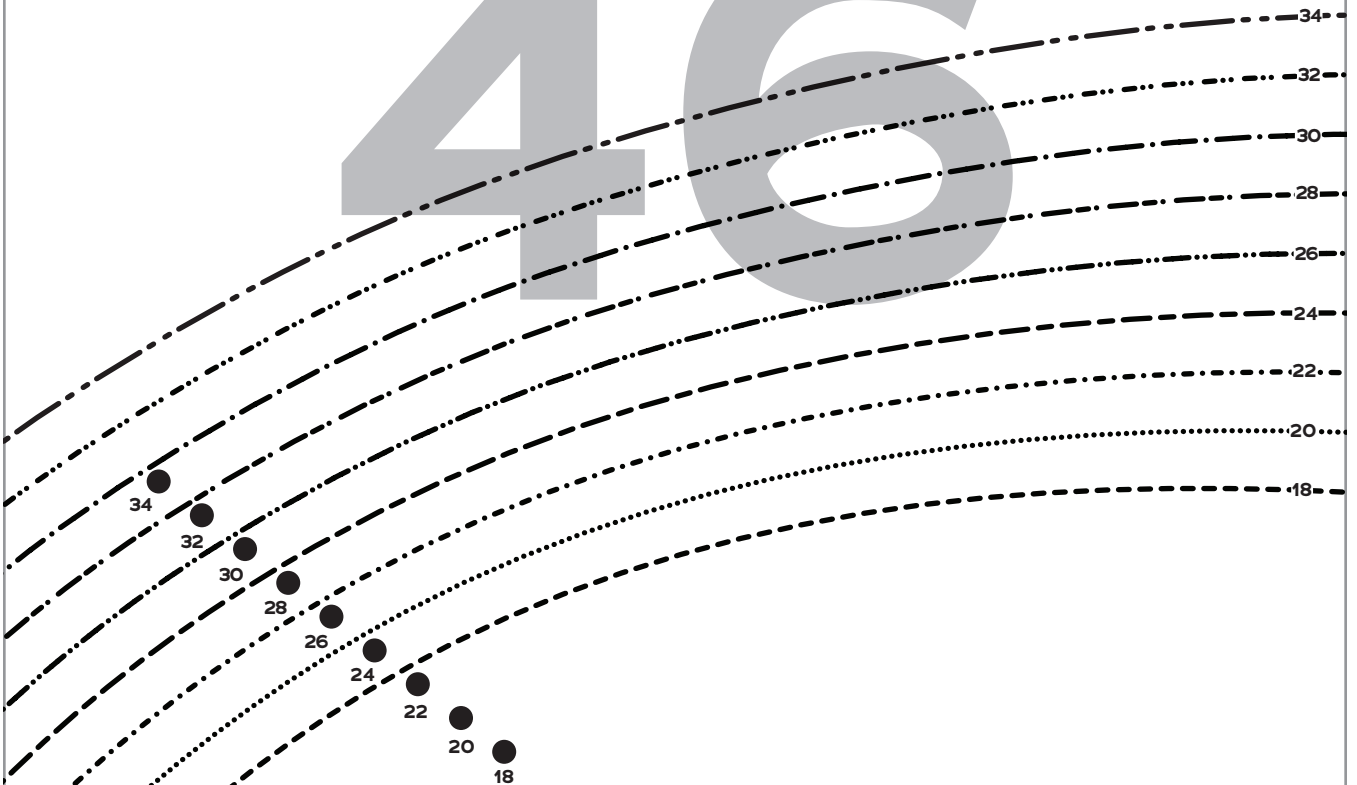



PAGE



47

FOLD BACK THIS MARGIN

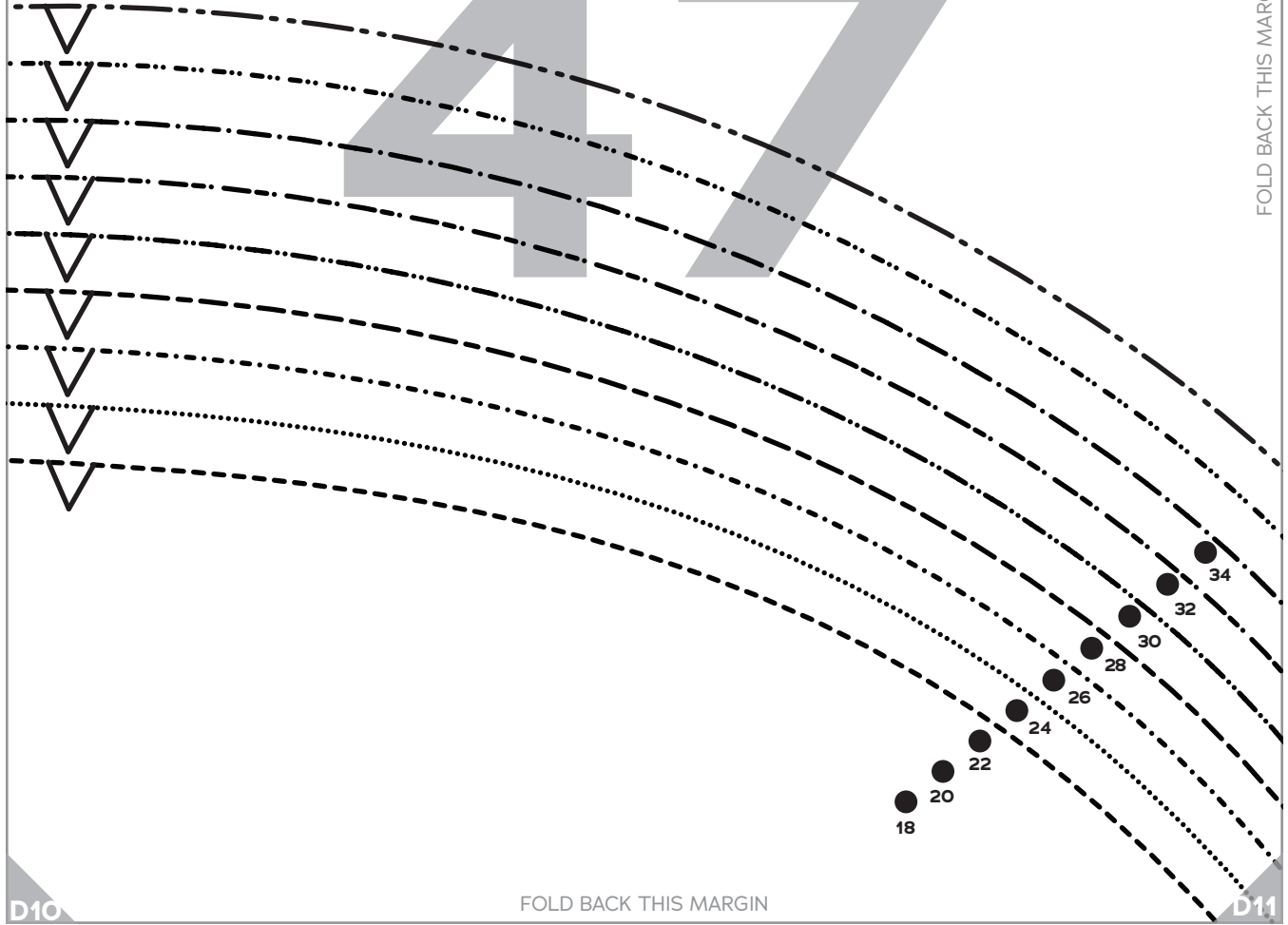

C11

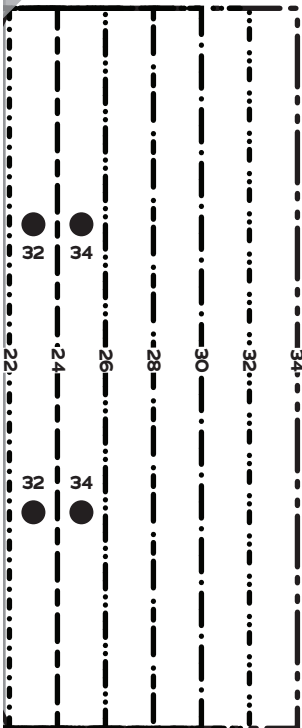

PAGE

48

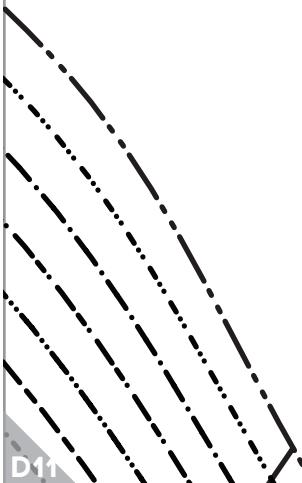

FOLD BACK THIS MARGIN

D1

FOLD BACK THIS MARGIN

18
20
22
24
26
28
30
32
34

18
20
22
24
26
28
30
32
34

8
0
2
4
6
8
0
2
4

PAGE 49

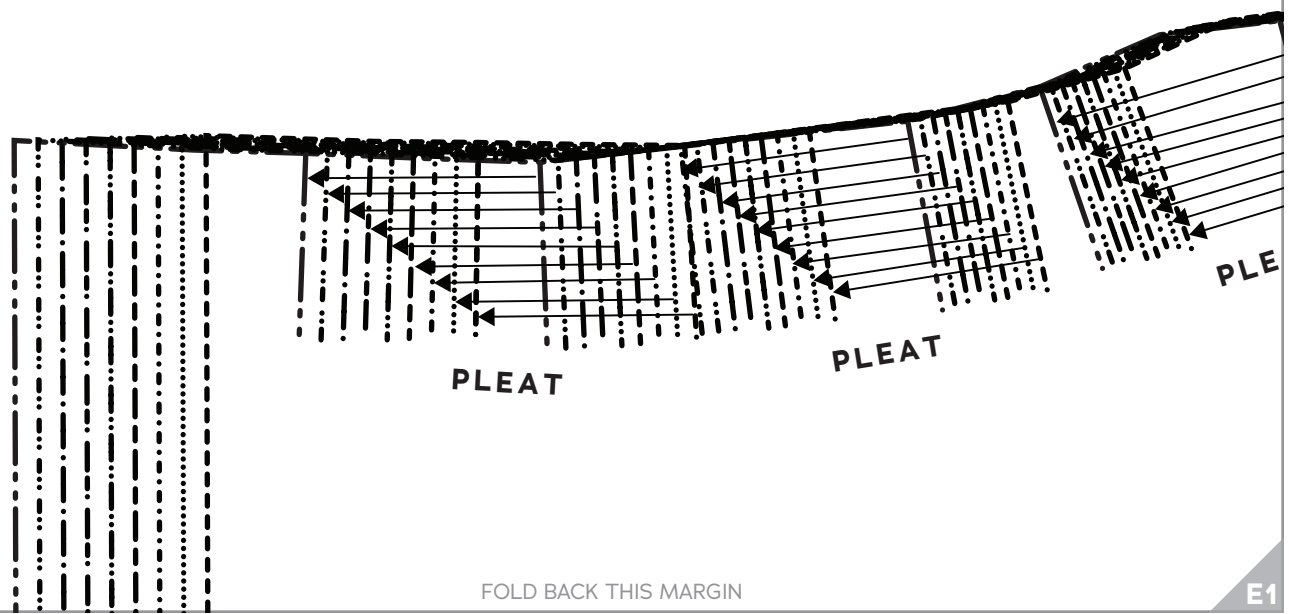

FOLD BACK THIS MARGIN

E1

D1

D2

CENTER FRONT

LAPEL
TURNOUT
POINT

PAGE

50

PLEAT

FOLD BACK THIS MARGIN

AT

FOLD BACK THIS MARGIN

E1

E2

D2

D3

COLLAR
MATCH
POINT



PAGE

51

FOLD BACK THIS MARGIN

E2

FOLD BACK THIS MARGIN

E3

D3

D4

PAGE

52

FOLD BACK THIS MARGIN

FOLD BACK THIS MARGIN

E3

E4

D4

D5

PAGE

53

FOLD BACK THIS MARGIN

E4

FOLD BACK THIS MARGIN

E5

D5

D6

PAGE

54

FOLD BACK THIS MARGIN

E5

FOLD BACK THIS MARGIN



E6

D6

D7

PAGE

55

FOLD BACK THIS MARGIN

E6

FOLD BACK THIS MARGIN

E7

D7

D8

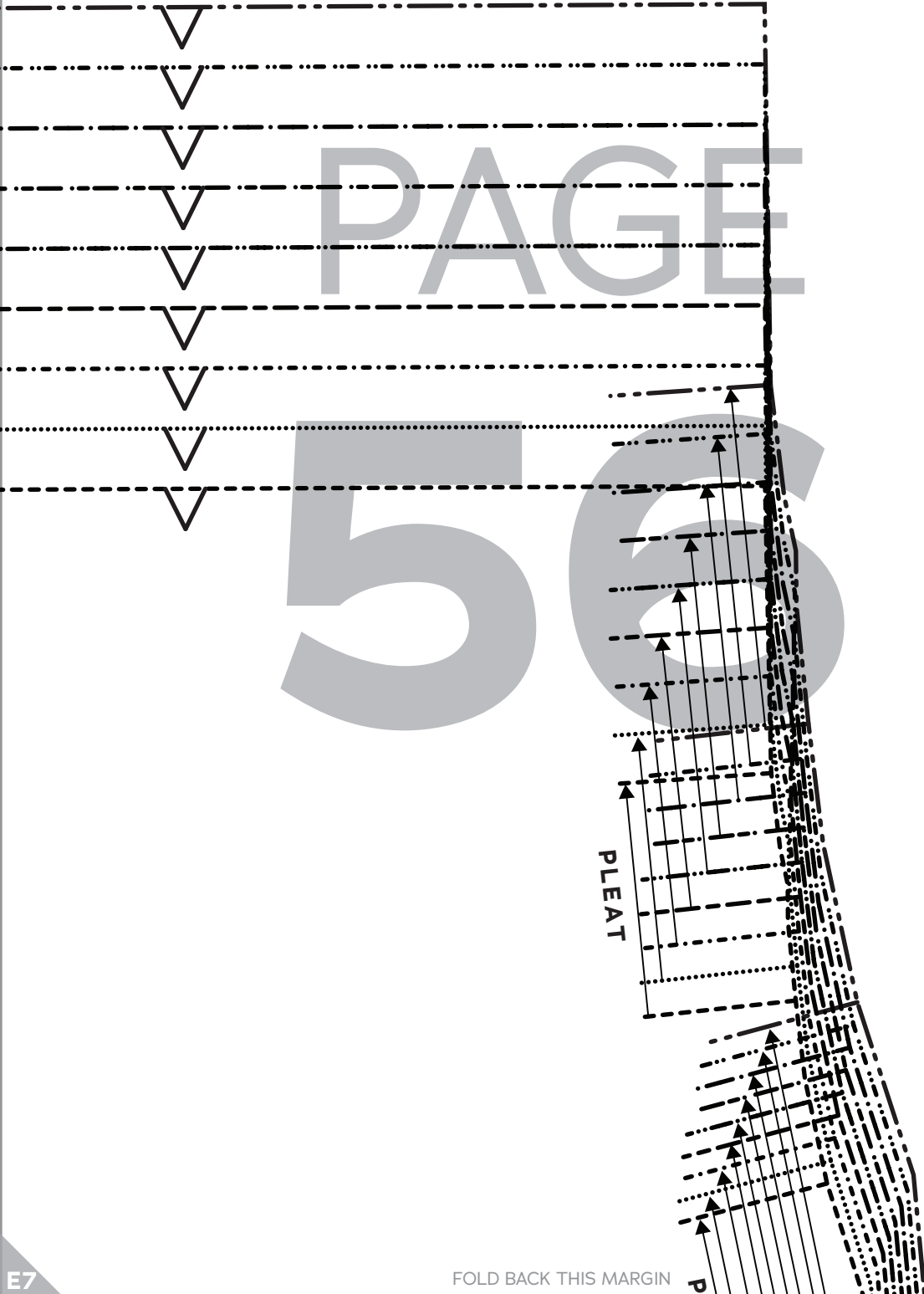

PAGE

56

FOLD BACK THIS MARGIN

PLEAT

FOLD BACK THIS MARGIN

E7

E8

D8

D9

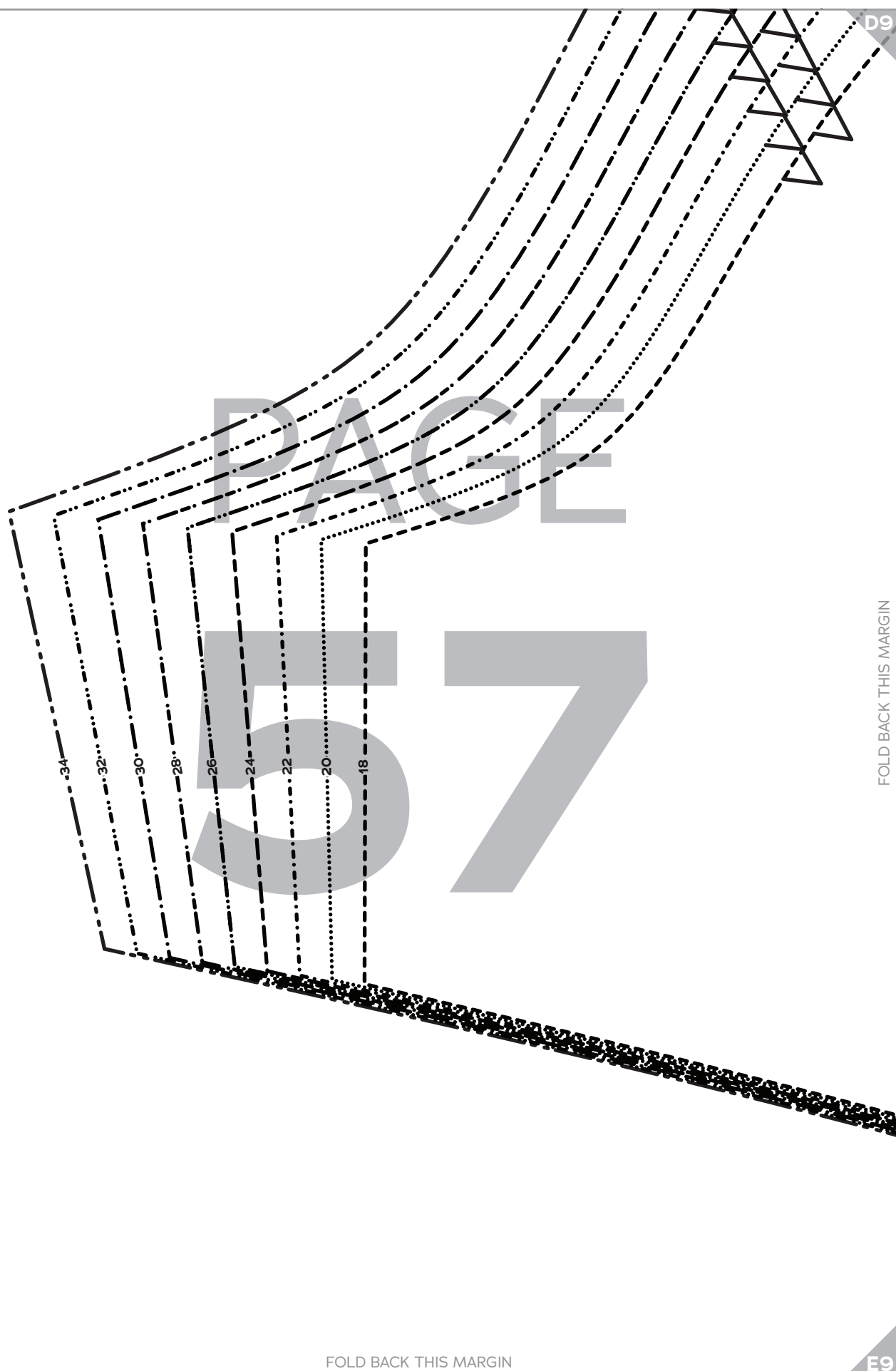

PAGE

57

FOLD BACK THIS MARGIN

E8

FOLD BACK THIS MARGIN

E9

D9

D10

PAGE 58



GRAINLINE

FOLD BACK THIS MARGIN

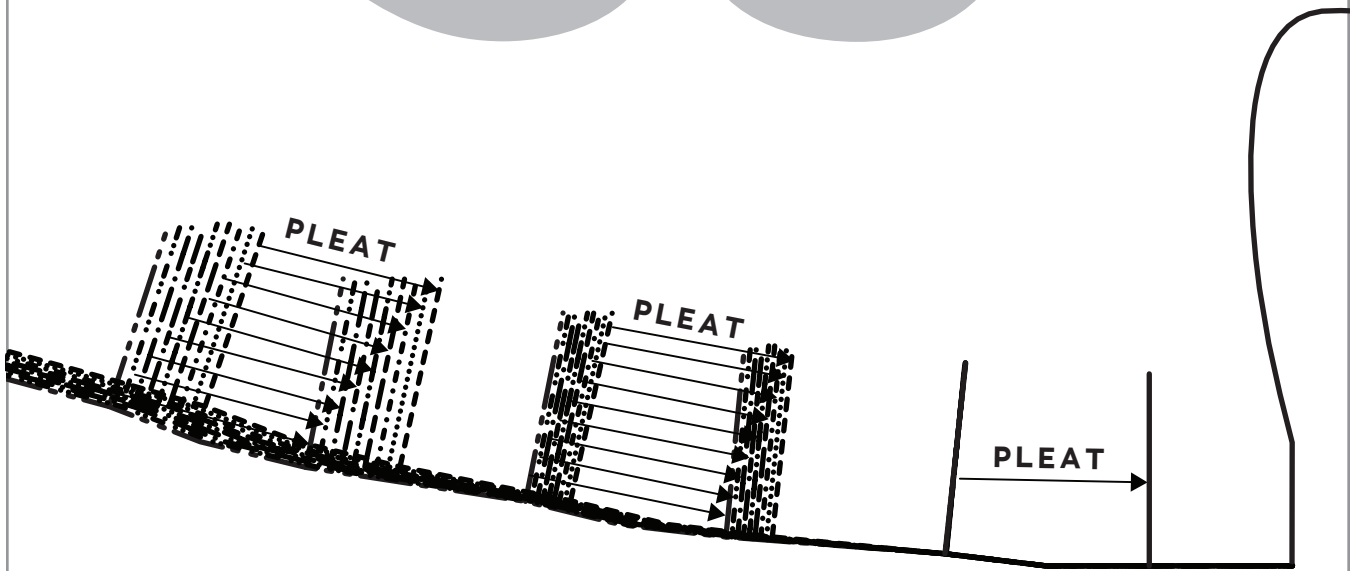

E9

FOLD BACK THIS MARGIN

E10

D10

D11



Scout Dress

SIZES 18-34

6
Sleeve
Cut 2 fabric

PAGE

59

FOLD BACK THIS MARGIN

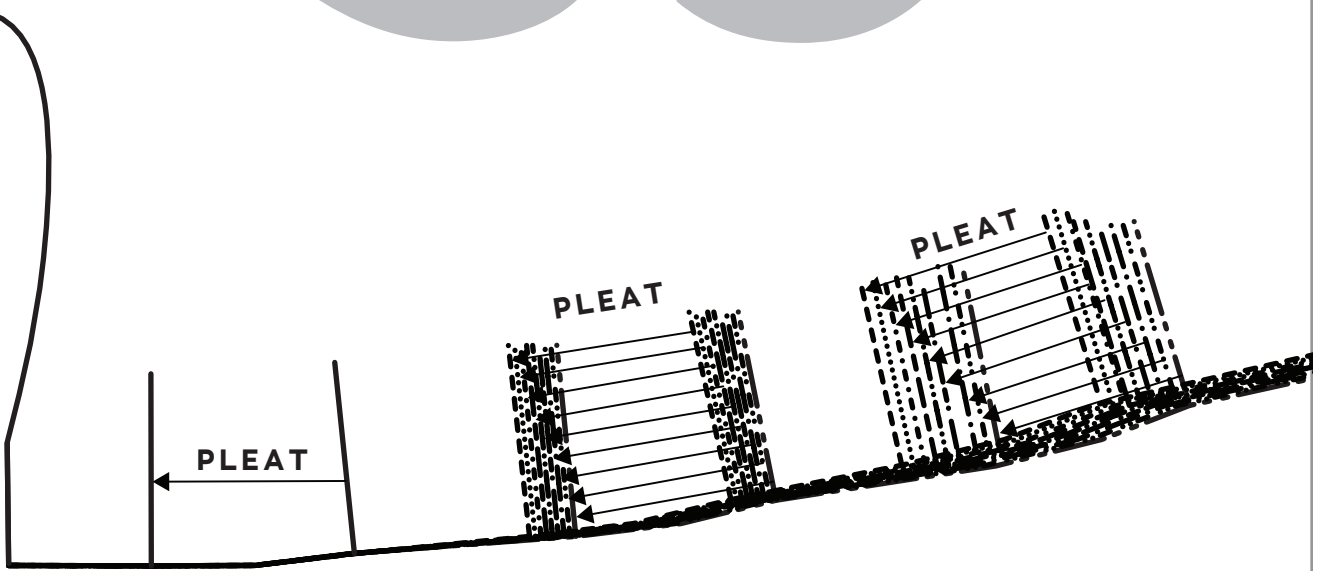

E10

FOLD BACK THIS MARGIN

E11

D11

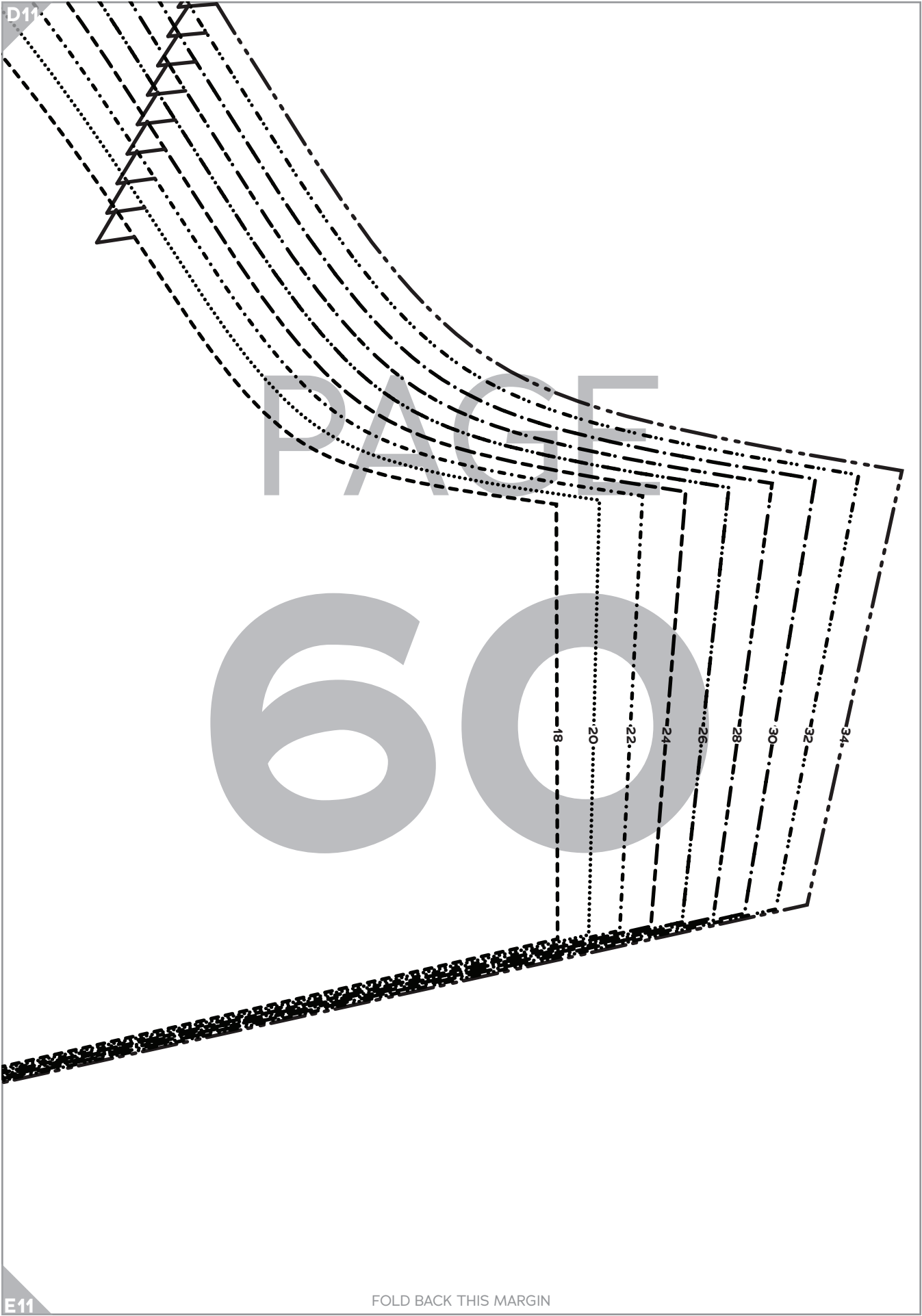

E11



PAGE 61

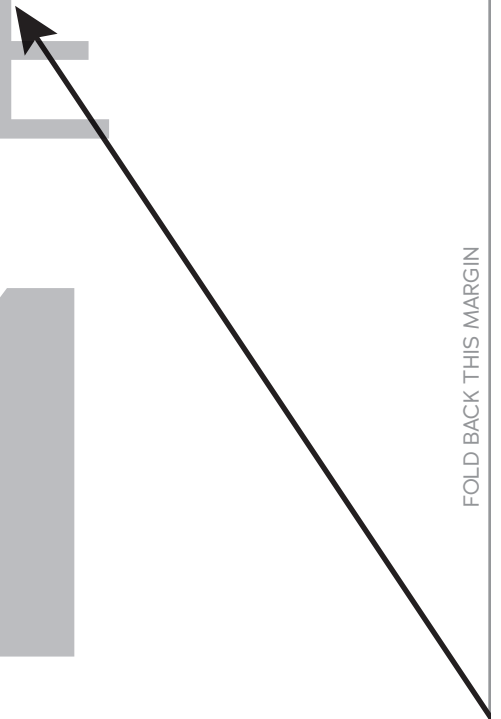

FOLD BACK THIS MARGIN

FOLD BACK THIS MARGIN

E1

E2

PAGE

62

FOLD BACK THIS MARGIN



Scout Dress
SIZES 18-34

10
Skirt
Front
Cut 2 fabric

GRAIN LINE

F1

FOLD BACK THIS MARGIN

F2

E2

E3

PAGE

18
26
34

CENTER FRONT/FOLD LINE

FOLD BACK THIS MARGIN

18
26
34

F2

FOLD BACK THIS MARGIN

F3

E3

E4

PAGE
64

FOLD BACK THIS MARGIN

F3

FOLD BACK THIS MARGIN

F4

E4

E5

PAGE 65

FOLD BACK THIS MARGIN

F4

FOLD BACK THIS MARGIN

F5

E5

E6

PAGE

66

GRAINLINE



Scout Dress
SIZES 18-34

11
Skirt Side
Front/Back
Cut 4 fabric

FOLD BACK THIS MARGIN

F5

FOLD BACK THIS MARGIN

F6

E6

E7

PAGE

67

FOLD BACK THIS MARGIN

F6

FOLD BACK THIS MARGIN

F7

E7

E8

LEAT
FOLD PLEATS TOWARD
SIDE SEAMS

PLEAT

PLEAT

FOLD BACK THIS MARGIN

PAGE 68

F7

FOLD BACK THIS MARGIN

F8

E8

E9

PAGE

69

FOLD BACK THIS MARGIN

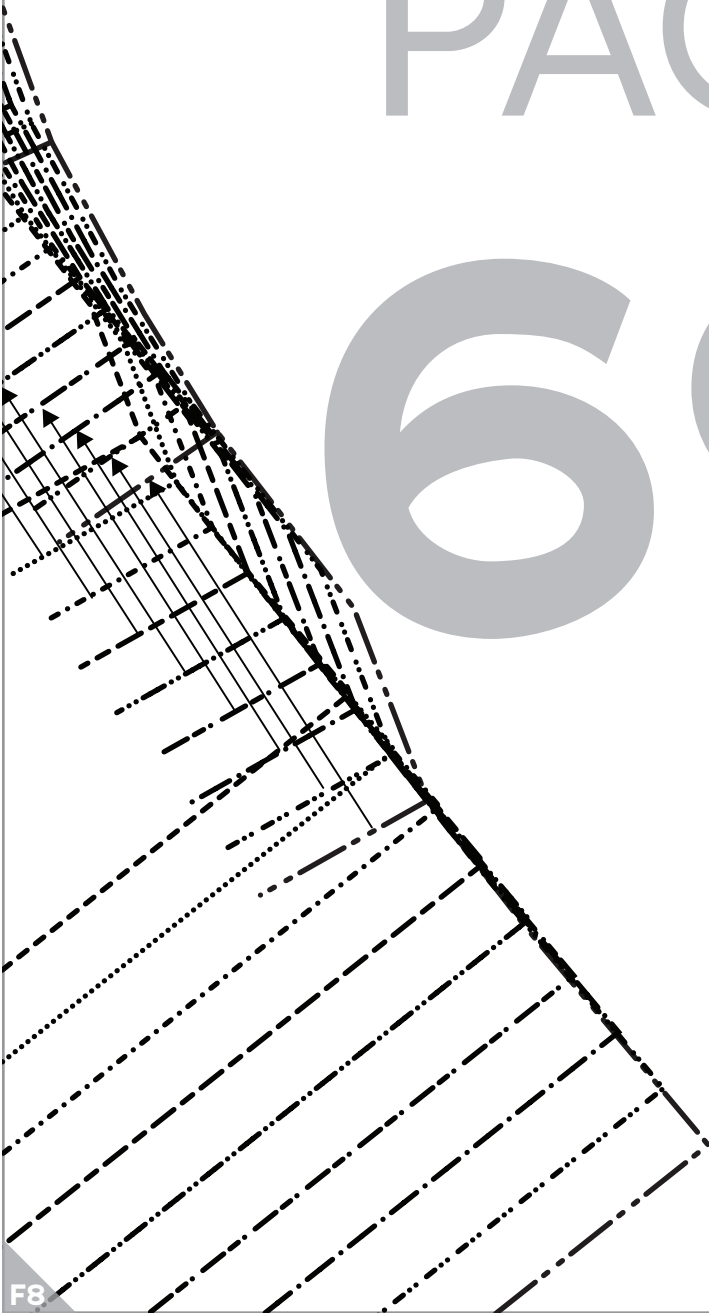

F8

FOLD BACK THIS MARGIN

F9

E9

E10

PAGE 70

FOLD BACK THIS MARGIN

F9

FOLD BACK THIS MARGIN

F10

E10

E11

PAGE

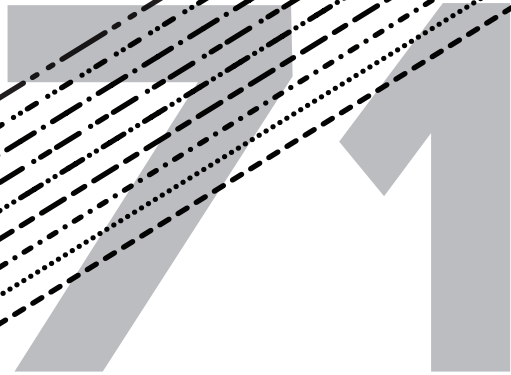

FOLD BACK THIS MARGIN

F10

FOLD BACK THIS MARGIN

F11

PAGE

72

34
32
30
28
26
24
22
20
18

PAGE 73

FOLD BACK THIS MARGIN

FOLD BACK THIS MARGIN

F1

F2

PAGE

74

FOLD BACK THIS MARGIN

G1

FOLD BACK THIS MARGIN

G2

F2

F3

18
20
22
24
26
28
30
32
34

PAGE 75

FOLD BACK THIS MARGIN

G2

FOLD BACK THIS MARGIN

G3

F3

F4

2

PAGE

FOLD BACK THIS MARGIN

18	20
22	24
26	28
30	32
34	

76

G3

FOLD BACK THIS MARGIN

G4

F4

F5

PAGE

77

FOLD BACK THIS MARGIN

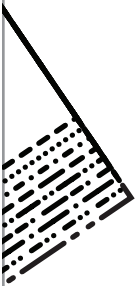

G4

FOLD BACK THIS MARGIN

G5

F5

F6

PAGE

78



FOLD BACK THIS MARGIN

G5

FOLD BACK THIS MARGIN

G6

PAGE

79

FOLD BACK THIS MARGIN

F7

F8

PAGE

80

FOLD BACK THIS MARGIN

FOLD BACK THIS MARGIN

G7

G8

F8

F9

PAGE

81

34
32
30
28
26
24
22
20
18

FOLD BACK THIS MARGIN

G8

FOLD BACK THIS MARGIN

G9

F9

F10

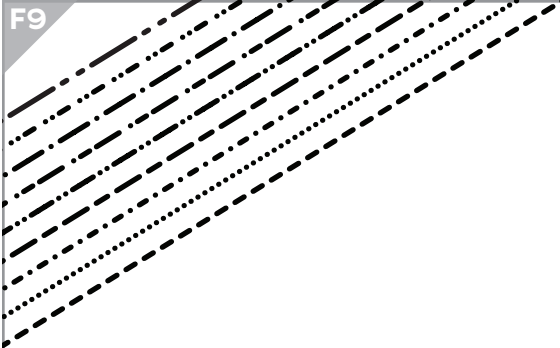

PAGE

82

FOLD BACK THIS MARGIN

G9

FOLD BACK THIS MARGIN

G10

F10

F11

PAGE

83

FOLD BACK THIS MARGIN

G10

FOLD BACK THIS MARGIN

G11

PAGE

84

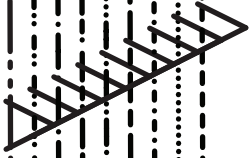

PAGE

85

FOLD BACK THIS MARGIN

PAGE

86

FOLD BACK THIS MARGIN

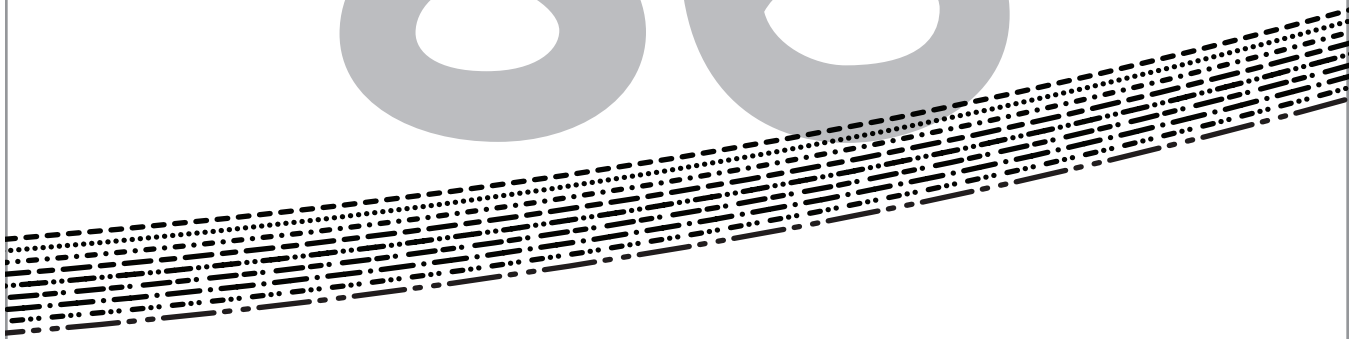

FOLD BACK THIS MARGIN

PAGE

87

G3

G4

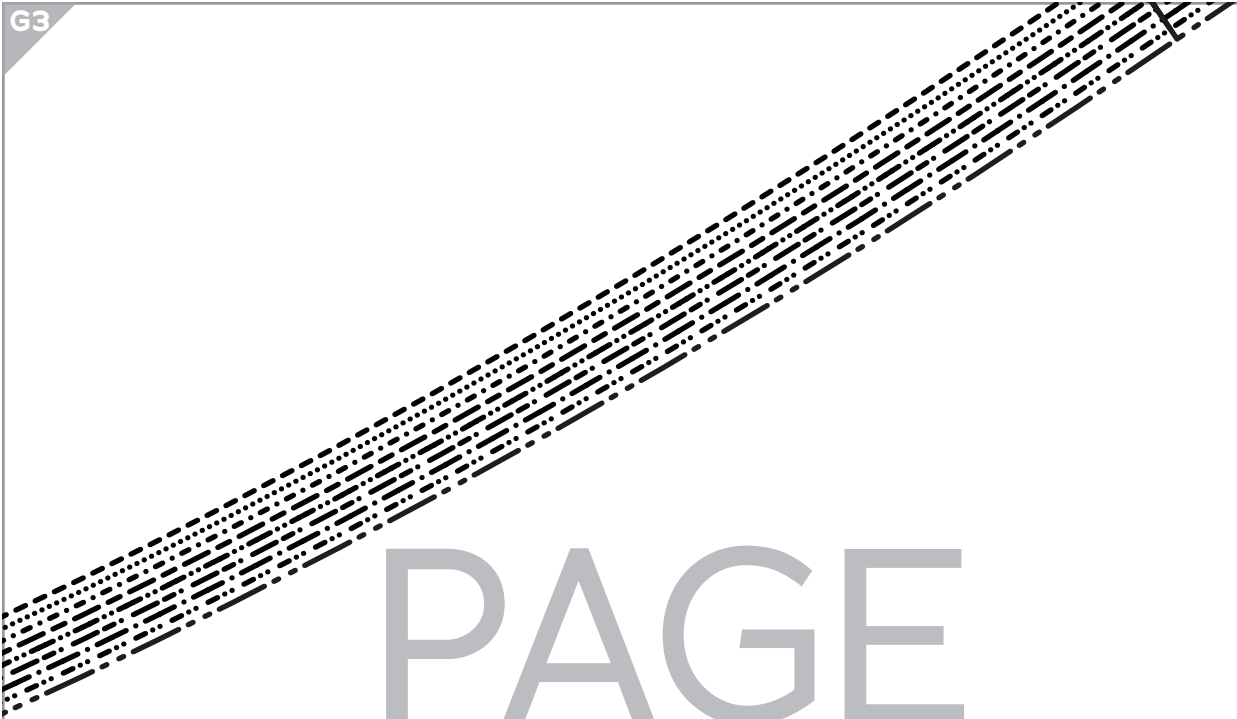

PAGE

88

FOLD BACK THIS MARGIN

PAGE 89

FOLD BACK THIS MARGIN

PAGE

90

FOLD BACK THIS MARGIN

G6

G7

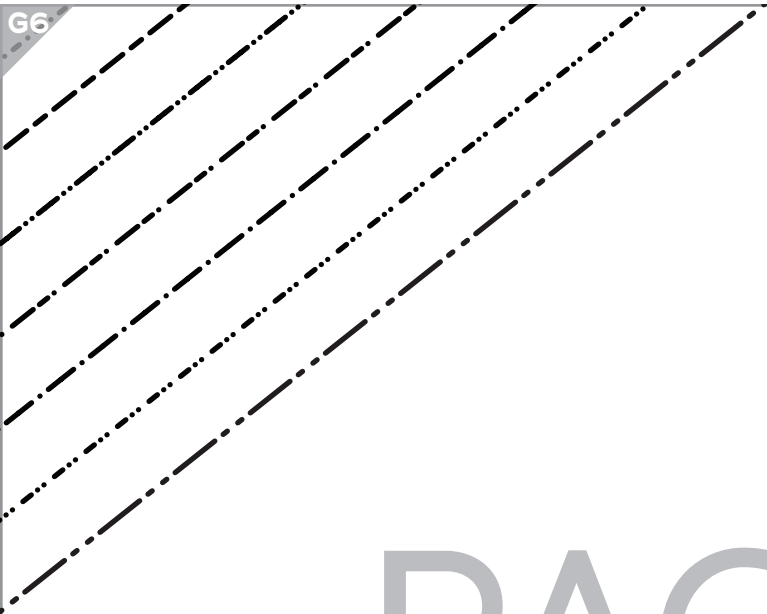

PAGE

91

FOLD BACK THIS MARGIN

PAGE 92



FOLD BACK THIS MARGIN

PAGE

93

FOLD BACK THIS MARGIN





Scout Dress

SIZES 18-34

12

Skirt
Back

Cut 1 fabric on fold

PAGE

94

FOLD BACK THIS MARGIN

FOLD

PAGE 95

FOLD BACK THIS MARGIN

PAGE 96

