

Society

DRESS



Sizes 18-34
with cup sizes A-H

5/8 inch (in) (1.5 cm) seam allowances are included on all pattern pieces.

SIZES 18-34
PATTERN
SIZE KEY

18	-----
20
22
24	-----
26
28	-----
30	-----
32
34	-----

SYMBOL KEY

grainline arrow



match point/
placement mark



PAGE

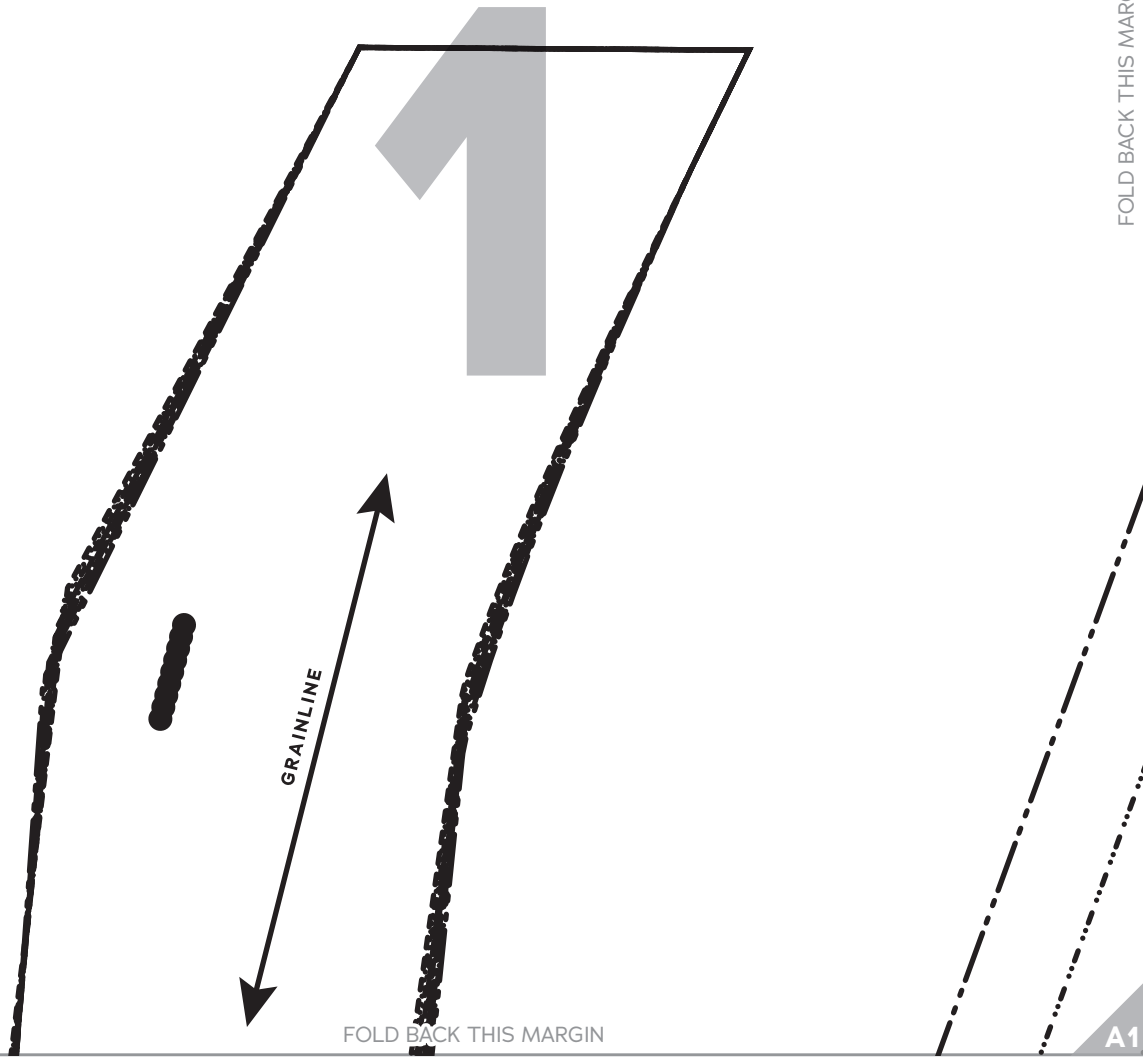
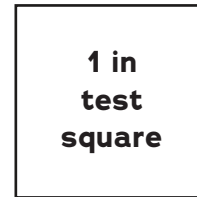
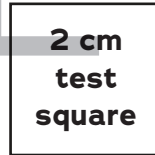

FOLD BACK THIS MARGIN

FOLD BACK THIS MARGIN

A1

PAGE

2

FOLD BACK THIS MARGIN

A1

FOLD BACK THIS MARGIN

A2



PAGE

3

FOLD BACK THIS MARGIN

A2

FOLD BACK THIS MARGIN

A3

PAGE

4

FOLD BACK THIS MARGIN

A3

FOLD BACK THIS MARGIN

A4

PAGE

5

FOLD BACK THIS MARGIN

A4

FOLD BACK THIS MARGIN

A5

PAGE

6

FOLD BACK THIS MARGIN

A5

FOLD BACK THIS MARGIN

A6

PAGE

7

FOLD BACK THIS MARGIN

A6

FOLD BACK THIS MARGIN

A7

PAGE

8

FOLD BACK THIS MARGIN

A7

FOLD BACK THIS MARGIN

A8

PAGE

9

FOLD BACK THIS MARGIN

A8

FOLD BACK THIS MARGIN

A9

PAGE 10

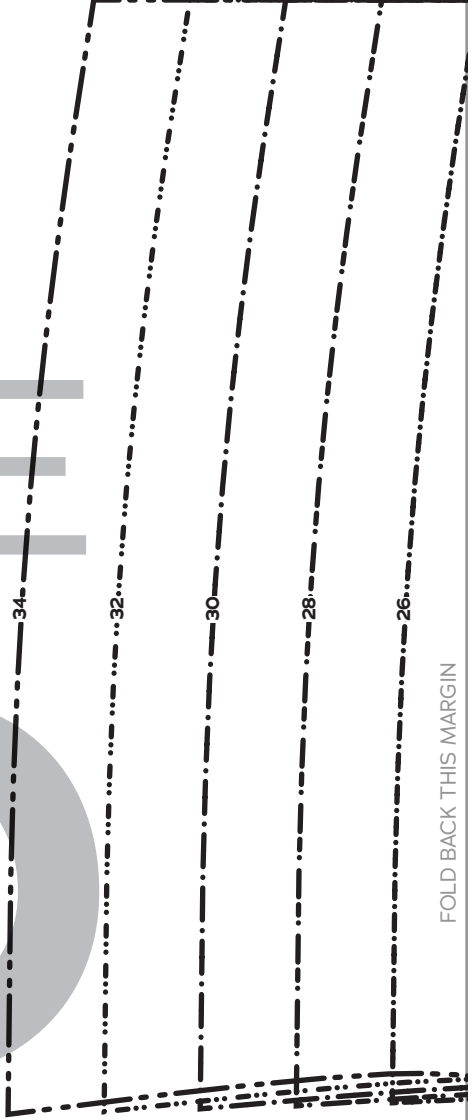

FOLD BACK THIS MARGIN

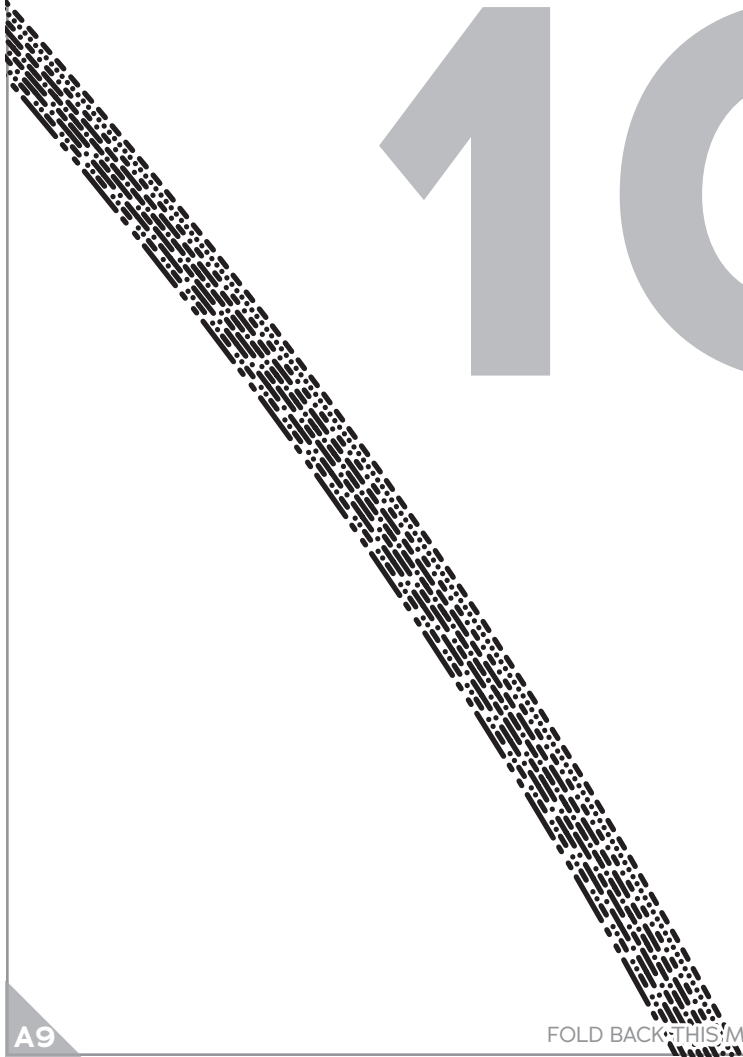

FOLD BACK THIS MARGIN

A9

A10

TWEEN CIRCLES

PAGE

11

FOLD BACK THIS MARGIN

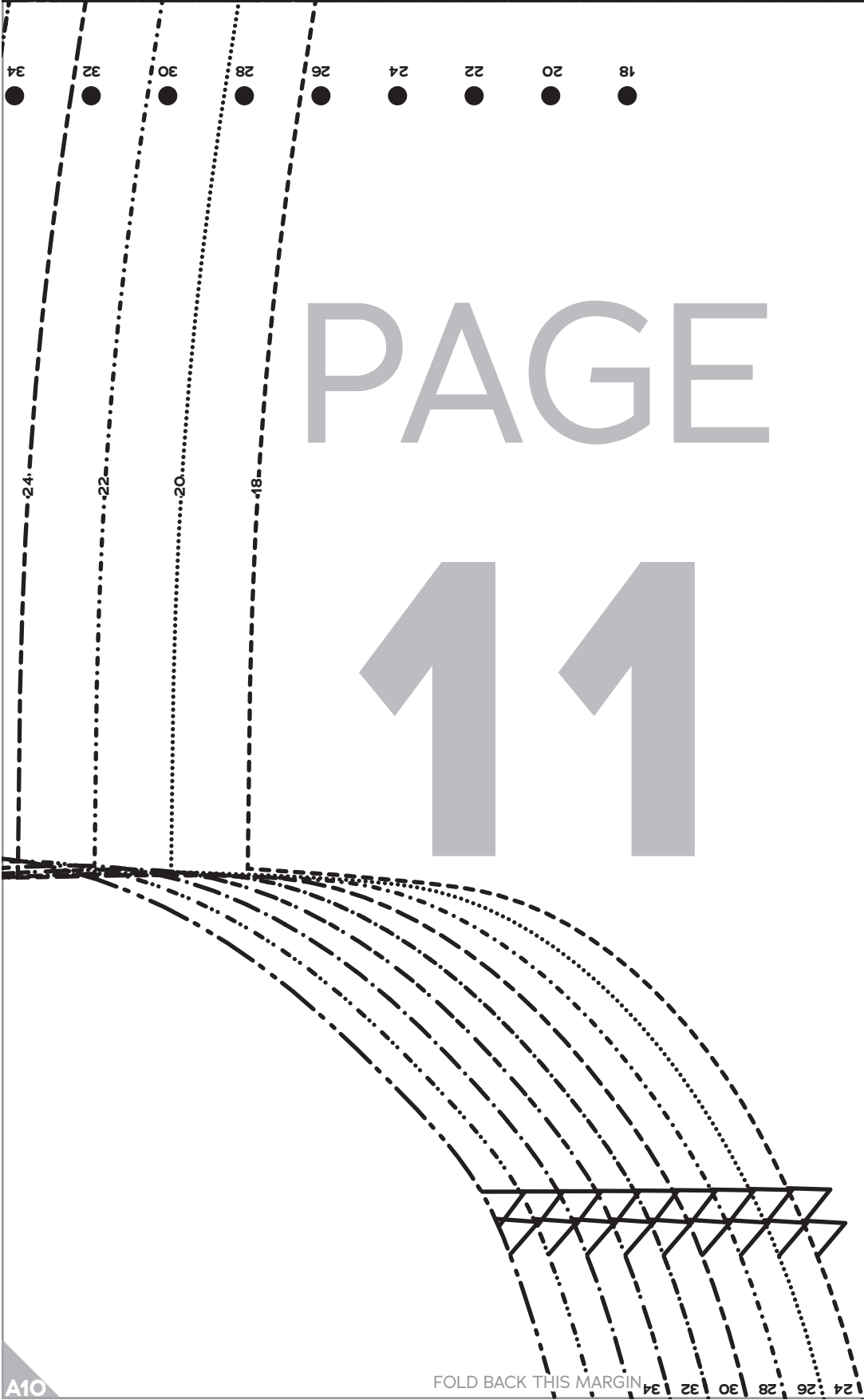

A10

FOLD BACK THIS MARGIN

A11

GATHER BE

182022242628303234
●●●●●●●●●●●●●●●●

PAGE

12

Bodice Back
Cut 1 fabric on fold

2

SIZES 18-34

DRESS

Society

Society of CHARM



FOLD

A11

FOLD BACK THIS MARGIN

A1

Society of CHARM
 Society
 DRESS
 SIZES 18-34
 8
 Front Neck Facing
 Cut 2 fabric,
 2 interfacing

PAGE 13

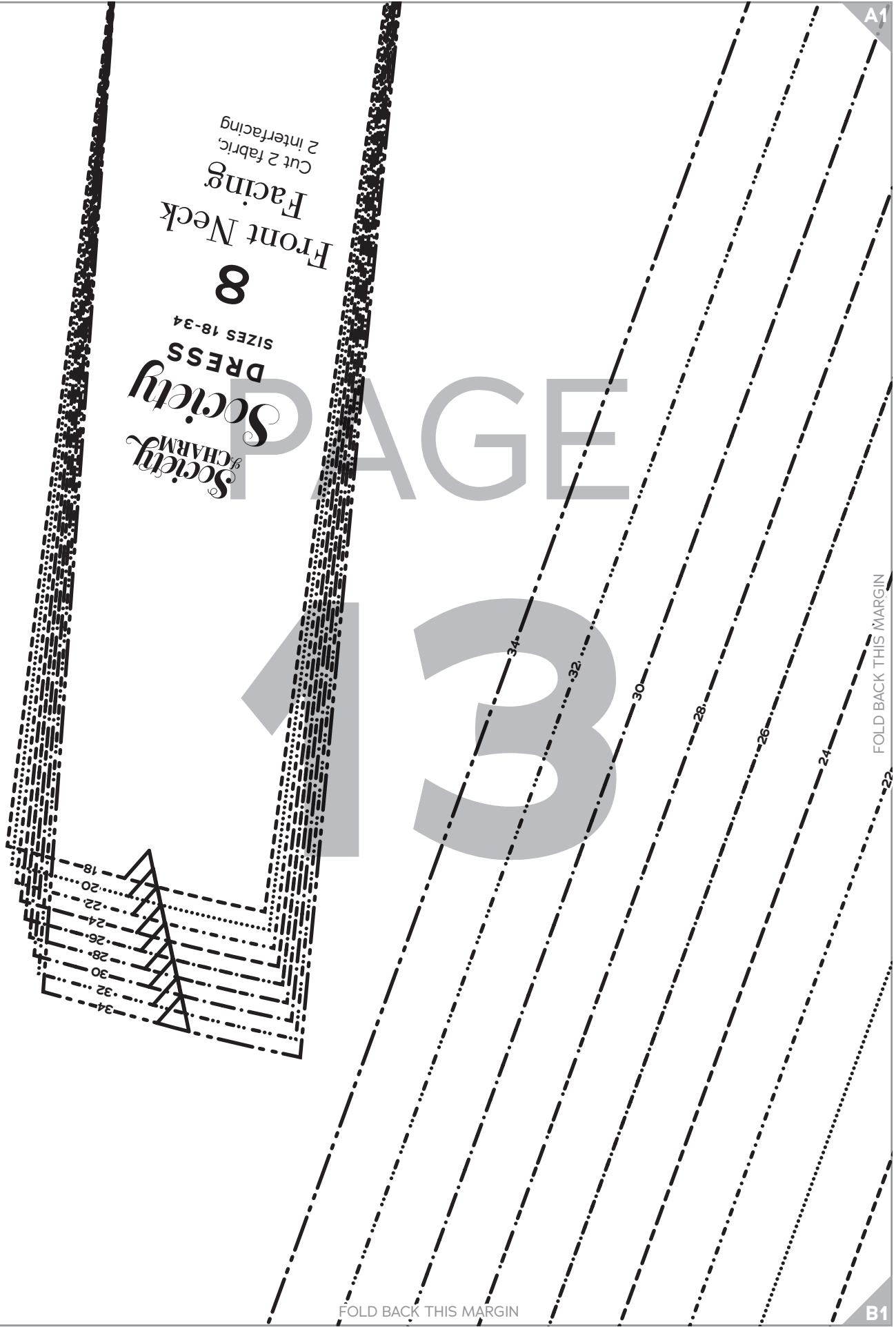

FOLD BACK THIS MARGIN

FOLD BACK THIS MARGIN

B1

A1

A2

PAGE

14

FOLD BACK THIS MARGIN

B1

FOLD BACK THIS MARGIN

B2

PAGE

15

Society
of CHARM

Society
DRESS
SIZES 18-34

10
Knee-Length
Skirt Front
Cut 1 fabric on fold

FOLD BACK THIS MARGIN

A3

A4

PAGE 16

FOLD

FOLD BACK THIS MARGIN

B3

FOLD BACK THIS MARGIN

B4

A4

A5

PAGE

17

FOLD BACK THIS MARGIN

B4

FOLD BACK THIS MARGIN

B5

A5

A6

PAGE

18

FOLD BACK THIS MARGIN

B5

FOLD BACK THIS MARGIN

B6

A6

A7

Cut 1 fabric on fold
 Knee-Length
 Skirt Back
 ↓ ↓
 Society of Charm
 Dress
 Sizes 18-34

PAGE

19

FOLD BACK THIS MARGIN

B6

FOLD BACK THIS MARGIN

B7

A7

A8

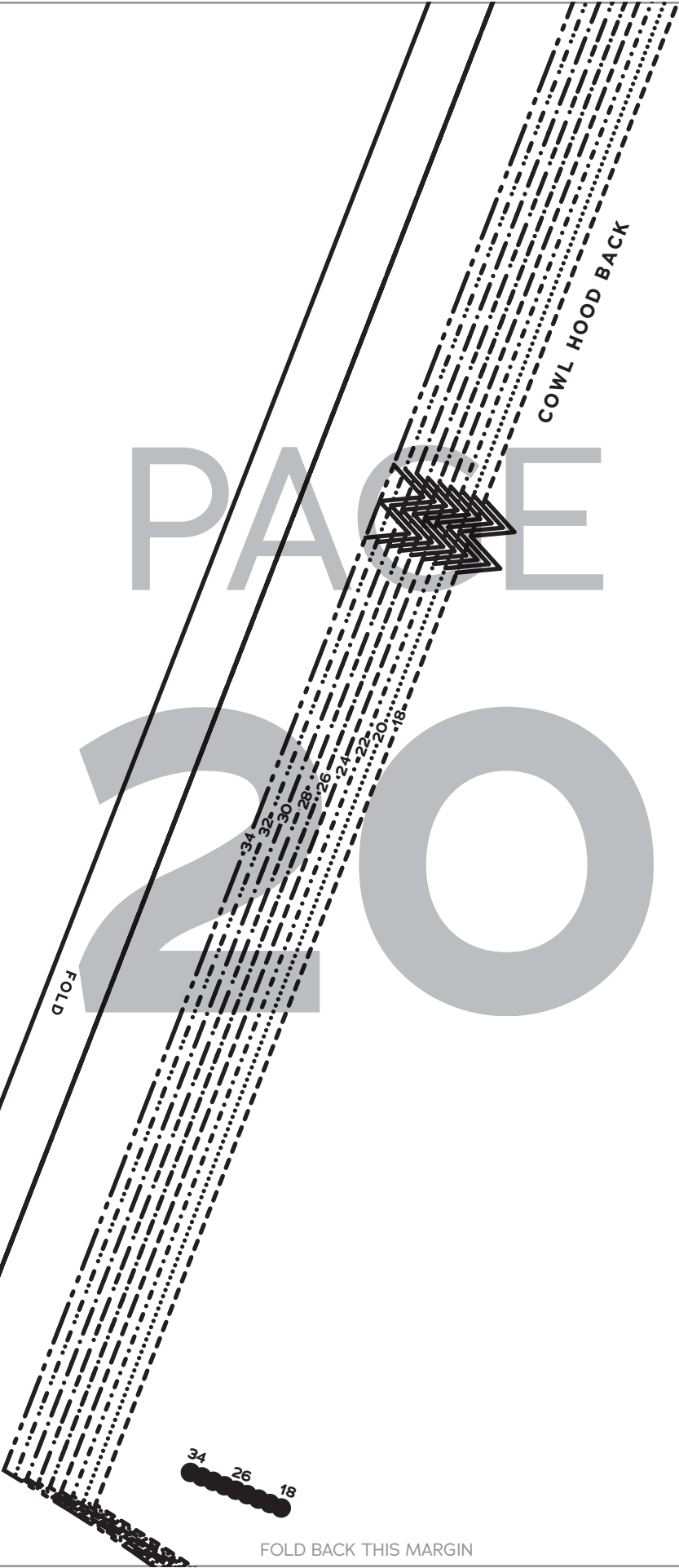

FOLD

COWL HOOD BACK

PAGE 20

34 26 18

FOLD BACK THIS MARGIN

FOLD BACK THIS MARGIN

B7

B8

A8

A9

PAGE

21

FOLD BACK THIS MARGIN

GRAINLINE

15
HOOD
COWL
DRESS
SIZES 18-34
Society of Charm

B8

FOLD BACK THIS MARGIN

B9

A9

A10

PAGE

22

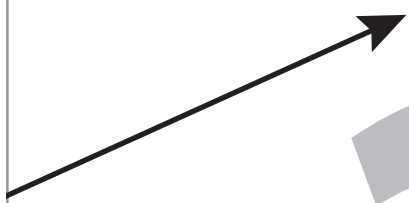

FOLD BACK THIS MARGIN

B9

FOLD BACK THIS MARGIN

B10

A10

A11

PAGE
23

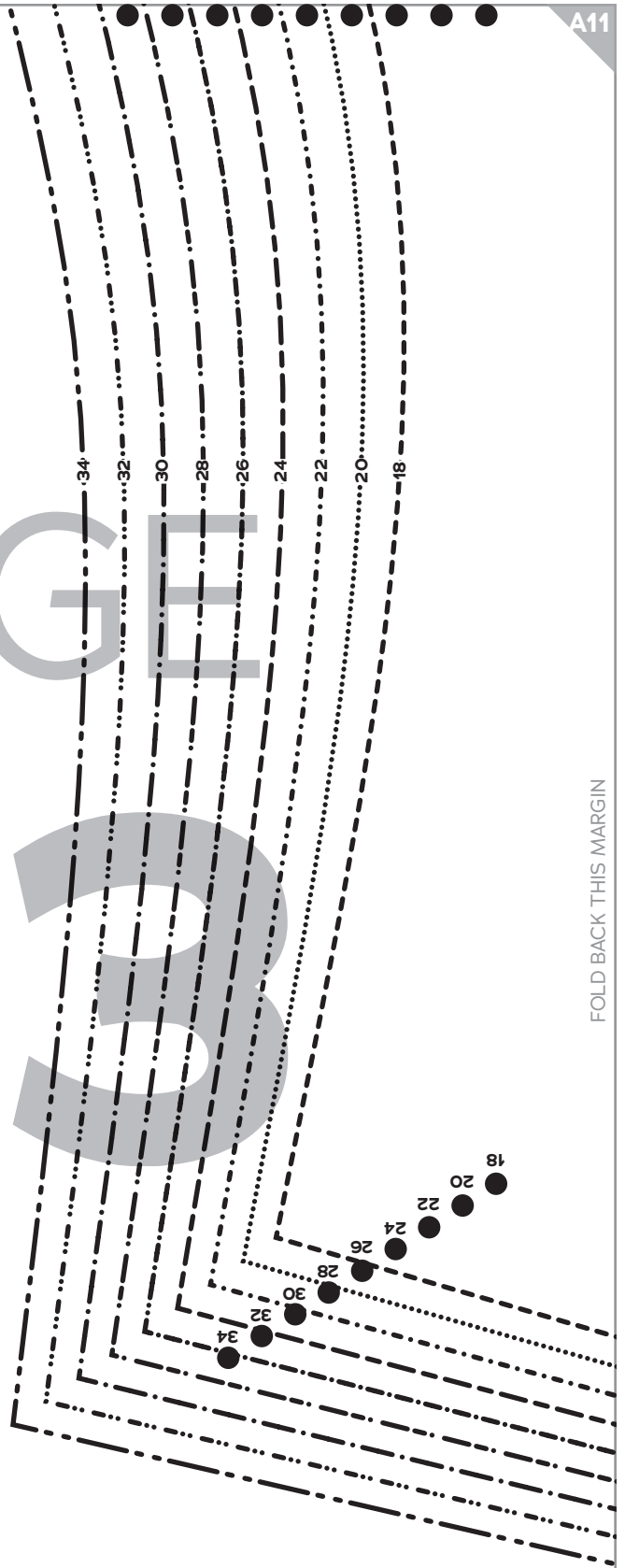

FOLD BACK THIS MARGIN

FOLD BACK THIS MARGIN

B10

B11

PAGE

24

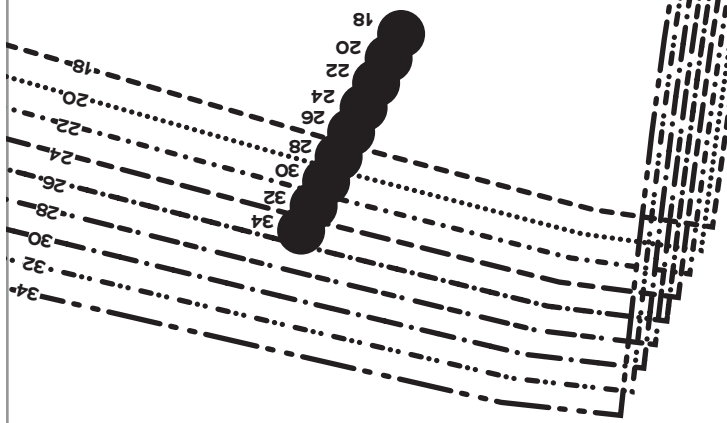

B1

PAGE

25

FOLD BACK THIS MARGIN

FOLD BACK THIS MARGIN

C1

B1

B2

PAGE 26

FOLD BACK THIS MARGIN

C1

FOLD BACK THIS MARGIN

C2

B2

B3

PAGE

27

FOLD BACK THIS MARGIN

C2

FOLD BACK THIS MARGIN

C3

B3

B4

PAGE 28

FOLD BACK THIS MARGIN

C3

FOLD BACK THIS MARGIN

C4

B4

B5

PAGE
29

FOLD BACK THIS MARGIN

C4

FOLD BACK THIS MARGIN

C5

B5

B6

PAGE

30

FOLD BACK THIS MARGIN

C5

FOLD BACK THIS MARGIN

C6

B6

B7

PAGE

31

FOLD BACK THIS MARGIN

C6

FOLD BACK THIS MARGIN

C7

PAGE 32

FOLD

Society of CHARM
DRESS
SIZES 18-34

9
Back Neck Facing
Cut 1 fabric on fold,
1 interfacing on fold

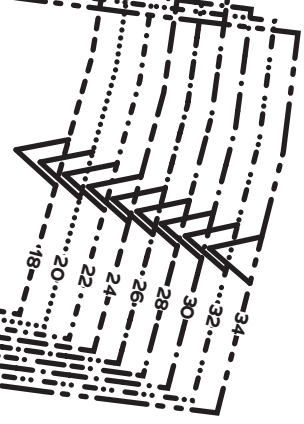

FOLD BACK THIS MARGIN

FOLD BACK THIS MARGIN

B8

B9

PAGE

33

FOLD BACK THIS MARGIN

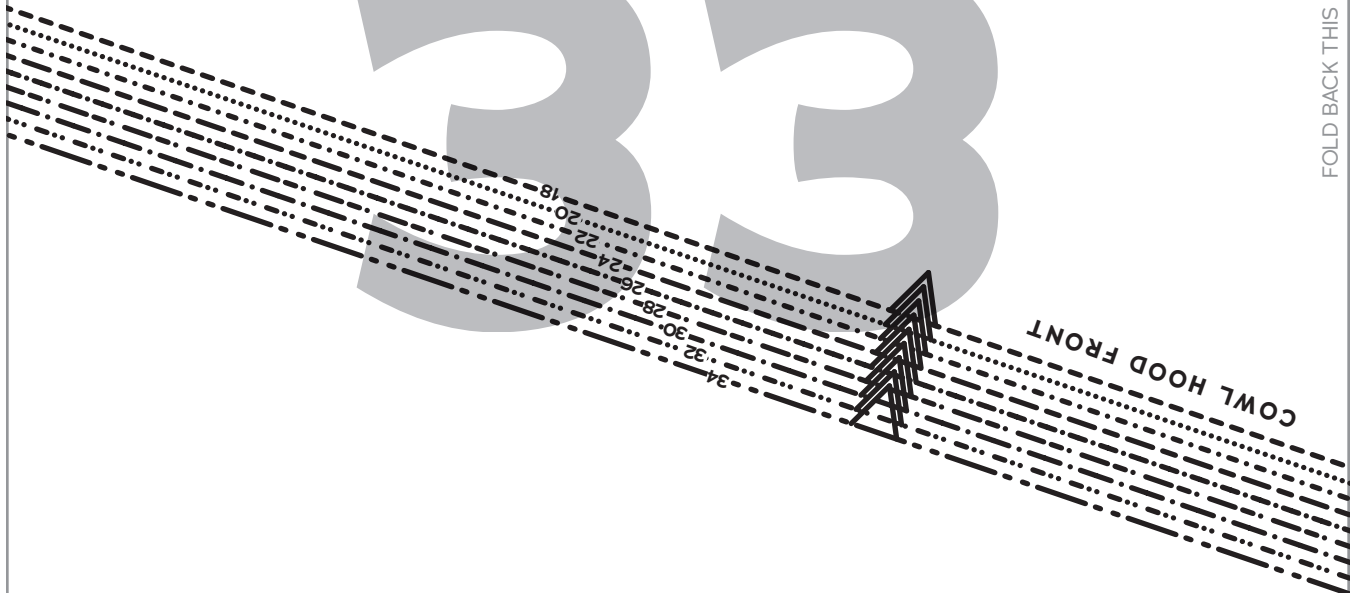

C8

FOLD BACK THIS MARGIN

C9

B9

B10

PAGE

34

FOLD BACK THIS MARGIN

C9

FOLD BACK THIS MARGIN

C10



PAGE 35

Society
 & CHARM
Society
DRESS
 SIZES 18-34

FOLD BACK THIS MARGIN

B11

6
 Bishop
 Sleeve Cuff
 Cut 2 fabric

PAGE
 36

FOLD LINE

GRAINLINE

18 20 22 24 26 28 30 32 34

18 20 22 24 26 28 30 32 34

C11

FOLD BACK THIS MARGIN

PAGE

37

FOLD BACK THIS MARGIN

FOLD BACK THIS MARGIN

C1

C2

PAGE

38

FOLD BACK THIS MARGIN

D1

FOLD BACK THIS MARGIN

D2

C2

C3

20
18

PAGE

39

FOLD BACK THIS MARGIN

D2

FOLD BACK THIS MARGIN

D3

C3

C4

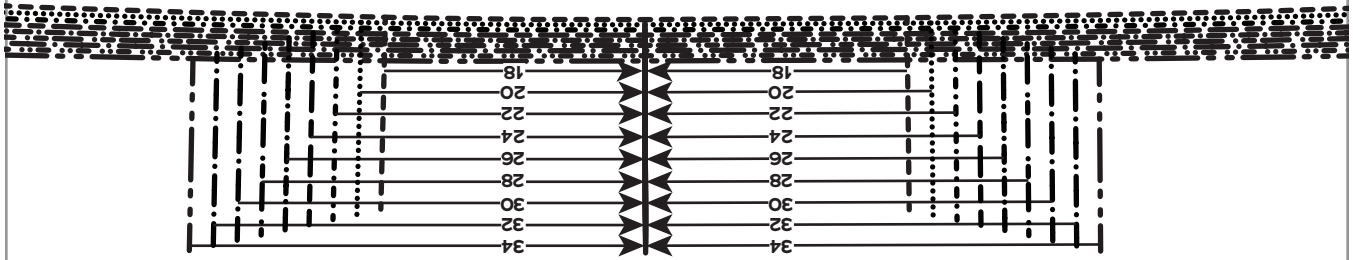

PLEAT

PAGE

40

Cut 2 fabric
 Sleeve
 Short Pleated

7

SIZES 18-34

DRESS

Society

Society
of CHARM

GRAINLINE

FOLD BACK THIS MARGIN

D3

FOLD BACK THIS MARGIN

D4

C4

C5

PAGE 41

FOLD BACK THIS MARGIN

18 ●
 20 ●
 22 ●
 24 ●
 26 ●
 28 ●

FOLD BACK THIS MARGIN

D4

D5

C5

C6

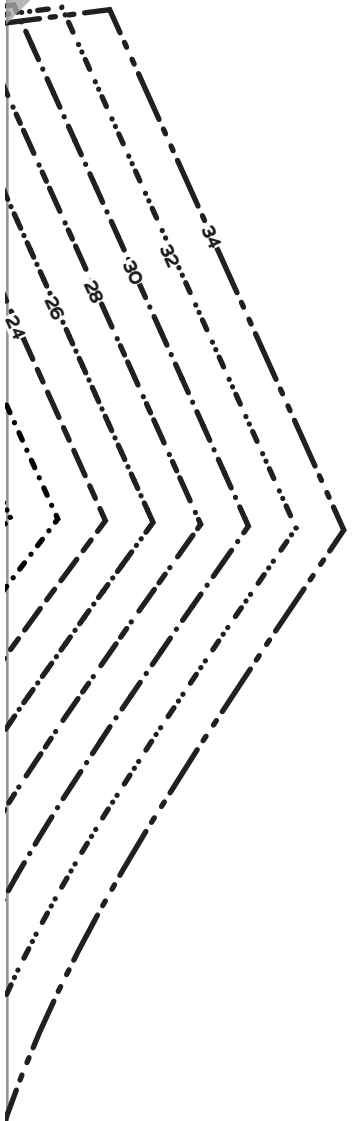

PAGE

42

FOLD BACK THIS MARGIN

D5

FOLD BACK THIS MARGIN

D6

C6

C7

PAGE

43

FOLD BACK THIS MARGIN

D6

FOLD BACK THIS MARGIN

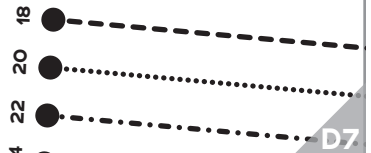

D7

C7

C8

PAGE

44

FOLD BACK THIS MARGIN

D7

FOLD BACK THIS MARGIN

D8

C8

C9

FOLD

PAGE

45

Society
of
CHARM

Society

DRESS

SIZES 18-34

12

Floor-Length

Skirt Front

Cut 1 fabric on fold

FOLD BACK THIS MARGIN

D8

FOLD BACK THIS MARGIN

D9

C9

C10

PAGE

46

FOLD BACK THIS MARGIN

D9

FOLD BACK THIS MARGIN

D10

C10

C11

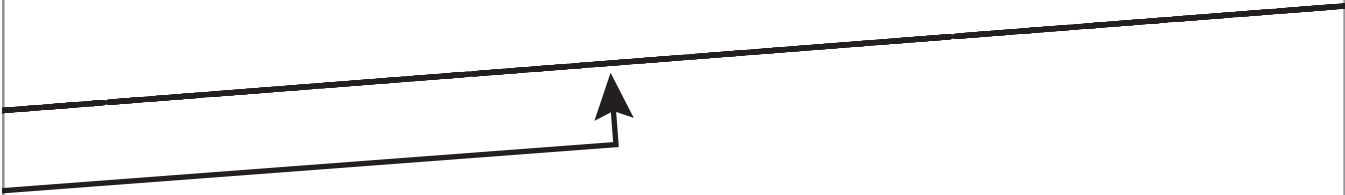

PAGE

47

FOLD BACK THIS MARGIN

D10

FOLD BACK THIS MARGIN

D11

PAGE

48

D1

GRAINLINE

PAGE 49

FOLD BACK THIS MARGIN

FOLD BACK THIS MARGIN

E1

D1

D2

PAGE

50

FOLD BACK THIS MARGIN

E1

FOLD BACK THIS MARGIN

E2

D2

D3

32
34

PAGE

51

FOLD BACK THIS MARGIN

34

32

30

28

26

24

22

20

18

E2

FOLD BACK THIS MARGIN

E3

D3

D4



PAGE

EAM

52

FOLD BACK THIS MARGIN

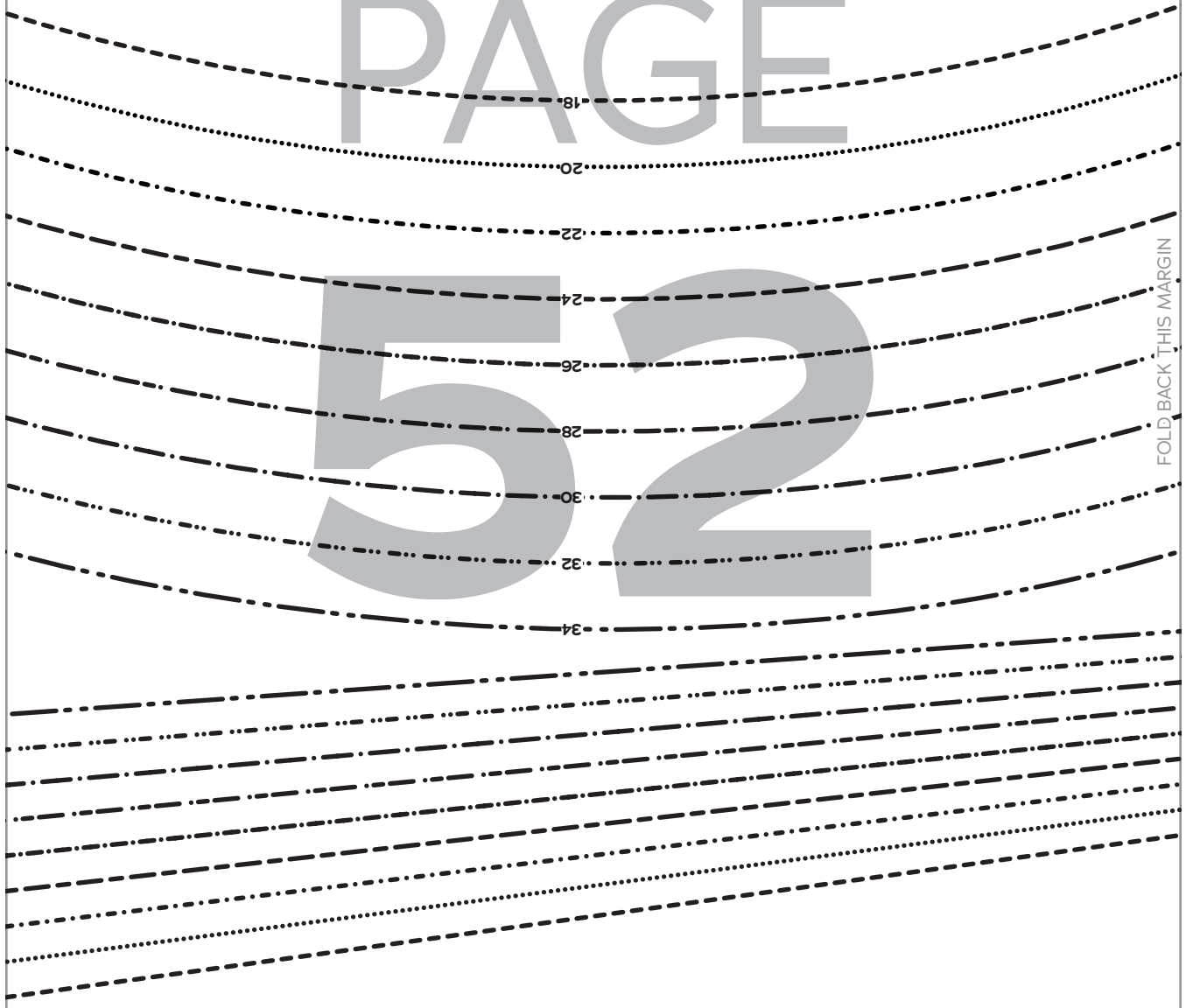

E3

FOLD BACK THIS MARGIN

E4

D4

D5

ALIGN NOTCH TO SHOULDERS

PAGE

53

FOLD BACK THIS MARGIN

18 20 22 24 26 28 30 32 34

E4

FOLD BACK THIS MARGIN

E5

D5

D6

PAGE

54

FOLD BACK THIS MARGIN

22

24

26

28

30

32

34

E5

FOLD BACK THIS MARGIN

E6

D6

D7

GODE

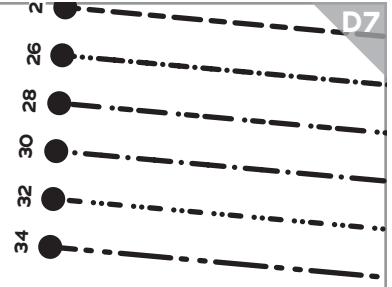

PAGE

55

FOLD BACK THIS MARGIN

SIDE SEAM
GODET

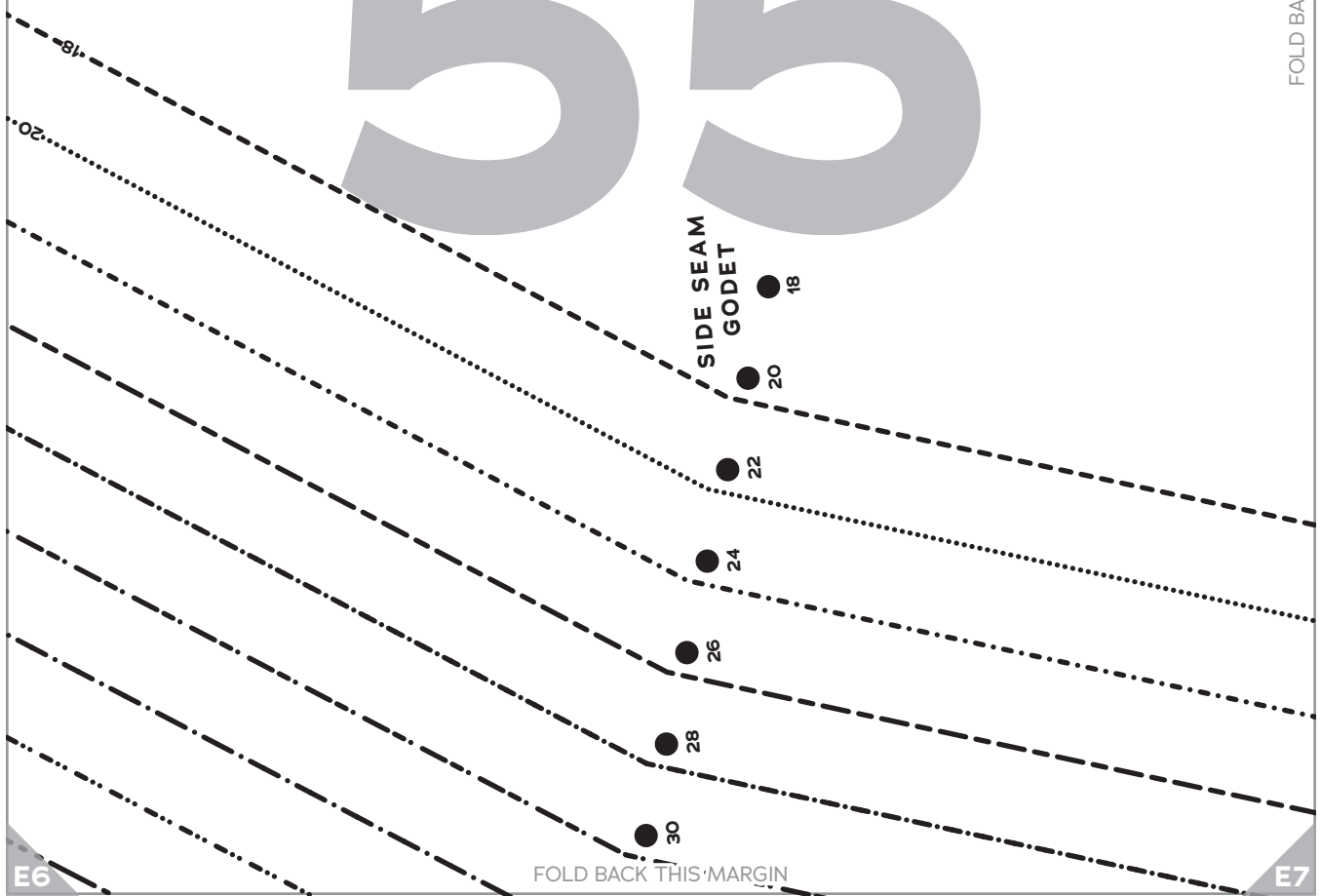

FOLD BACK THIS MARGIN

E6

E7

D7

D8

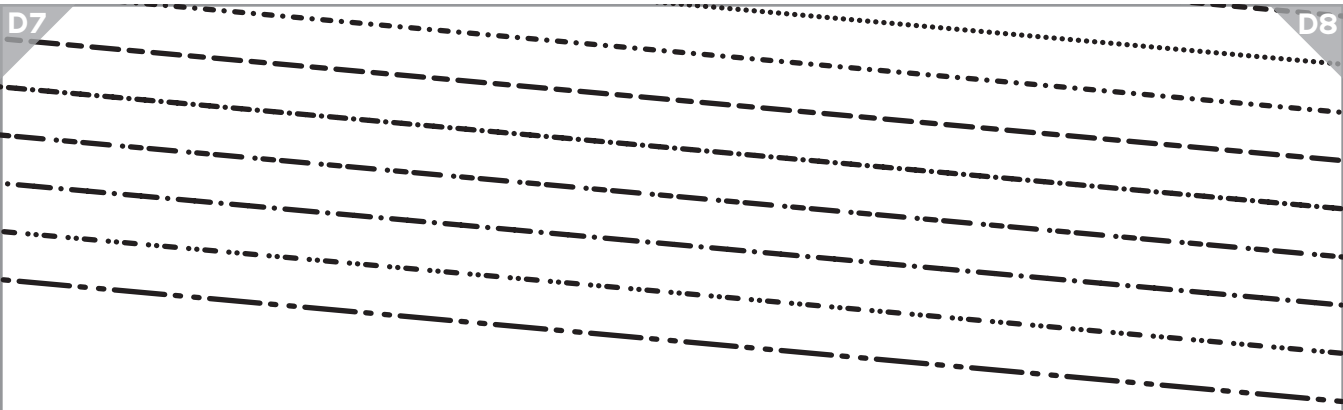

PAGE

56

FOLD BACK THIS MARGIN

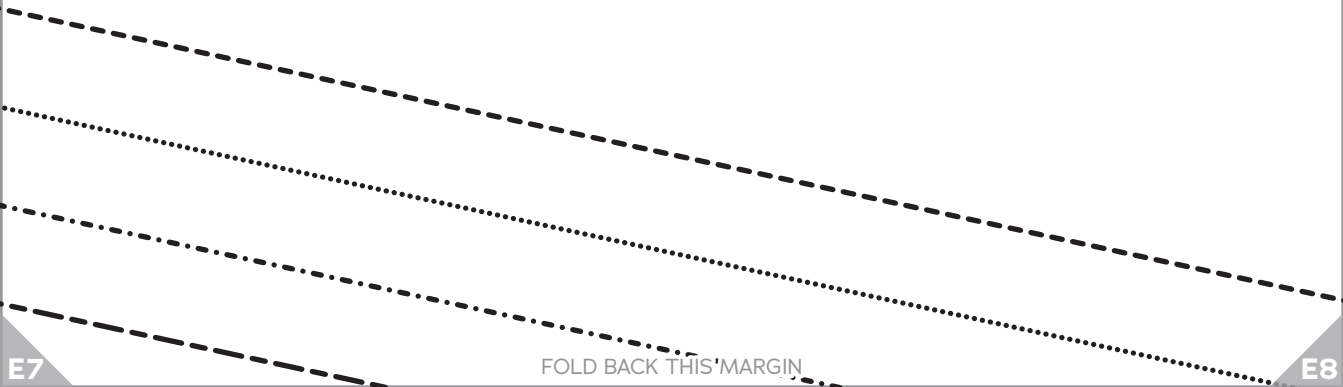

E7

FOLD BACK THIS MARGIN

E8

D8

D9

GO

PAGE

57

FOLD BACK THIS MARGIN

E8

FOLD BACK THIS MARGIN

E9

D9

D10

NET CUTTING LINE

PAGE

58

FOLD BACK THIS MARGIN

E9

FOLD BACK THIS MARGIN

E10

D10

D11

PAGE

59

FOLD BACK THIS MARGIN

E10

FOLD BACK THIS MARGIN

E11

D11

PAGE

60

E11

FOLD BACK THIS MARGIN

Floor-Length
Skirt Godet
Cut 6 fabric

14

SIZES 18-34

Society
DRESS

Society
of CHARM

PAGE

61

FOLD BACK THIS MARGIN

FOLD BACK THIS MARGIN

E1

E2

PAGE

62

ALIGN NOTCH TO SHOULDER SEAM

FOLD BACK THIS MARGIN

34

32

30

28

26

24

22

20

18

F1

FOLD BACK THIS MARGIN

F2



E2

E3

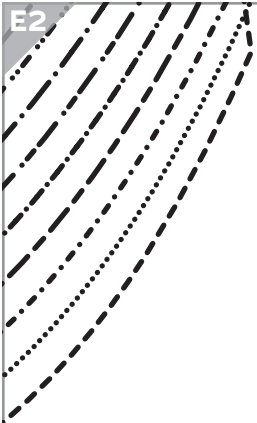

PAGE

63

FOLD BACK THIS MARGIN

GRAINLINE

F2

FOLD BACK THIS MARGIN

F3

E3

E4

PAGE

64

FOLD BACK THIS MARGIN

Society
of CHARM
Society

DRESS
SIZES 18-34

5

**Bishop
Sleeve**
Cut 2 fabric

F3

FOLD BACK THIS MARGIN

F4

E4

E5

PAGE 65

FOLD BACK THIS MARGIN

GATHER BETWEEN CIRCLES



FOLD BACK THIS MARGIN

F4

F5

E5

E6

PAGE
66

FOLD BACK THIS MARGIN

F5

FOLD BACK THIS MARGIN

F6

E6

E7

32

34

PAGE

67

FOLD BACK THIS MARGIN

F6

FOLD BACK THIS MARGIN

F7

E7

E8

PAGE

68

FOLD BACK THIS MARGIN



F7

FOLD BACK THIS MARGIN

F8

E8

E9

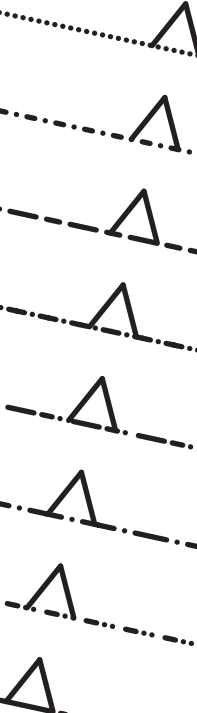

PAGE

69

FOLD BACK THIS MARGIN

FOLD

F8

FOLD BACK THIS MARGIN

F9

E9

E10

18

20

22

24

26

28

30

32

34

PAGE

70

FOLD BACK THIS MARGIN

F9

FOLD BACK THIS MARGIN

F10

E10

E11

PAGE

71

FOLD BACK THIS MARGIN

F10

FOLD BACK THIS MARGIN

F11

PAGE

72

PAGE

73

FOLD BACK THIS MARGIN

FOLD BACK THIS MARGIN

F1

F2

PAGE

74

FOLD BACK THIS MARGIN

G1

FOLD BACK THIS MARGIN

G2

F2

F3

PAGE

75

FOLD BACK THIS MARGIN

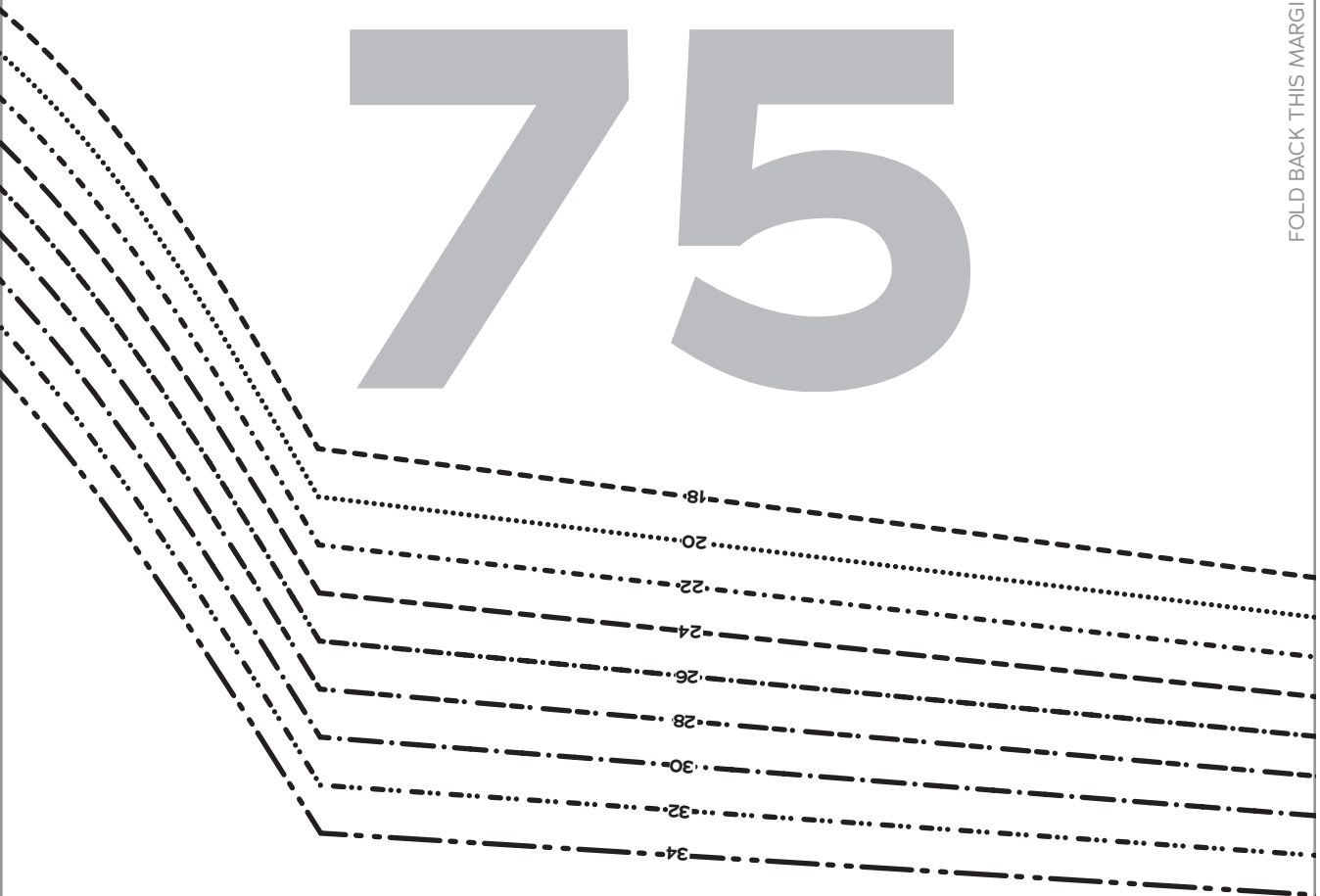

G2

FOLD BACK THIS MARGIN

G3

F3

F4

PAGE

76

FOLD BACK THIS MARGIN

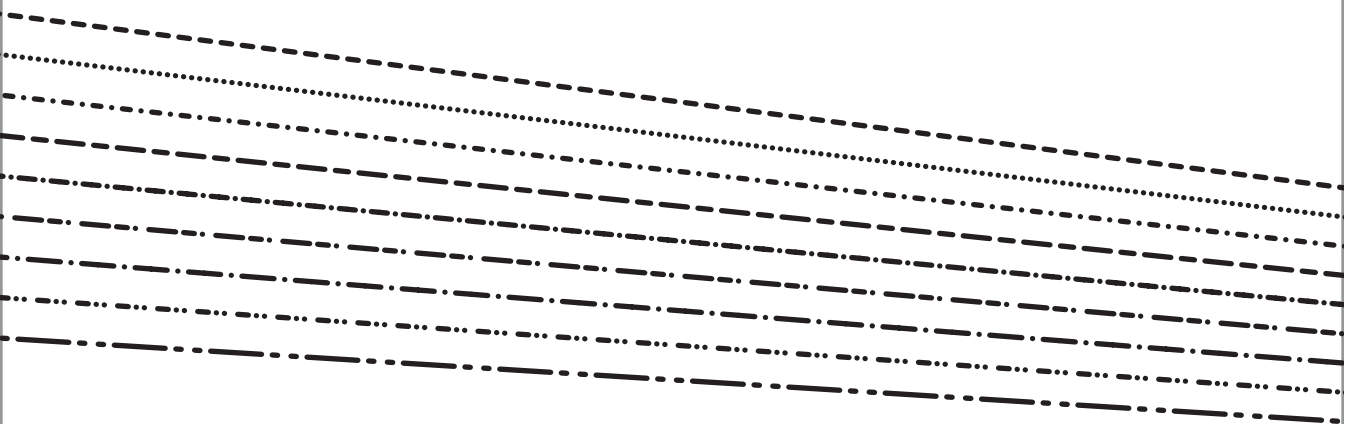

G3

FOLD BACK THIS MARGIN

G4

F4

F5

PAGE

77

FOLD BACK THIS MARGIN

843250282624222018

G4

FOLD BACK THIS MARGIN

G5

F5

F6

PAGE

78

FOLD BACK THIS MARGIN

G5

FOLD BACK THIS MARGIN

G6

F6

F7

PAGE

79

FOLD BACK THIS MARGIN

G6

FOLD BACK THIS MARGIN

G7

F7

F8

PAGE

80

GODET CUTTING

FOLD BACK THIS MARGIN

G7

FOLD BACK THIS MARGIN

G8

F8

F9

Floor-Length
Skirt Back
Cut 1 fabric on fold

13

Society
of
CHARM
DRESS
SIZES 18-34

PAGE

81

FOLD BACK THIS MARGIN

CUT LINE

G8

FOLD BACK THIS MARGIN

G9

F9

F10

PAGE

82

FOLD BACK THIS MARGIN

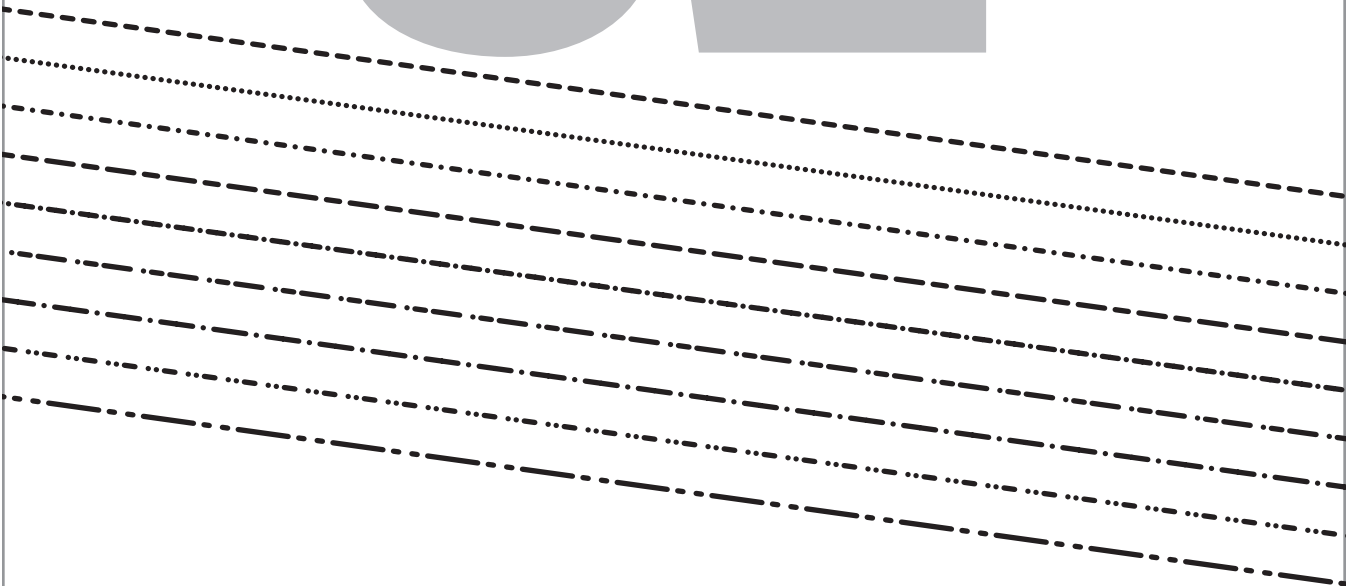

G9

FOLD BACK THIS MARGIN

G10

F10

F11



PAGE

83

FOLD BACK THIS MARGIN

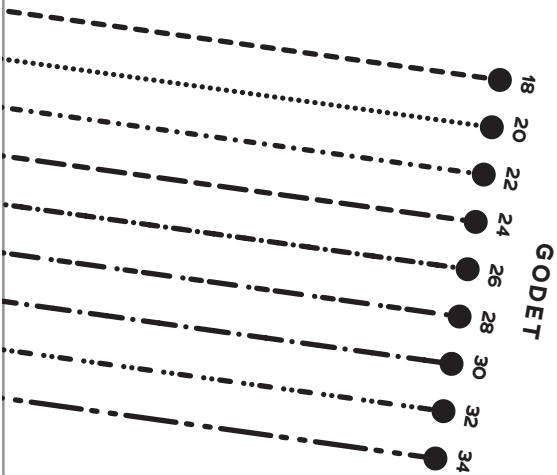

G10

FOLD BACK THIS MARGIN

G11

PAGE

84

PAGE

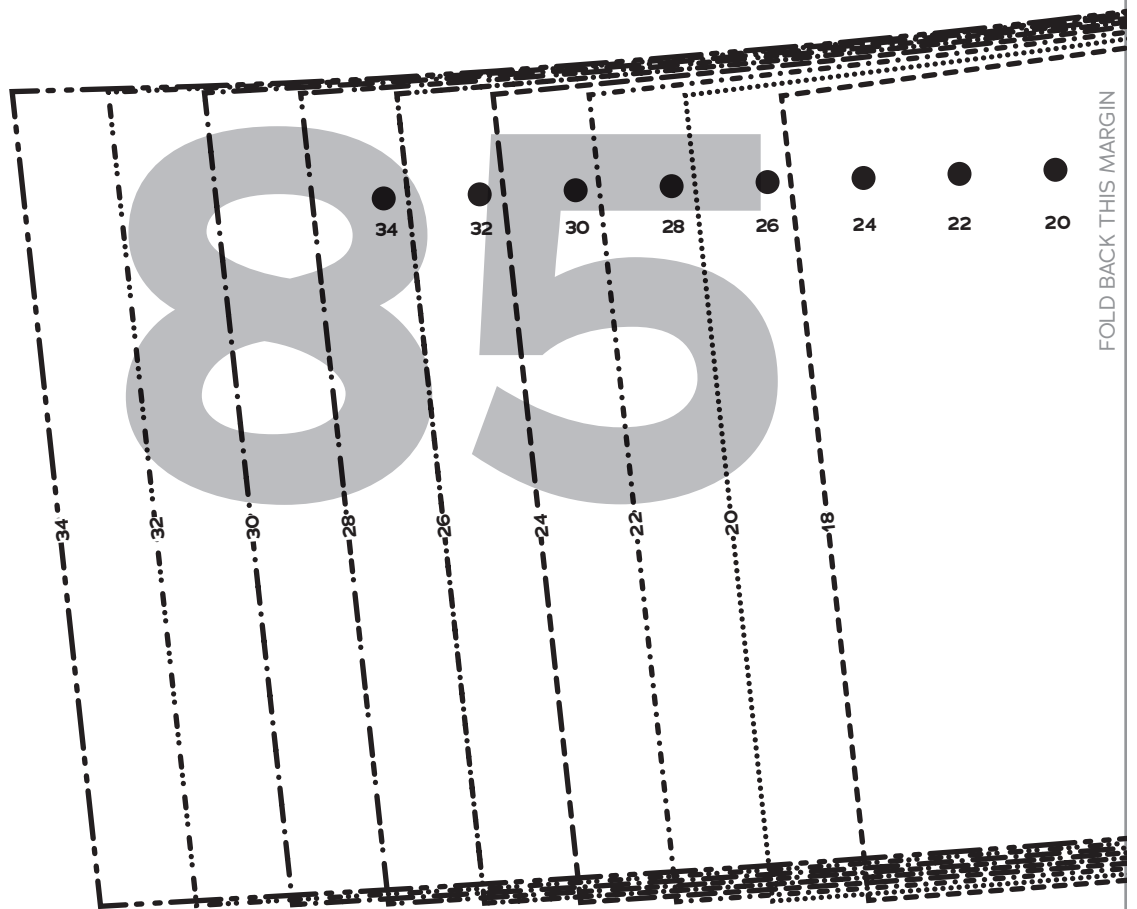

FOLD BACK THIS MARGIN

G1

G2

PAGE

●
18

86

Society
of CHARM
Society
DRESS
SIZES 18-34

3
Midriff
Front

Cut 1 fabric on fold,
1 power mesh on fold

FOLD BACK THIS MARGIN

H1

FOLD BACK THIS MARGIN

H2

G2

G3

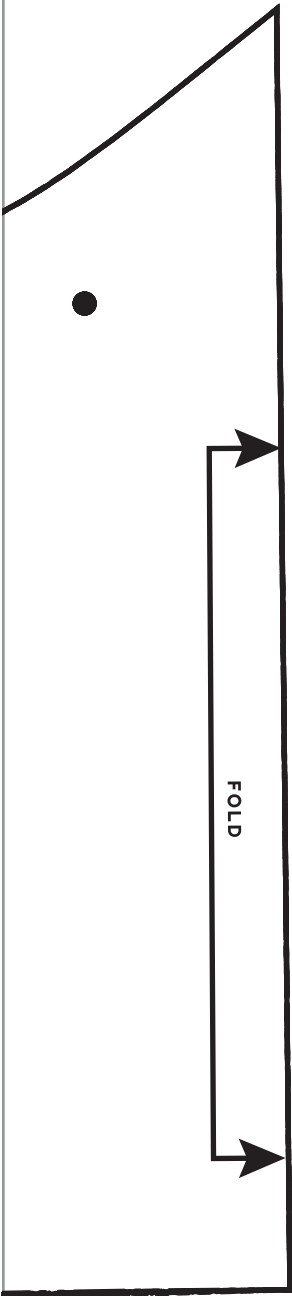

PAGE

87

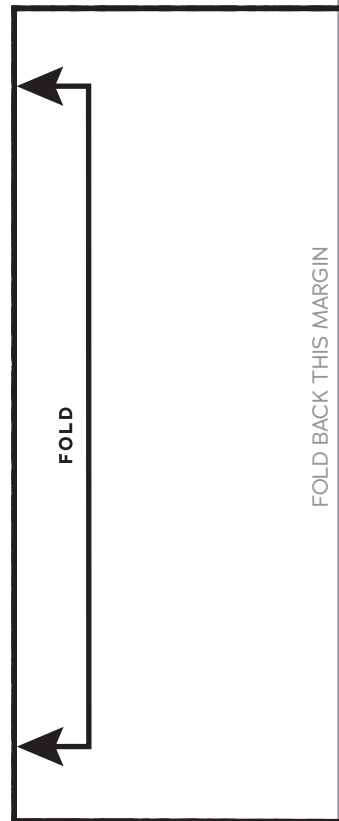

FOLD BACK THIS MARGIN

H2

FOLD BACK THIS MARGIN

H3

G3

G4

PAGE

●●●●●●●●●●
18 20 22 24 26 28 30 32 34

●
18

●
20

Society
of CHARM
Society
DRESS
SIZES 18-34

4
Midriff
Back
Cut 1 fabric on fold

FOLD BACK THIS MARGIN

H3

FOLD BACK THIS MARGIN

H4

G4

G5

PAGE 89

●
22

●
24

●
26

●
28

●
30

●
32

●
34

18

20

22

24

26

28

30

32

34

FOLD BACK THIS MARGIN

H4

FOLD BACK THIS MARGIN

H5

G5

G6

PAGE

90

FOLD BACK THIS MARGIN

H5

FOLD BACK THIS MARGIN

H6

G6

G7

PAGE

91

FOLD BACK THIS MARGIN

H6

FOLD BACK THIS MARGIN

H7

G7

G8

PAGE

92

FOLD BACK THIS MARGIN

18

20

22

24

26

28

30

32

34

FOLD BACK THIS MARGIN

H7

H8

G8

G9

PAGE

93

FOLD BACK THIS MARGIN

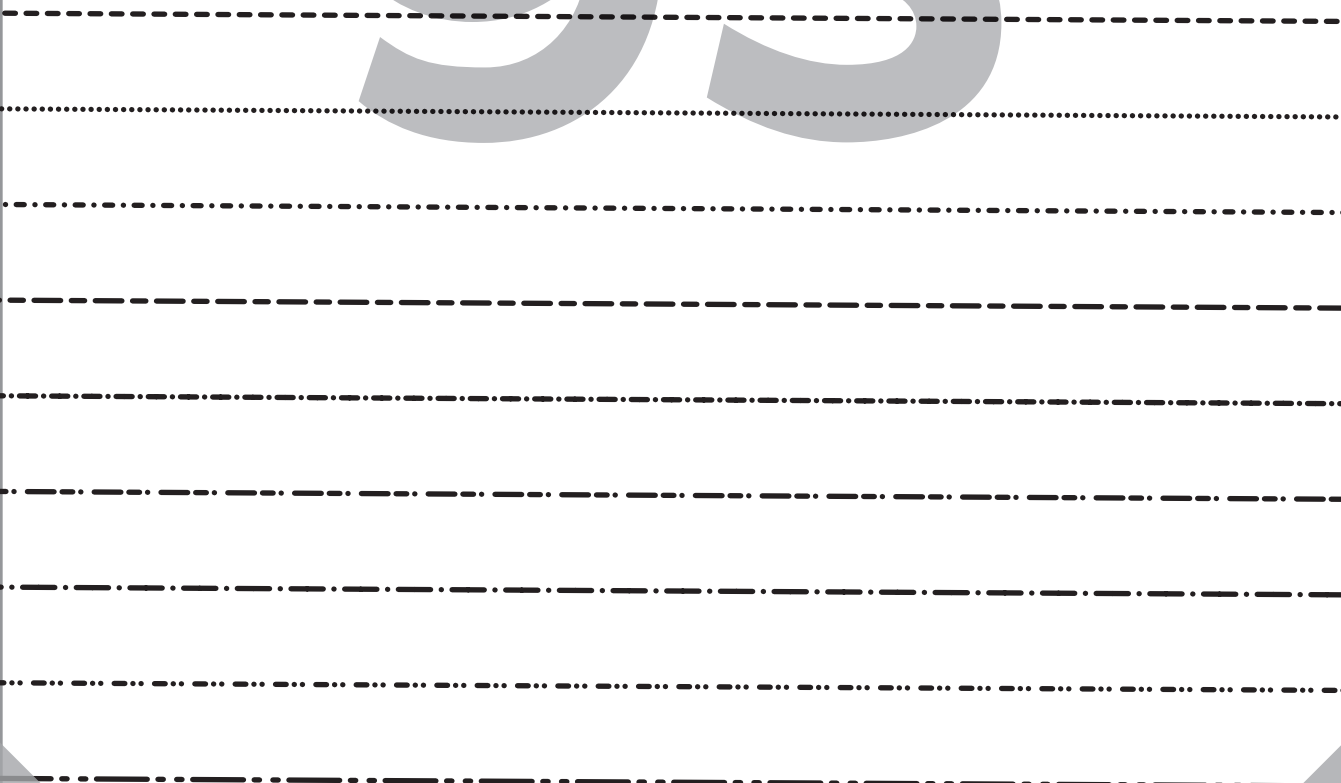

H8

FOLD BACK THIS MARGIN

H9

PAGE

94

FOLD BACK THIS MARGIN



PAGE

95

SIDE SEAM
GODET

18

20

22

24

26

28

30

32

34

FOLD BACK THIS MARGIN

FOLD BACK THIS MARGIN

PAGE

96

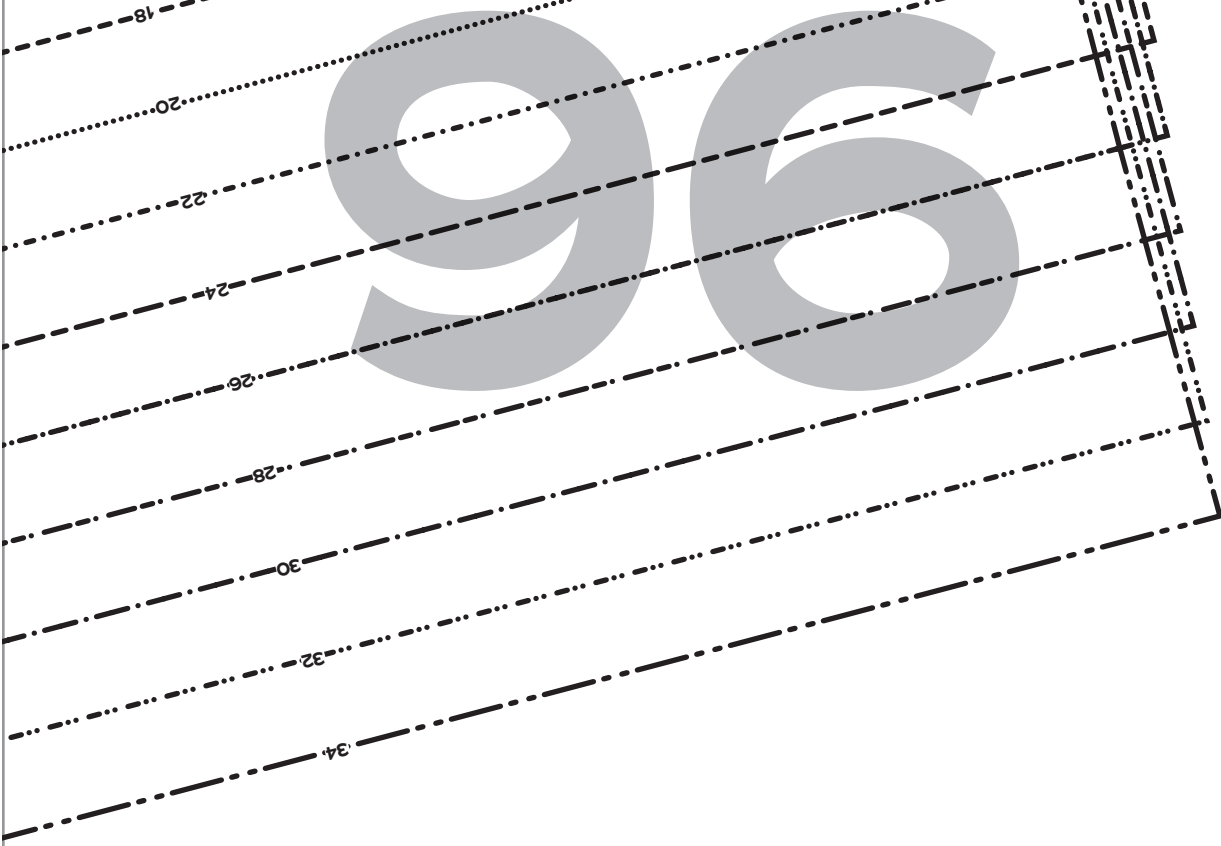

PAGE

97

18
26
34

Bodice Front,
H Cup
Cut 2 fabric



SIZES 18-34

DRESS

Society

Society
of CHARM

GRAINLINE

FOLD BACK THIS MARGIN

FOLD BACK THIS MARGIN

H1

H2

GATHER BETWEEN CIRCLES

PAGE

98

FOLD BACK THIS MARGIN

I1

FOLD BACK THIS MARGIN

I2

H2

H3

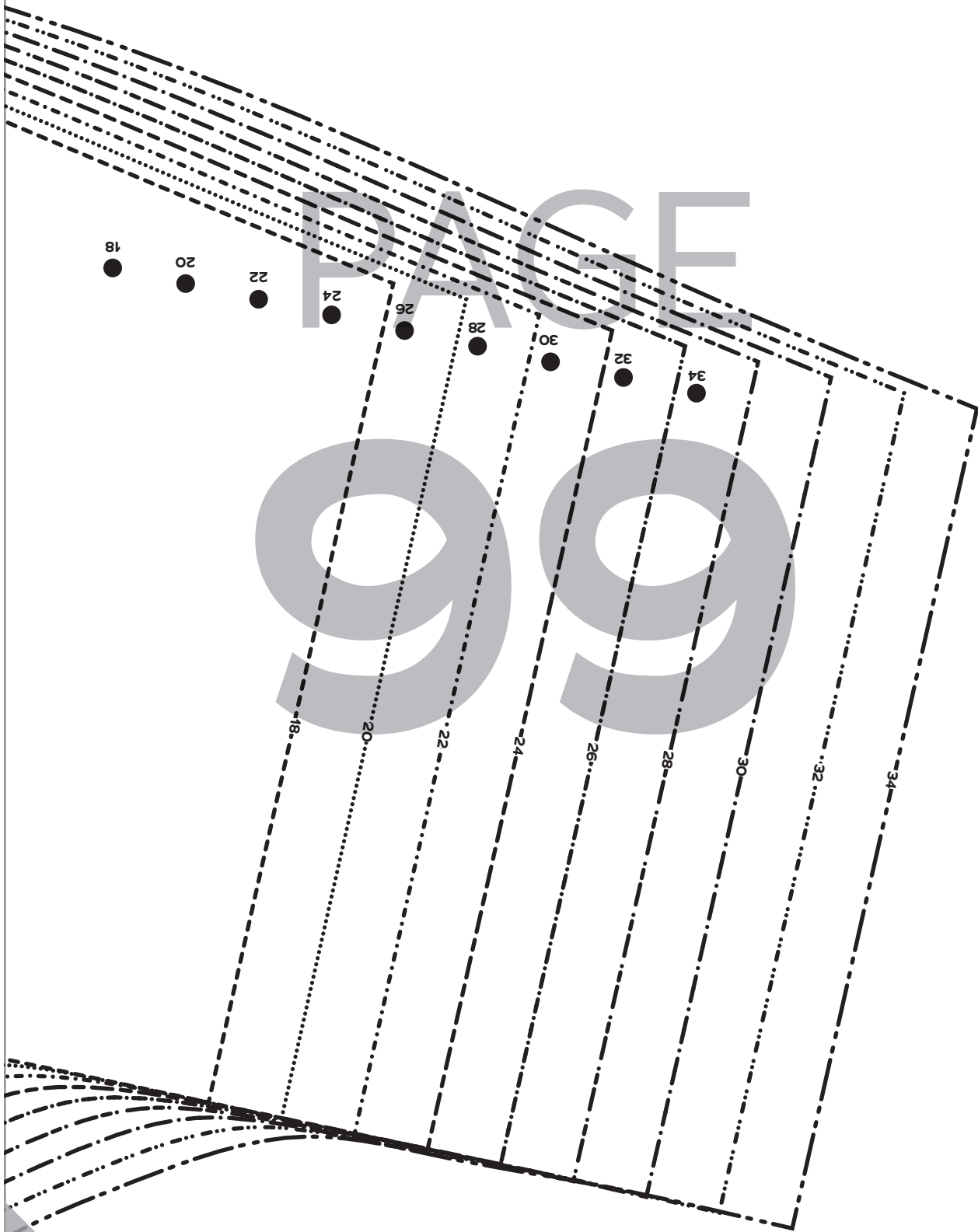

FOLD BACK THIS MARGIN

FOLD BACK THIS MARGIN

PAGE

100

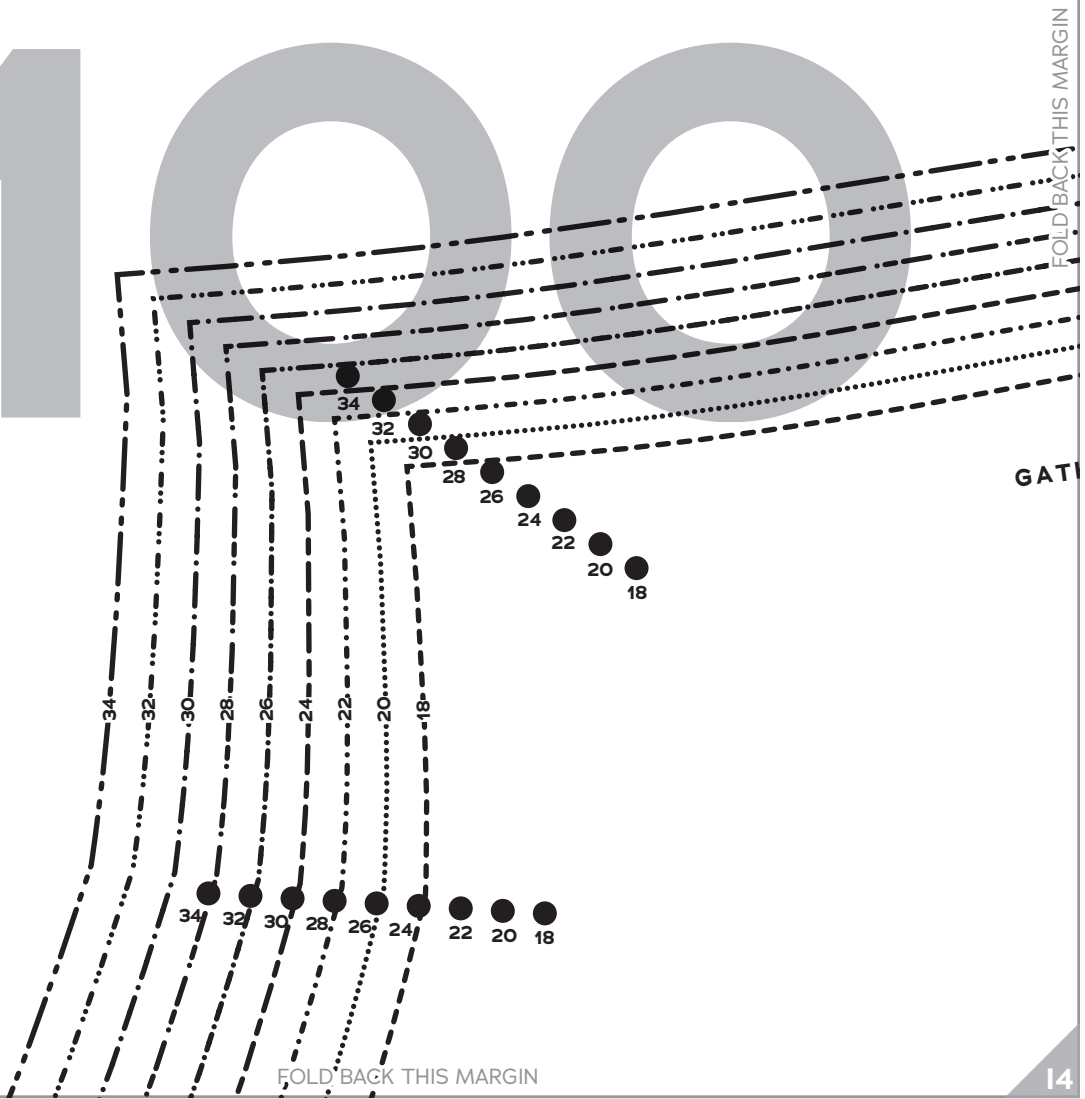

H4

H5

PAGE

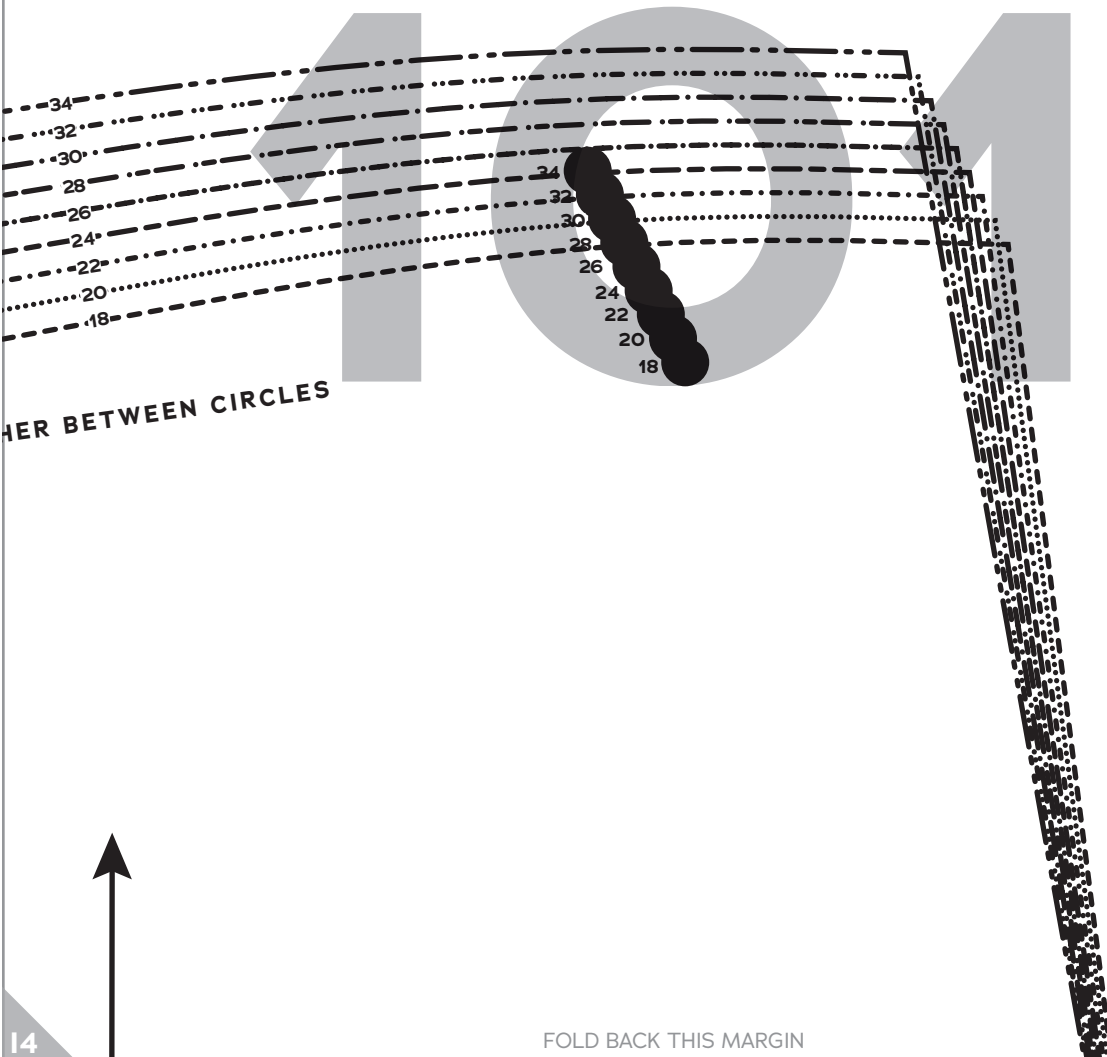

FOLD BACK THIS MARGIN

HER BETWEEN CIRCLES

I4

FOLD BACK THIS MARGIN

I5

H5

H6

PAGE

102

18
26
34

FOLD BACK THIS MARGIN

Bodice Front,
D/DD Cup
Cut 2 fabric



SIZES 18-34
DRESS
Society
of CHARM

GRAINLINE

I5

FOLD BACK THIS MARGIN

I6

H6

H7

GATHER BETWEEN CIRCLES

PAGE

18

20

103

FOLD BACK THIS MARGIN

I6

FOLD BACK THIS MARGIN

I7

H7

H8

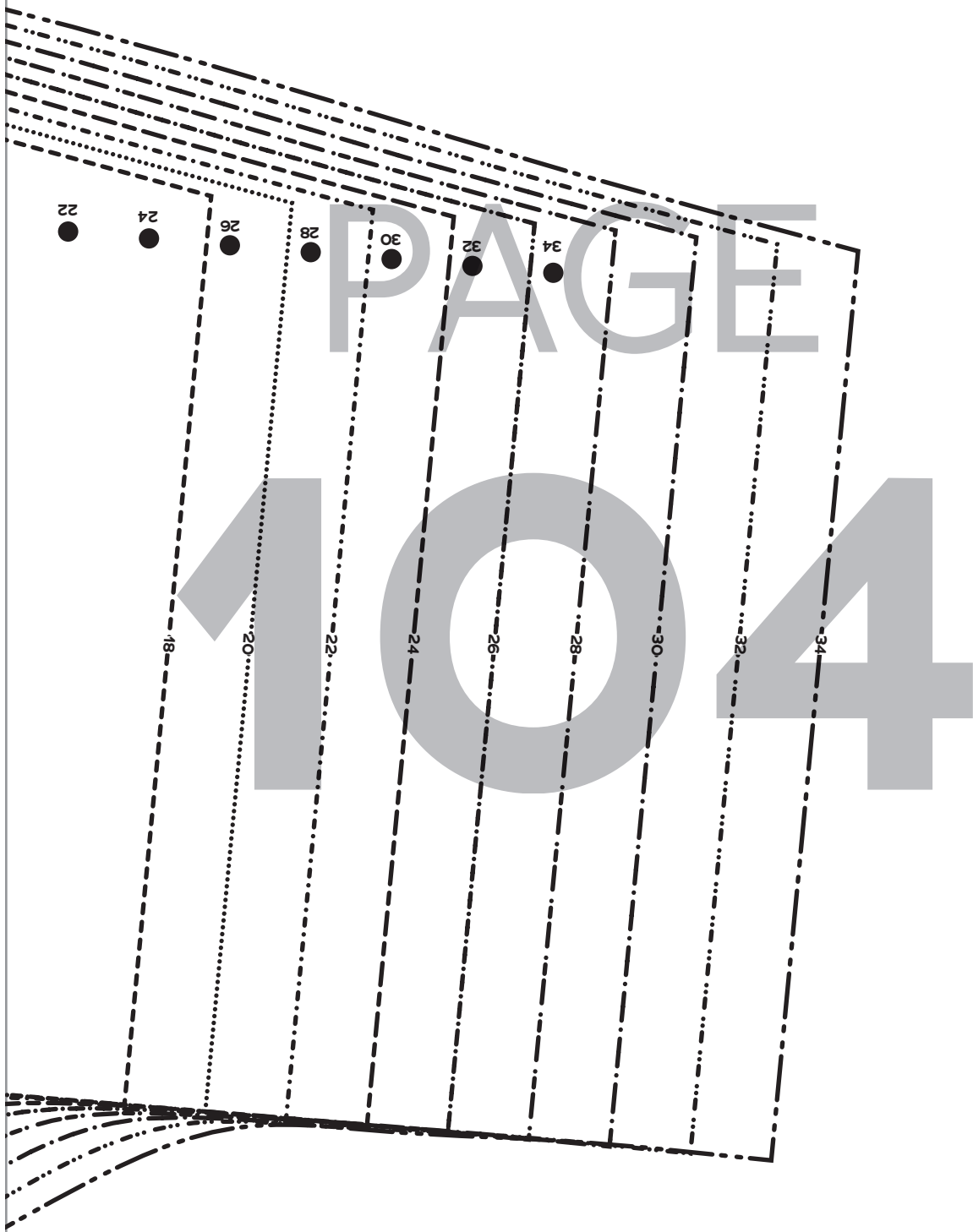

FOLD BACK THIS MARGIN

FOLD BACK THIS MARGIN

PAGE

105

FOLD BACK THIS MARGIN

GATHER

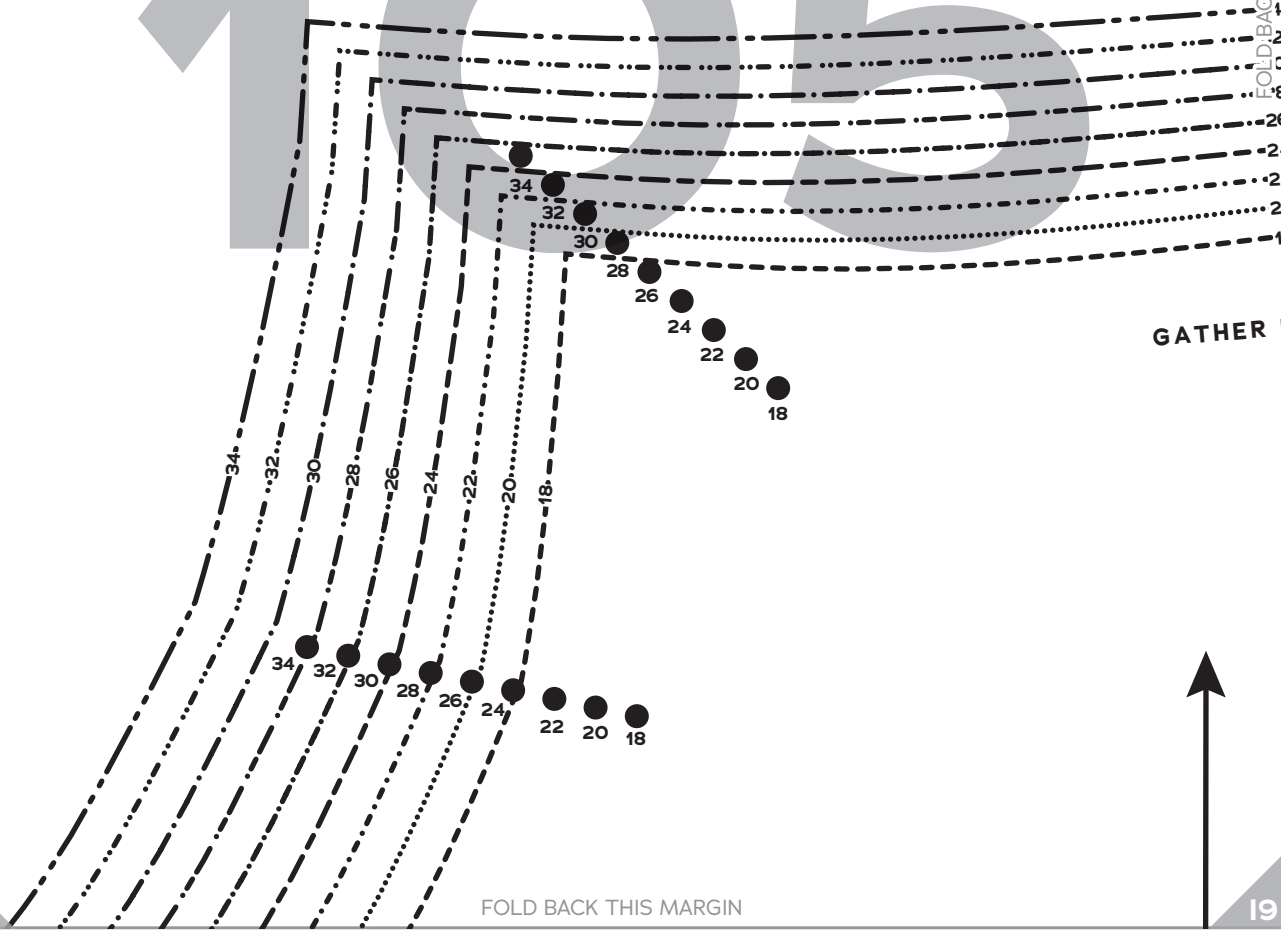

PAGE

406

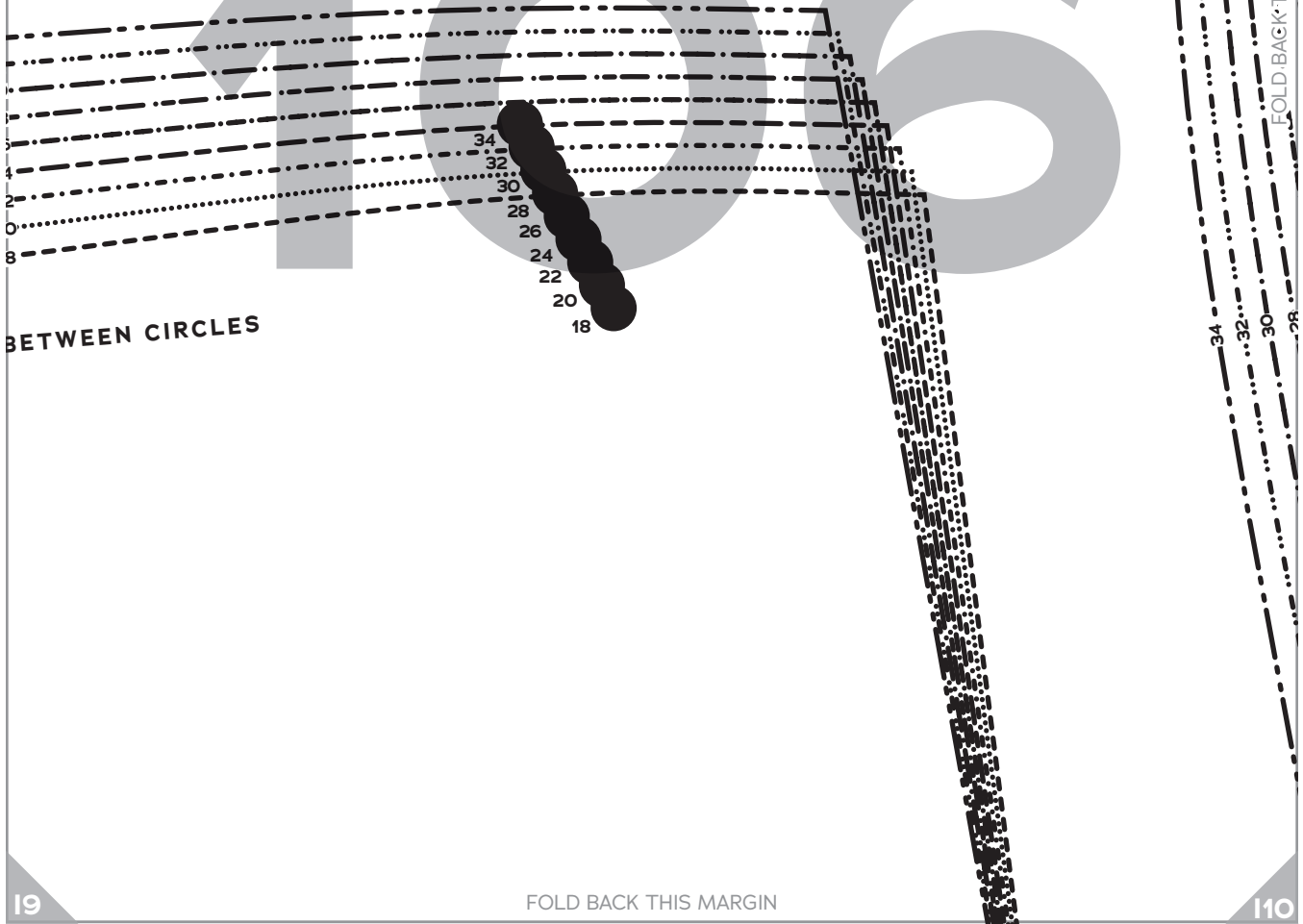

BETWEEN CIRCLES

FOLD BACK THIS MARGIN

H10

H11

PAGE

107

Society of CHARM Society DRESS

SIZES 18-34

1

Bodice Front, A/B Cup

Cut 2 fabric

FOLD BACK THIS MARGIN

GRA

GATHER BETWEEN CIRCLES

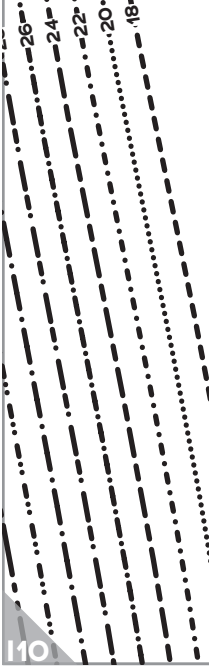
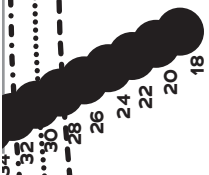

FOLD BACK THIS MARGIN

H10

H11

34
26
18

PAGE.

108

INLINE



GATHER BETWEEN CIRCLES



PAGE

ER BETWEEN CIRCLES

109

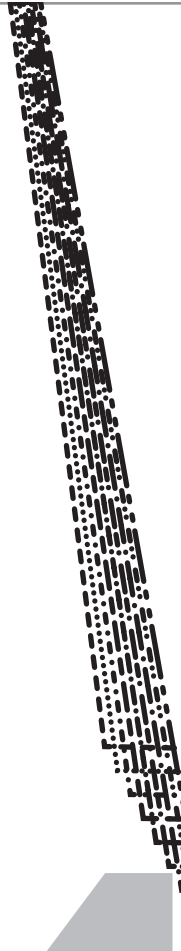

FOLD BACK THIS MARGIN

GATH

PAGE

110

FOLD BACK THIS MARGIN

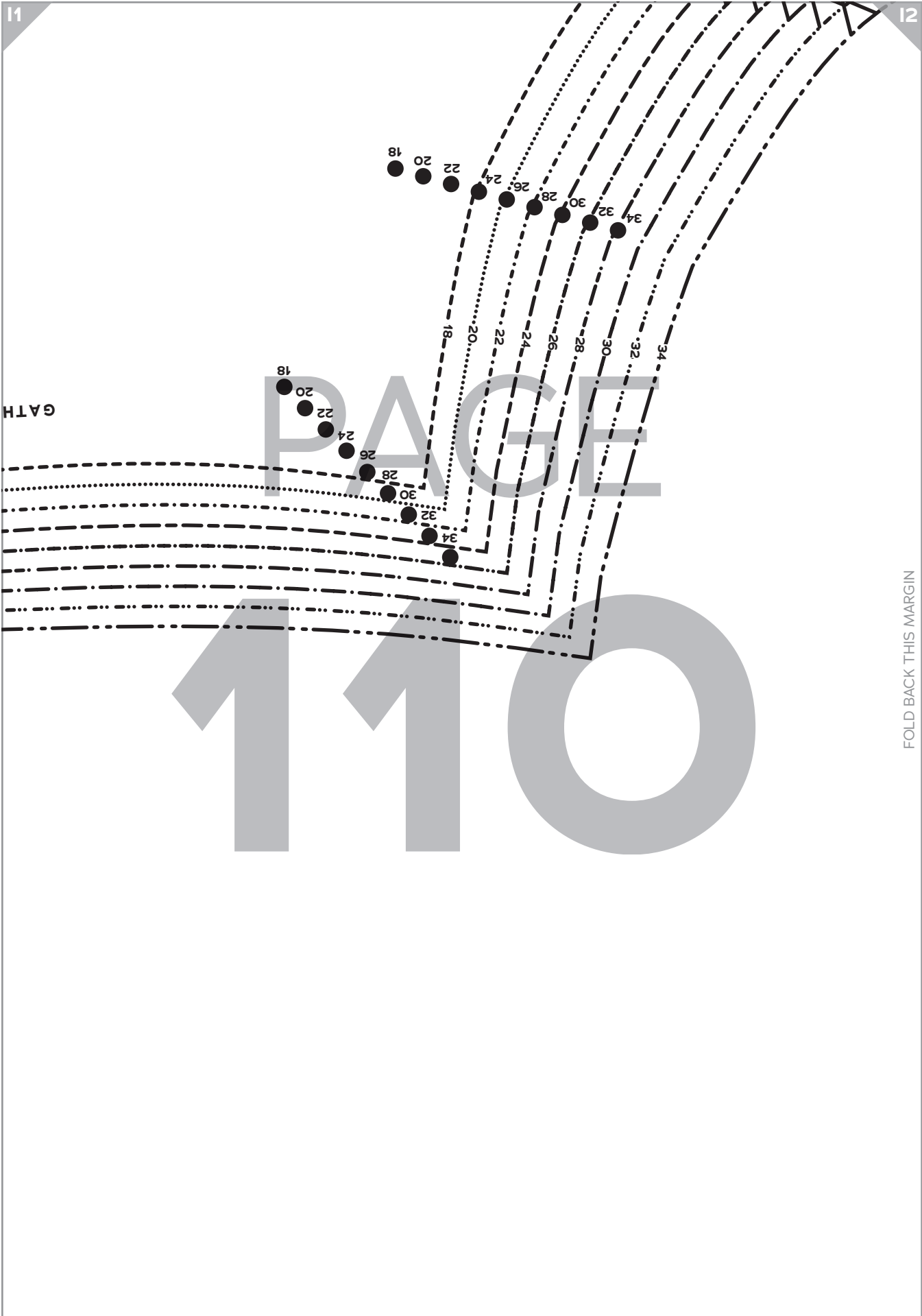

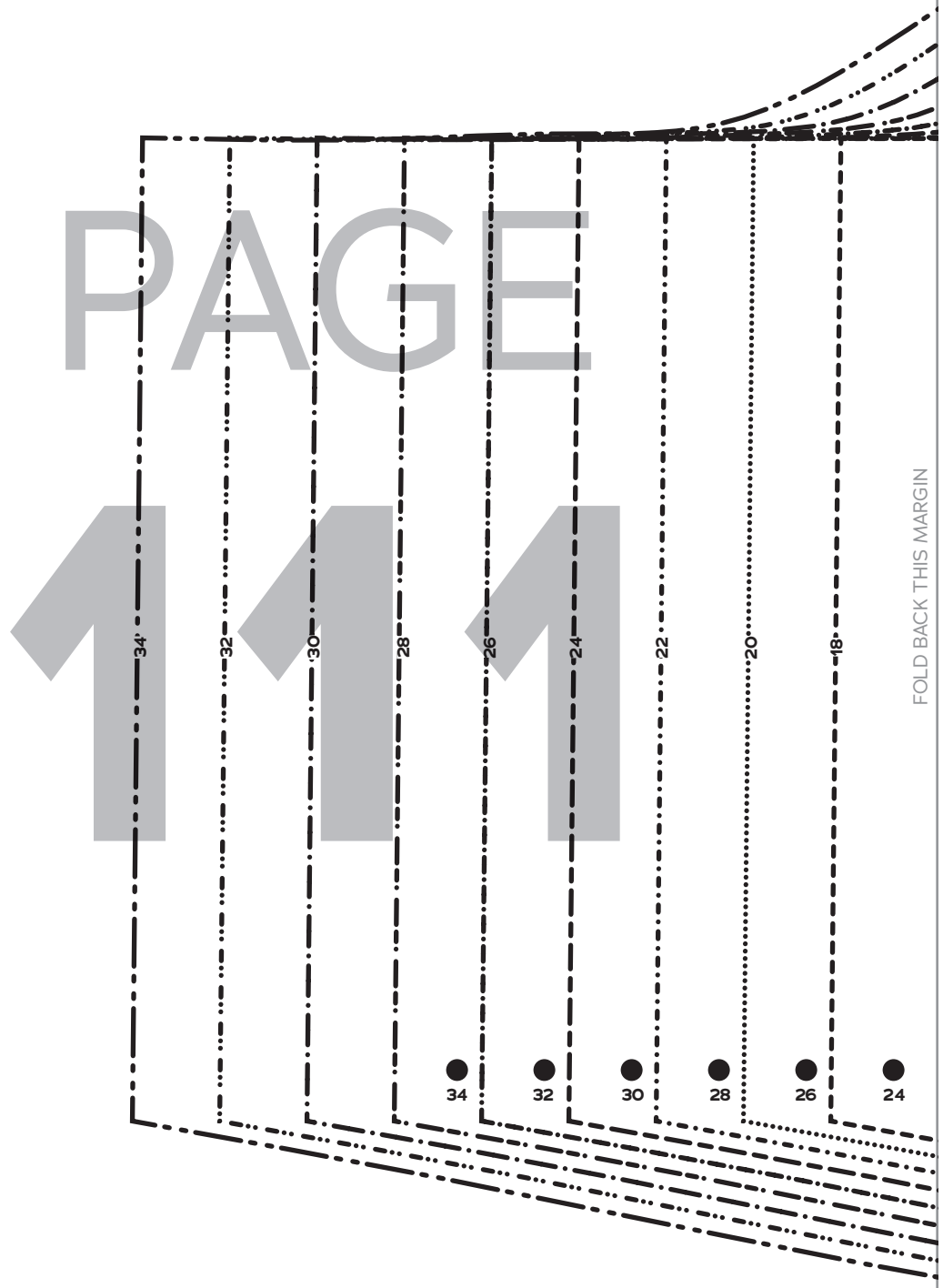

PAGE 111

FOLD BACK THIS MARGIN

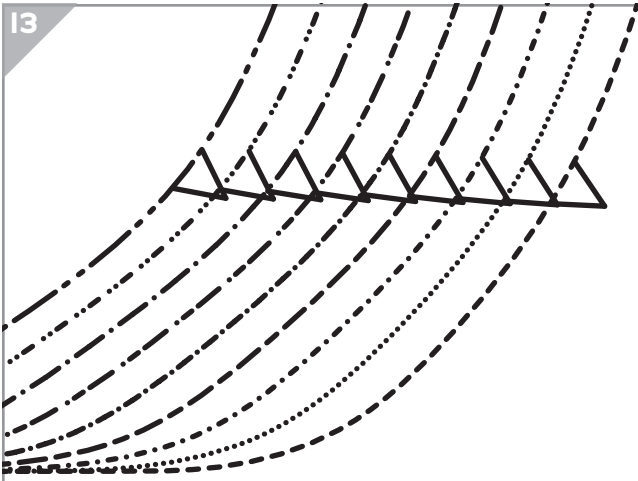

PAGE

112

FOLD BACK THIS MARGIN

●
22

●
20

●
18

GATHER BETWEEN CIRCLES



Society
 & CHARM
Society
DRESS
 SIZES 18-34

GRAINLINE

1
 Bodice Front,
 C Cup
 Cut 2 fabric

PAGE

113

34
 26
 18

FOLD BACK THIS MARGIN



FOLD BACK THIS MARGIN

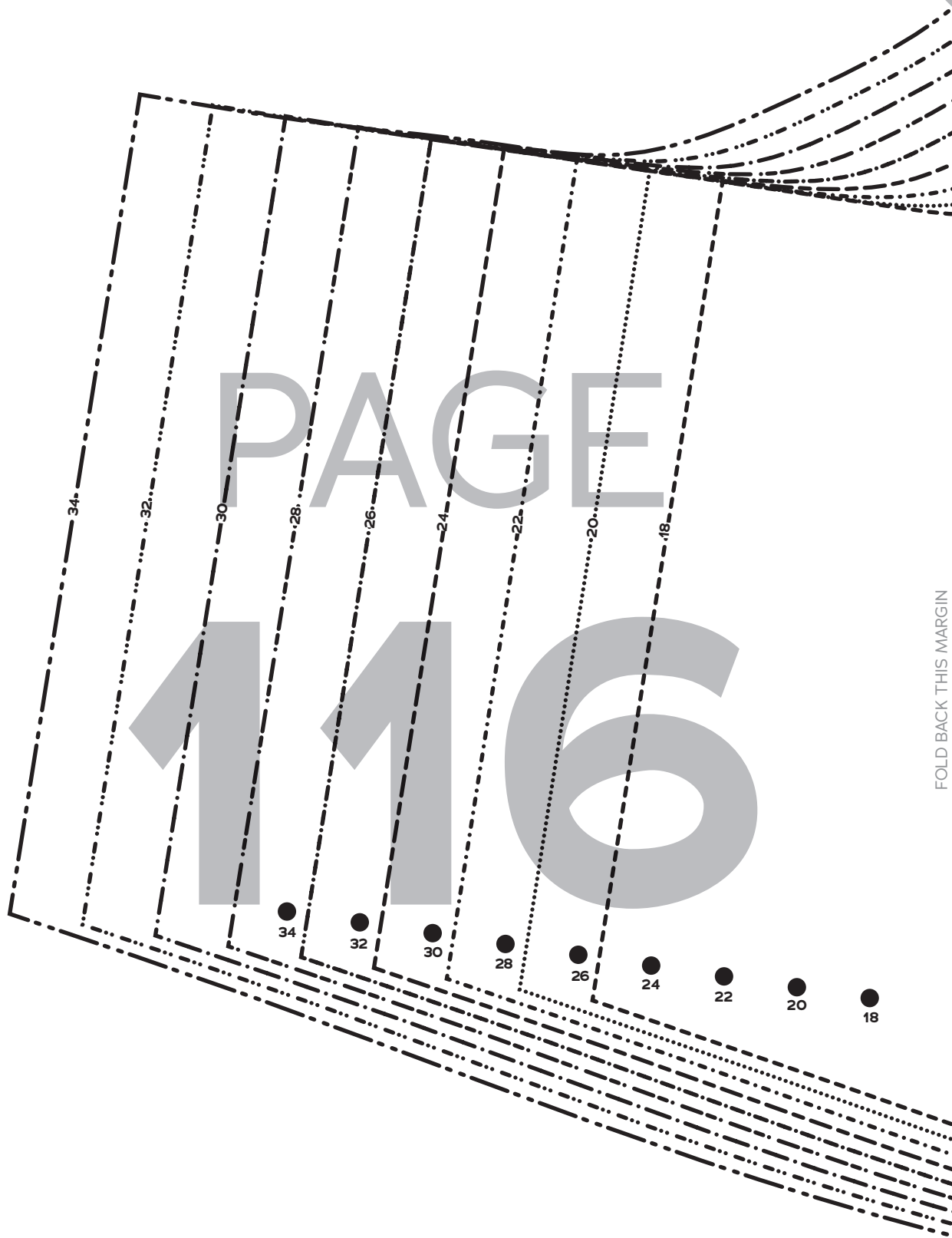

FOLD BACK THIS MARGIN

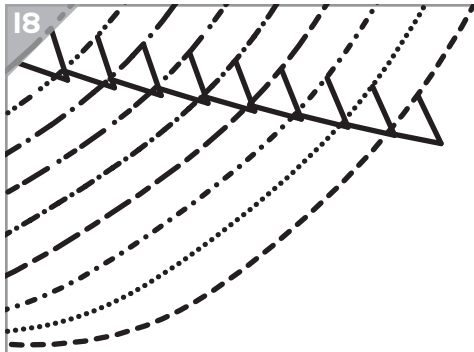

PAGE

117

GRAINLINE

FOLD BACK THIS MARGIN



GATHER BETWEEN CIRCLES

Society
of CHARM
Society
DRESS
SIZES 18-34

1

Bodice Front,
F/G Cup
Cut 2 fabric

PAGE

118

34
26
18

FOLD BACK THIS MARGIN

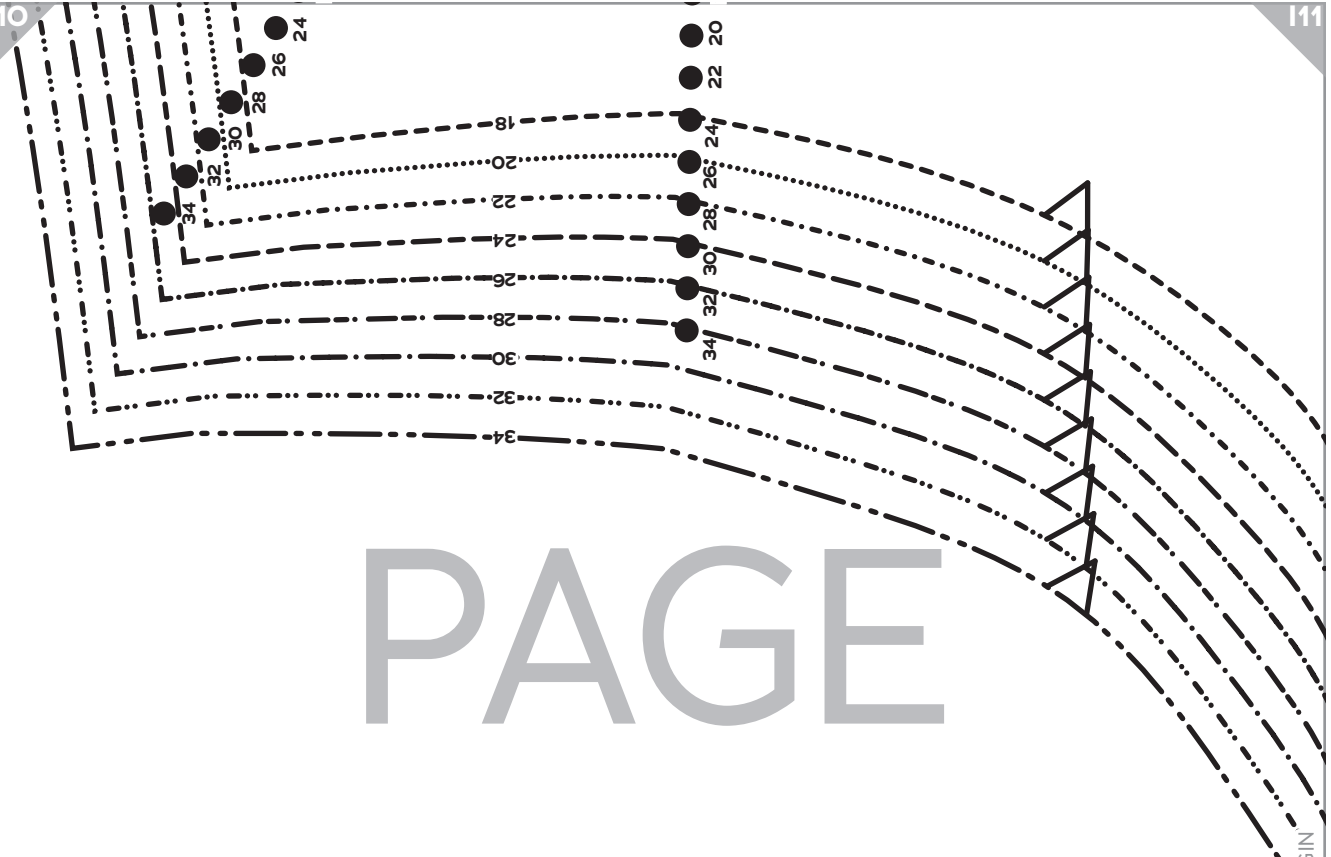

PAGE

119

FOLD BACK THIS MARGIN

PAGE

120

- 18
- 20
- 22
- 24
- 26
- 28
- 30
- 32
- 34