



SIZE 18-34
PATTERN
SIZE KEY

- 18 -----
- 20 (dotted)
- 22 (dotted)
- 24 -----
- 26 (dotted)
- 28 -----
- 30 (dotted)
- 32 (dotted)
- 34 -----

SYMBOL KEY

- grainline arrow
- match point/
placement mark
- ⊕ bust apex
- ✕ button/buttonhole
- ☒ snap

CHARM SCHOOL UNIFORM

Sizes 18-34
with cup sizes A-H

5/8 inch (in) (1.5 cm) seam allowances
are included on all pattern pieces.

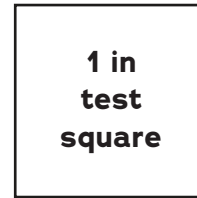
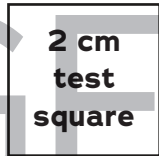

© 2024 Charm Patterns by Gertie
Distribution and Commercial Use Prohibited

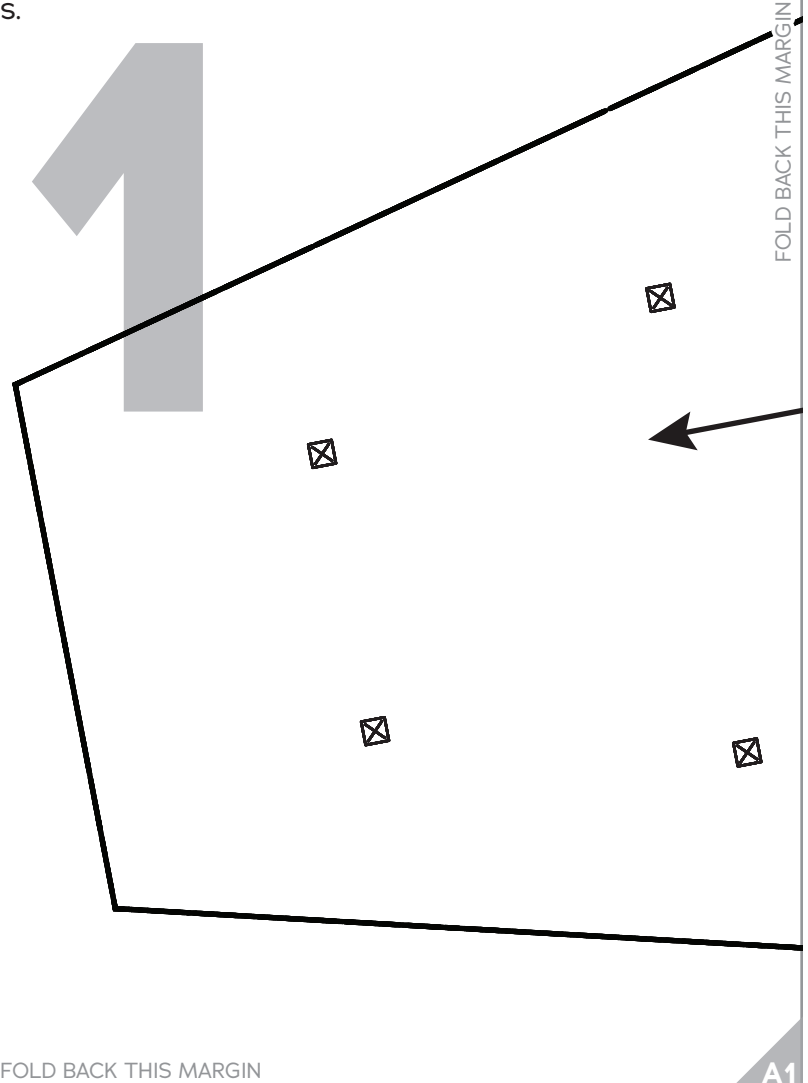

PAGE

2

Charm School
BY GERTIE

CHARM SCHOOL
UNIFORM

SIZES 18-34

Bodice
Front Inset,

A-G Cup

Cut 1 fabric, 1 lining or 1 lace, 2 organza

GRAINLINE

LENGTHEN/SHORTEN LINE

FOLD BACK THIS MARGIN

A1

FOLD BACK THIS MARGIN

A2

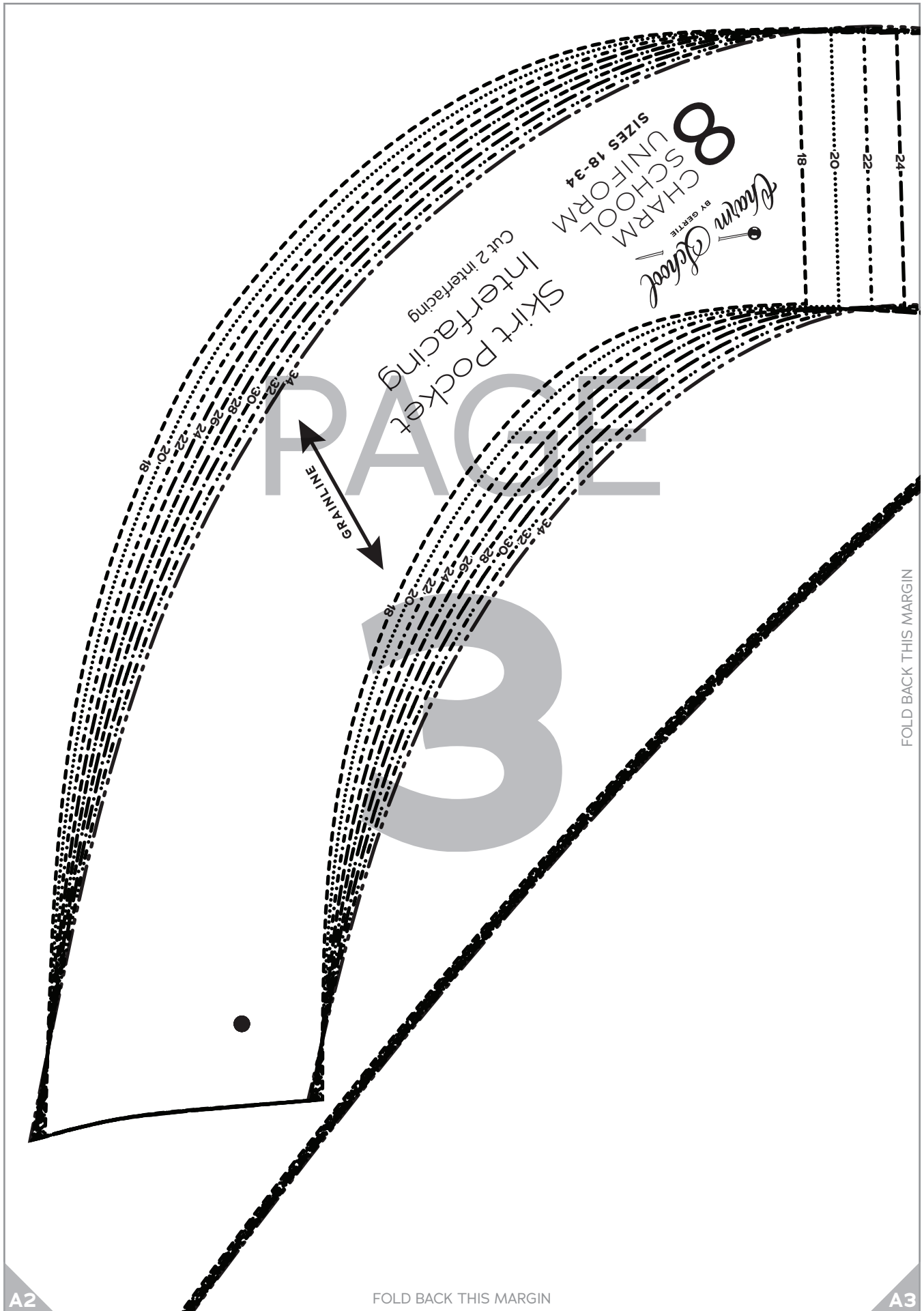

8
CHARM
SCHOOL
UNIFORM
SIZES 18-34
BY GERTIE
Charm School

Skirt pocket
cut 2 interfacing

GRAINLINE

FOLD BACK THIS MARGIN

FOLD BACK THIS MARGIN

A2

A3

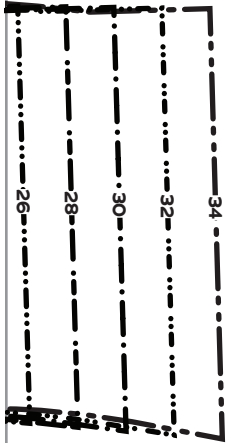

PAGE

4

FOLD BACK THIS MARGIN

FOLD BACK THIS MARGIN

PAGE

5

FOLD BACK THIS MARGIN

A4

FOLD BACK THIS MARGIN

A5

PAGE

6

GRAINLINE

Skirt
Pocket Bag
Cut 2 fabric or lining

7
CHARM SCHOOL
UNIFORM
SIZES 18-34

Charm School
BY GERTIE

FOLD BACK THIS MARGIN

A5

FOLD BACK THIS MARGIN

A6

PAGE

7

FOLD BACK THIS MARGIN

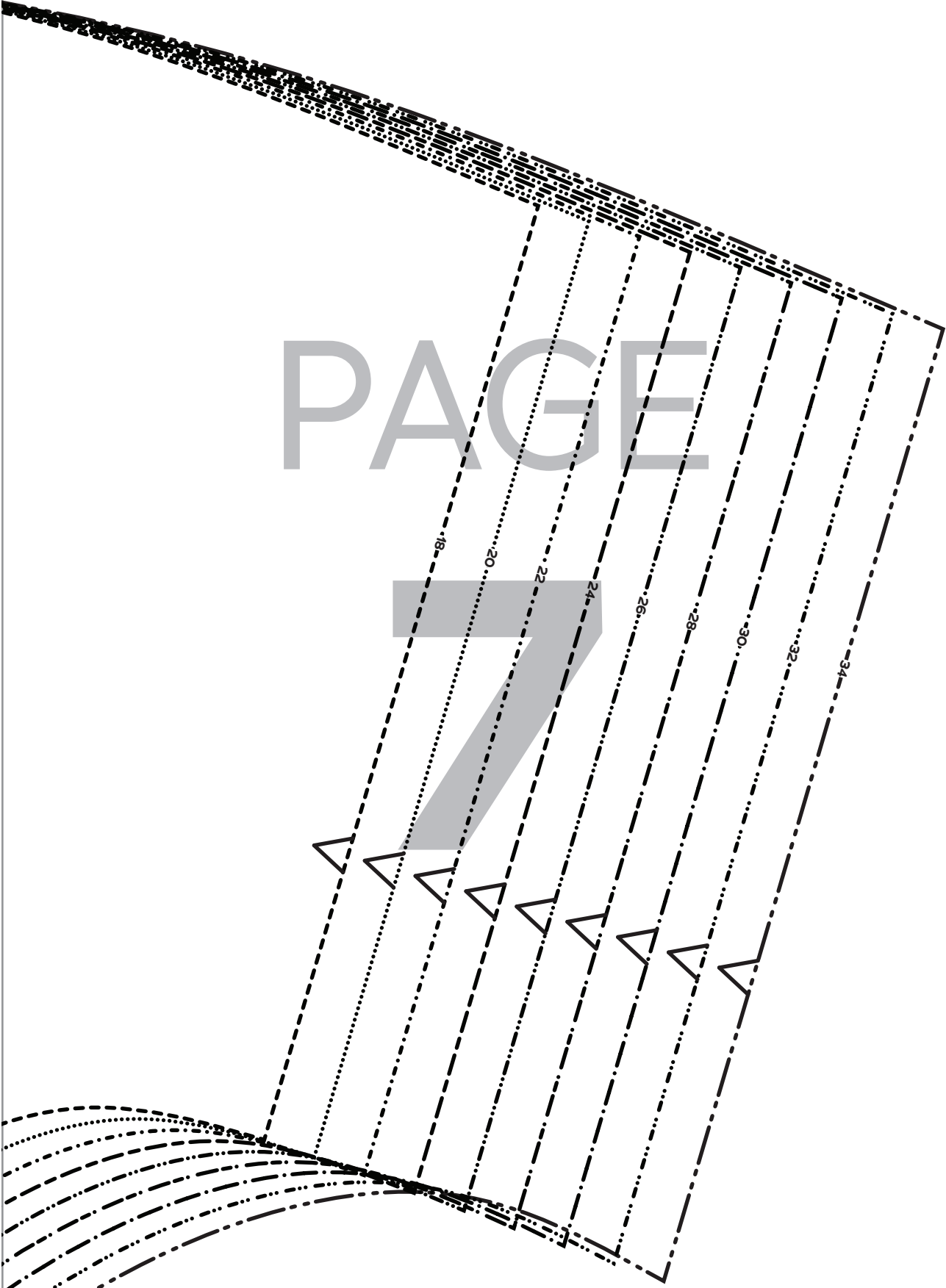

A6

FOLD BACK THIS MARGIN

A7

PAGE



11 CHARM SCHOOL
UNIFORM
SIZES 18-34

FOLD BACK THIS MARGIN

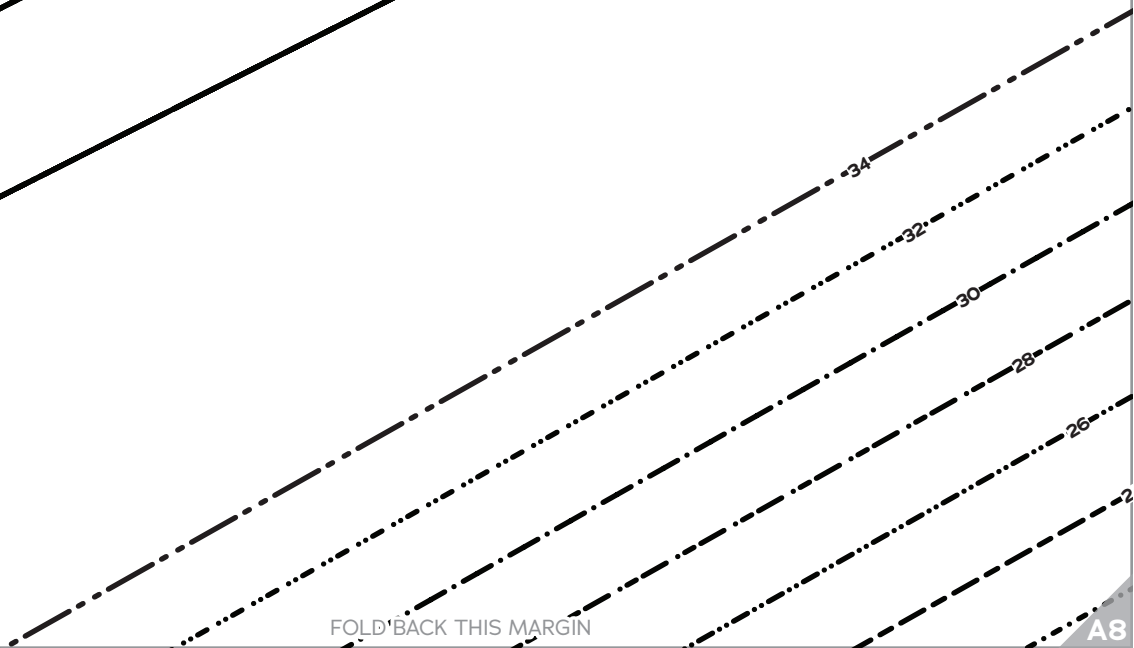

A7

FOLD'BACK THIS MARGIN

A8

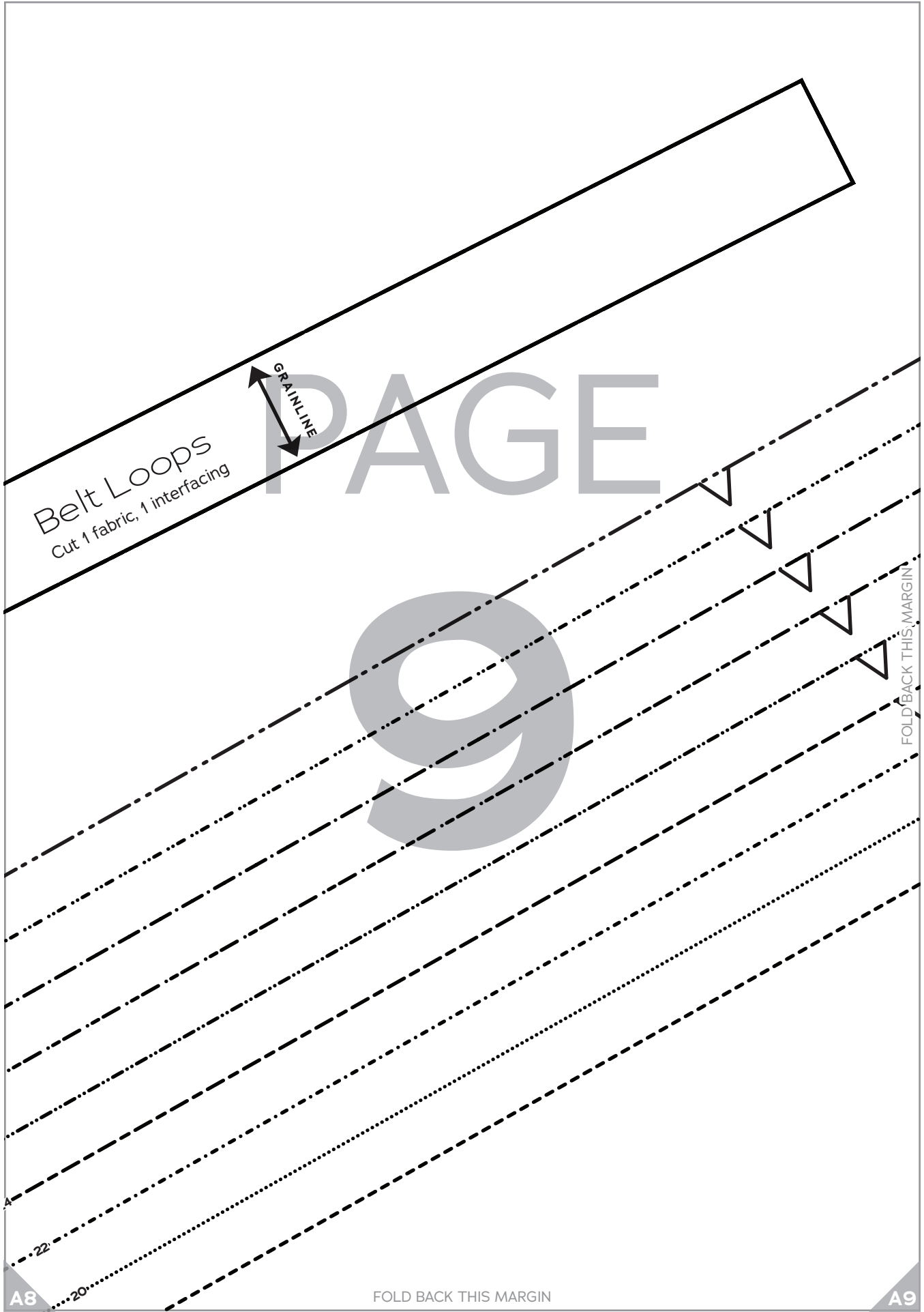

Belt Loops
Cut 1 fabric, 1 interfacing

GRAIN LINE

PAGE

9

FOLD BACK THIS MARGIN

A8

FOLD BACK THIS MARGIN

A9

PAGE

10

FOLD BACK THIS MARGIN

34
32
30
28
26
24
22
20
18

A9

FOLD BACK THIS MARGIN

A10

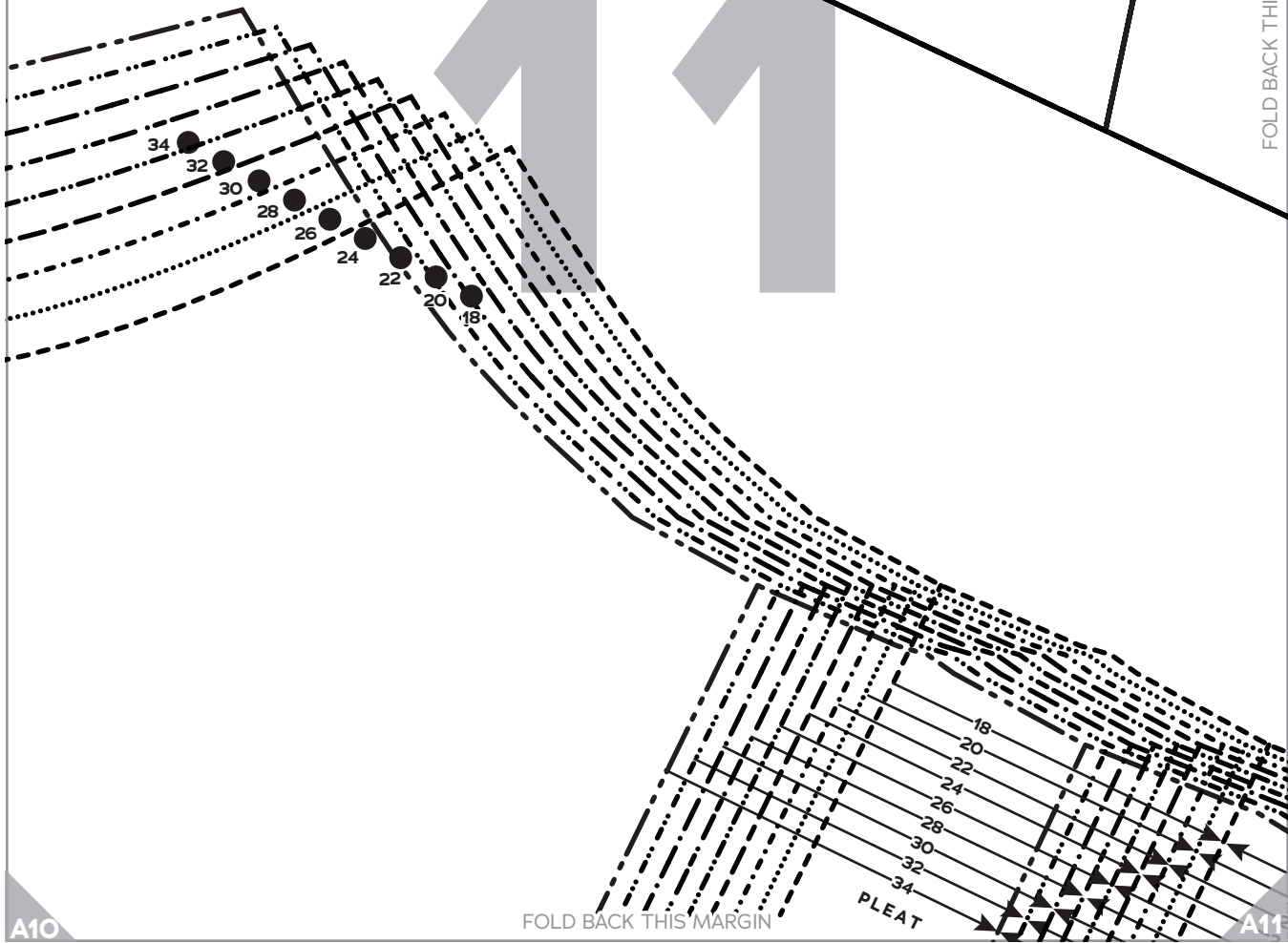
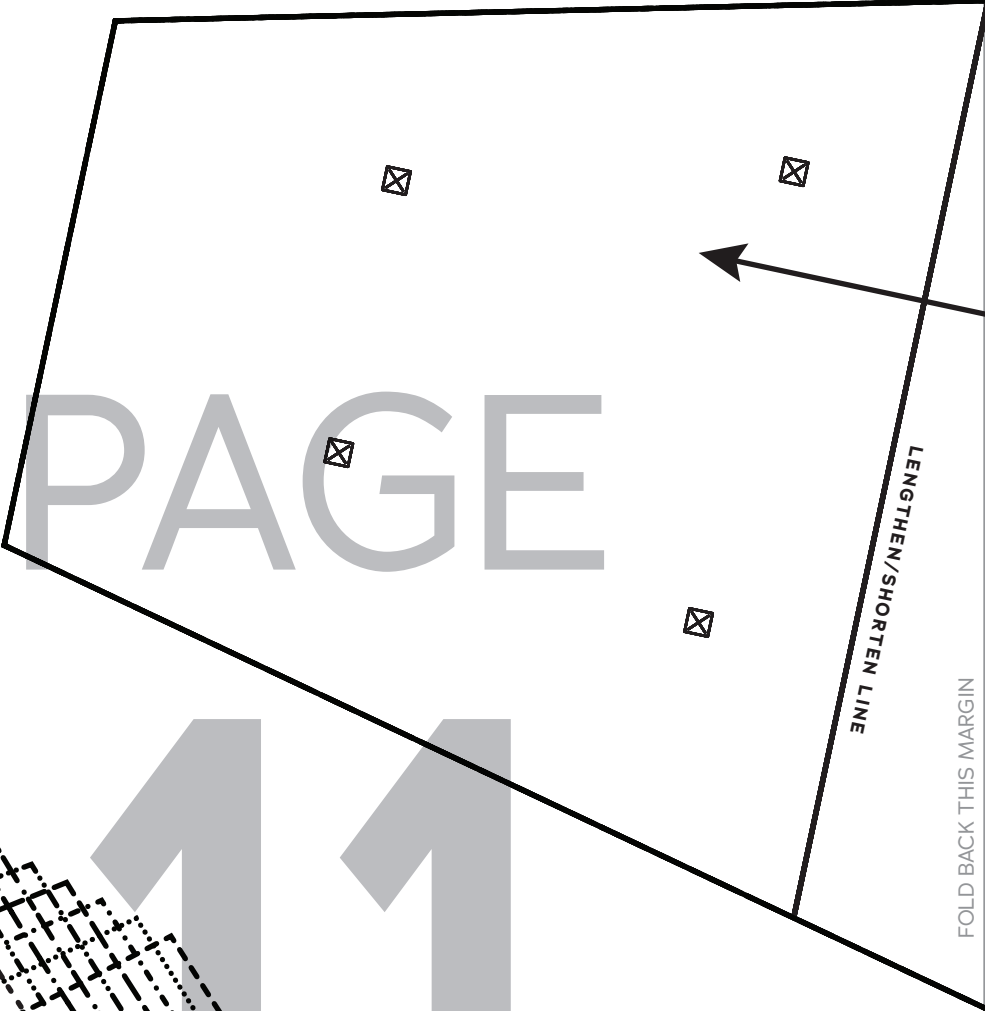

A10

FOLD BACK THIS MARGIN

A11

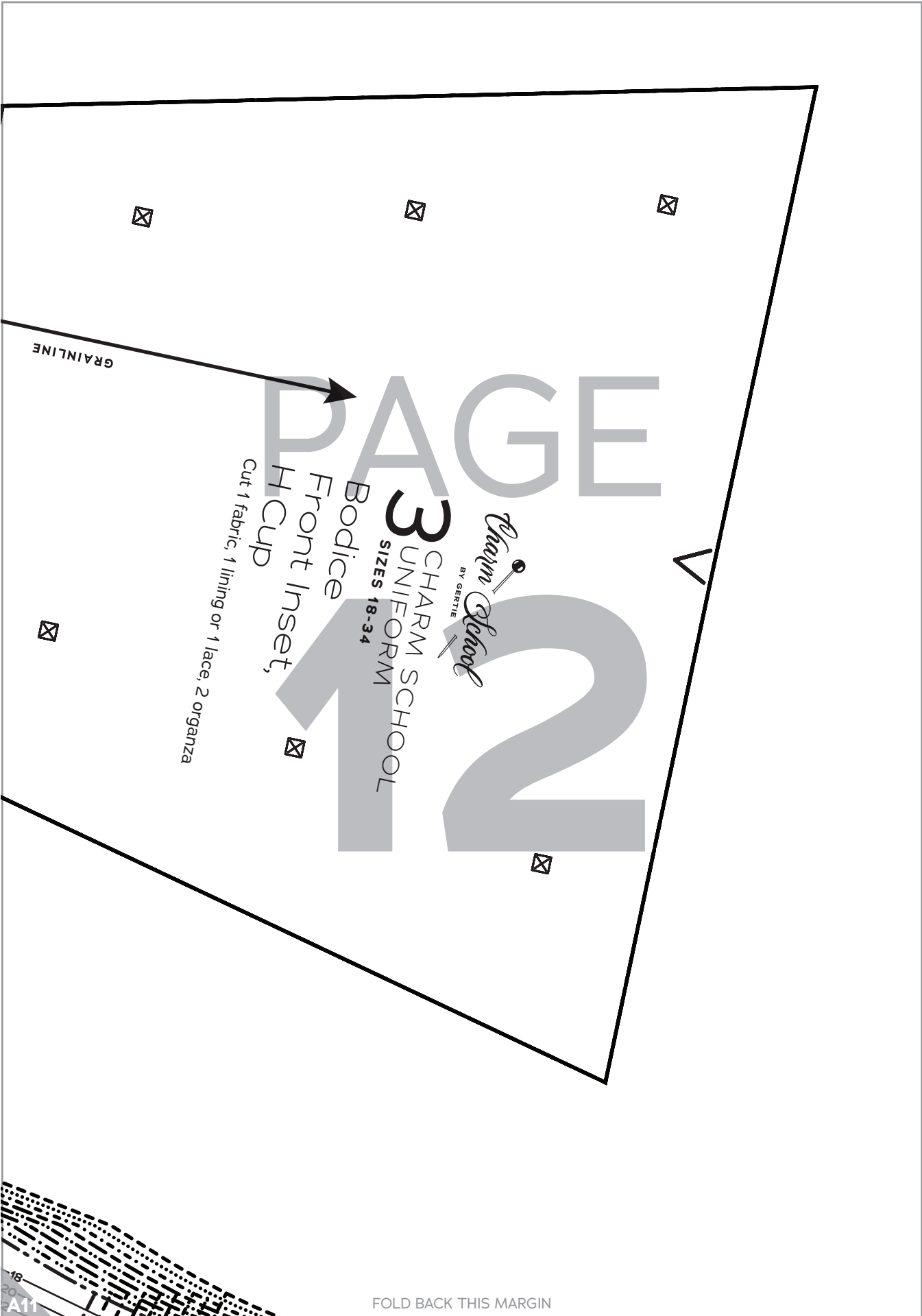

GRAINLINE

PAGE

3 CHARM SCHOOL
UNIFORM
SIZES 18-34

Charm School
BY GERTIE

Bodice
Front Inset,
H Cup
Cut 1 fabric, 1 lining or 1 lace, 2 organza



FOLD BACK THIS MARGIN

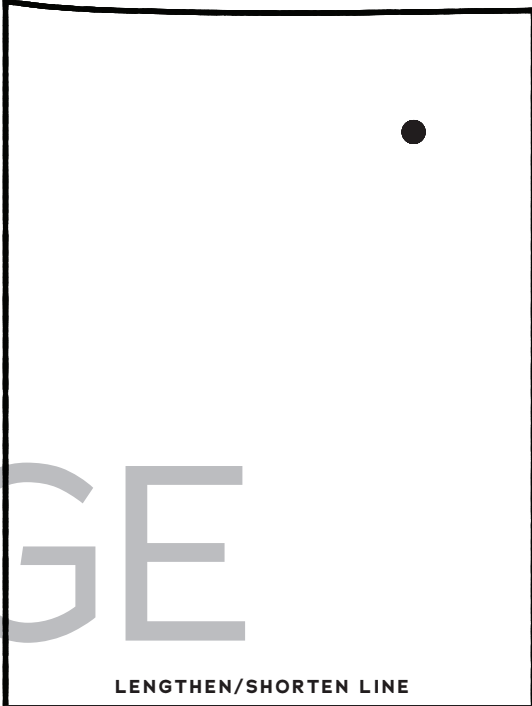
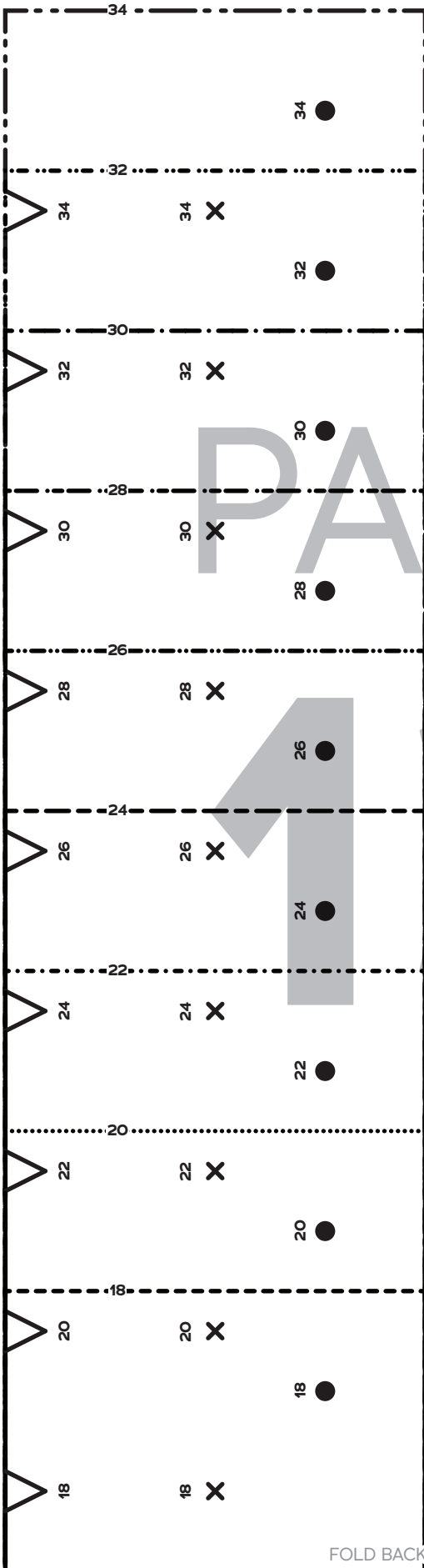

LENGTHEN/SHORTEN LINE

Charm School
BY GERTIE

9 CHARM SCHOOL
UNIFORM
SIZES 18-34

Skirt Front
Facing

Cut 2 fabric, 2 interfacing

FOLD BACK THIS MARGIN

FOLD BACK THIS MARGIN



A1

A2

PAGE

14

FOLD BACK THIS MARGIN

B1

FOLD BACK THIS MARGIN

B2

A2

A3

PAGE

15

FOLD BACK THIS MARGIN

B2

FOLD BACK THIS MARGIN

B3

A3

A4

PAGE

16

FOLD BACK THIS MARGIN

B3

FOLD BACK THIS MARGIN

B4

A4

A5

PAGE

17

FOLD

FOLD BACK THIS MARGIN

B4

FOLD BACK THIS MARGIN

B5

A5

A6

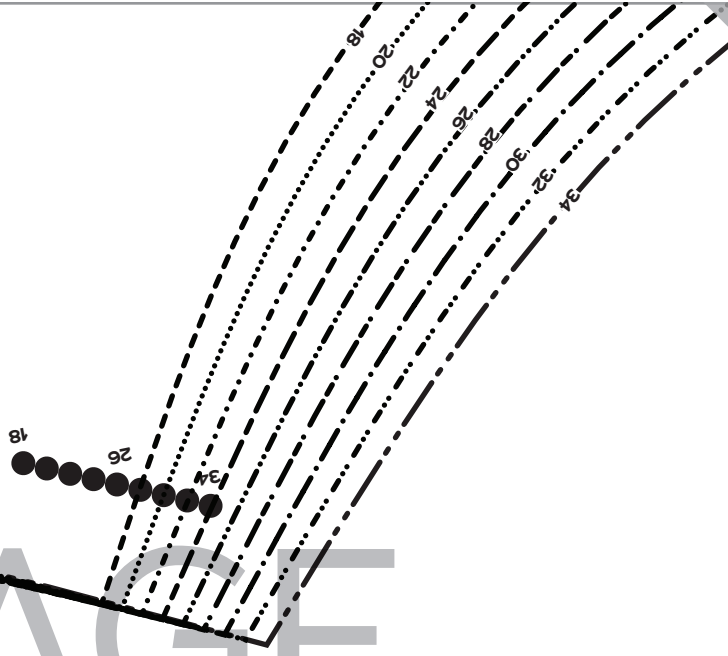

PAGE

18

FOLD BACK THIS MARGIN

B5

FOLD BACK THIS MARGIN

B6

A6

A7

PAGE

19

FOLD BACK THIS MARGIN

B6

FOLD BACK THIS MARGIN

B7

A7

A8

PAGE

20

FOLD BACK THIS MARGIN

B7

FOLD BACK THIS MARGIN

B8

A8

A9

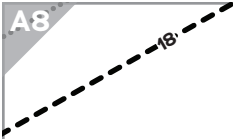

PAGE

21

FOLD BACK THIS MARGIN

B8

FOLD BACK THIS MARGIN

B9

A9

A10



4 CHARM SCHOOL UNIFORM SIZES 18-34

Skirt Front
Cut 2 fabric



PAGE

22

FOLD BACK THIS MARGIN

B9

FOLD BACK THIS MARGIN

B10

A10

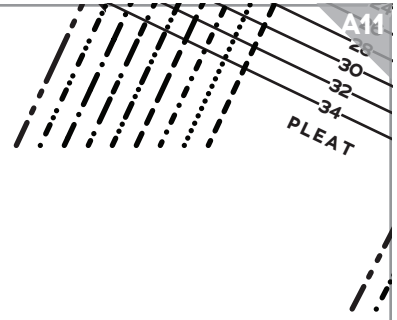

PAGE

LENGTHEN/SHORTEN LINE

23

FOLD BACK THIS MARGIN

B10

FOLD BACK THIS MARGIN

B11

A11

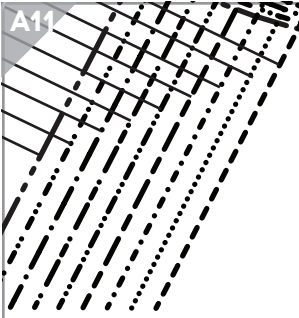

PAGE

24



B11

FOLD BACK THIS MARGIN

PAGE
25

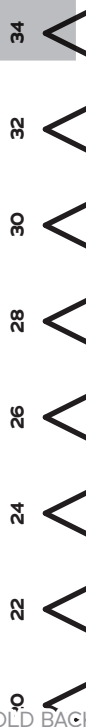
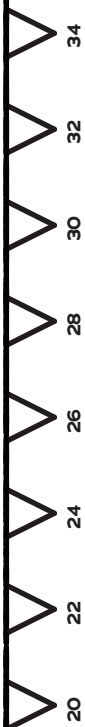

GRAINLINE

FOLD BACK THIS MARGIN

FOLD BACK THIS MARGIN

B1

B2

PAGE 26

FOLD BACK THIS MARGIN

C1

FOLD BACK THIS MARGIN

C2

B2

B3

PAGE

27

FOLD BACK THIS MARGIN

C2

FOLD BACK THIS MARGIN

C3

B3

B4

PAGE

28

FOLD BACK THIS MARGIN

LENGTHEN/SHORTEN LINE

C3

FOLD BACK THIS MARGIN

C4

B4

B5

PAGE

29

FOLD BACK THIS MARGIN

cut 1 fabric on fold
 Skirt Back
 5
 SIZES 18-34
 CHARM SCHOOL
 BY GERTIE
 Charm School

C4

FOLD BACK THIS MARGIN

C5

B5

B6

PAGE

30

FOLD BACK THIS MARGIN

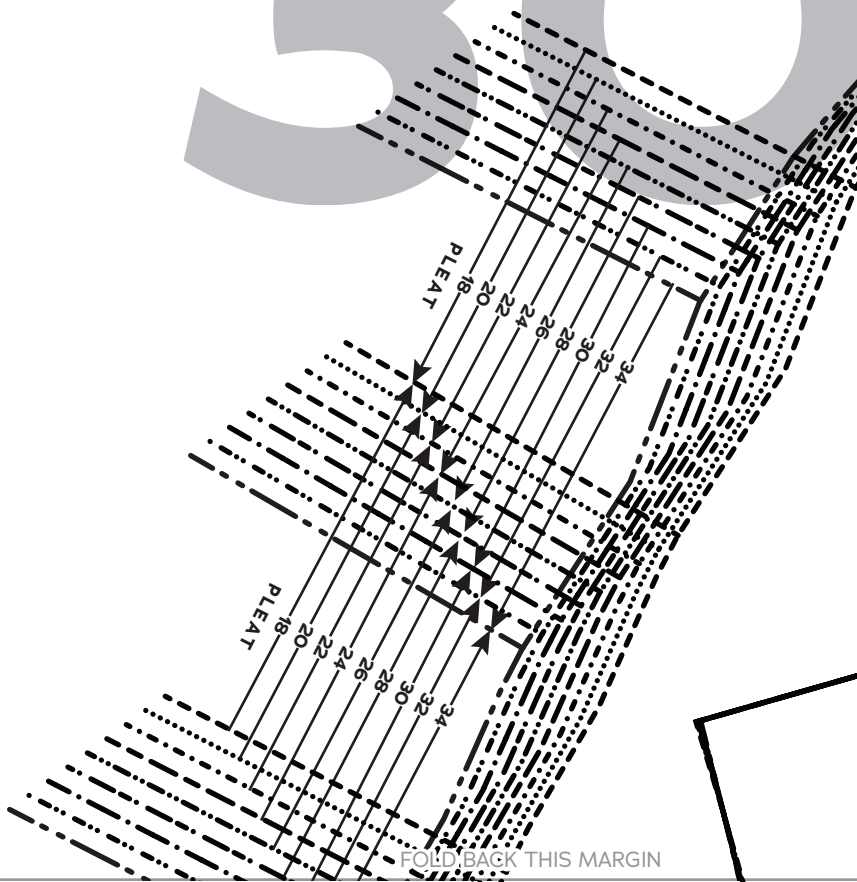

FOLD BACK THIS MARGIN

C5

C6

B6

B7

PAGE

31

FOLD BACK THIS MARGIN

C6

FOLD BACK THIS MARGIN

C7

B7

B8

PAGE

32

FOLD BACK THIS MARGIN

C7

FOLD BACK THIS MARGIN

C8

B8

B9

PAGE

33

FOLD BACK THIS MARGIN

C8

FOLD BACK THIS MARGIN

C9

B9

B10

PAGE

34

GRAINLINE

FOLD BACK THIS MARGIN

C9

FOLD BACK THIS MARGIN

C10

B10

B11

PAGE

35

FOLD BACK THIS MARGIN

C10

FOLD BACK THIS MARGIN

C11

x

PAGE

36

x

x

C1



PAGE

37



FOLD BACK THIS MARGIN

FOLD BACK THIS MARGIN

D1

C1

C2

PAGE

38

FOLD BACK THIS MARGIN

D1

FOLD BACK THIS MARGIN

D2

C2

C3

PAGE

39

FOLD BACK THIS MARGIN

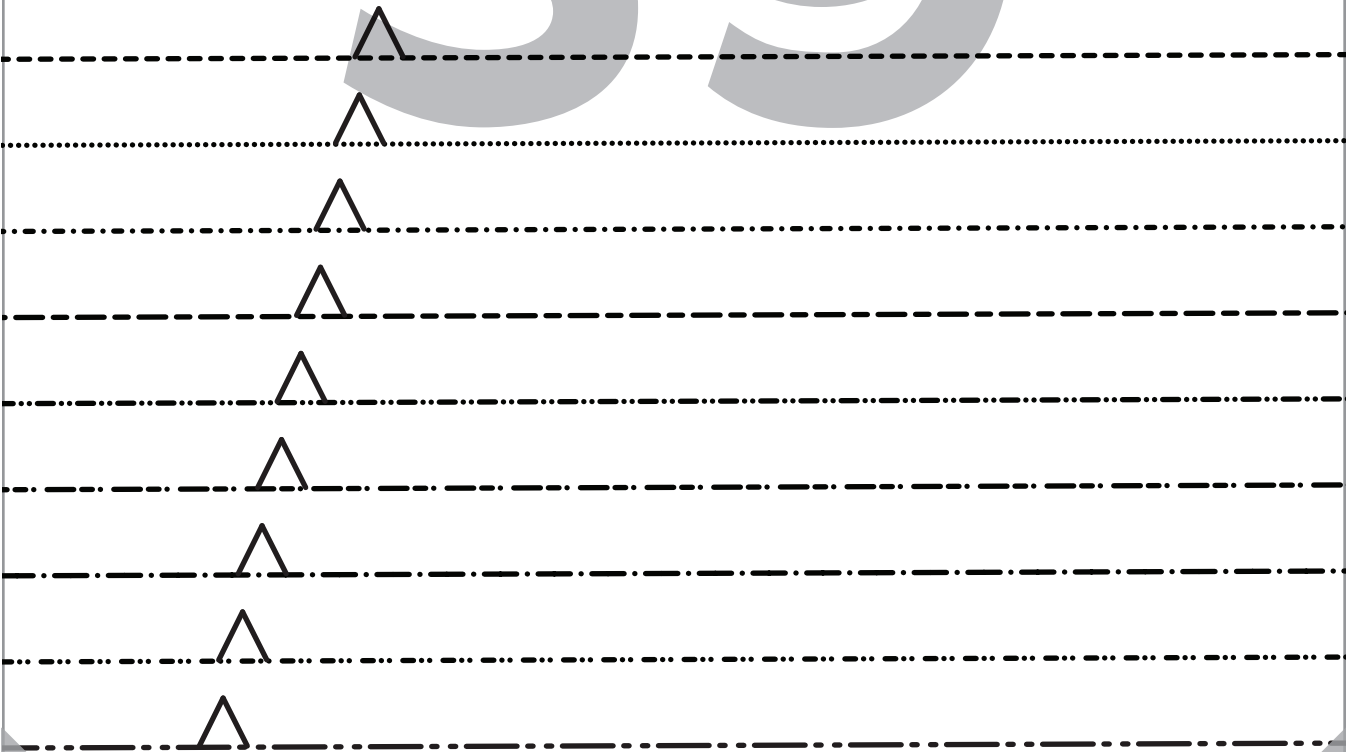

D2

FOLD BACK THIS MARGIN

D3

C3

C4

PAGE

40

FOLD BACK THIS MARGIN

18

20

22

24

26

28

30

32

34

D3

FOLD BACK THIS MARGIN

D4

PAGE

41

FOLD BACK THIS MARGIN

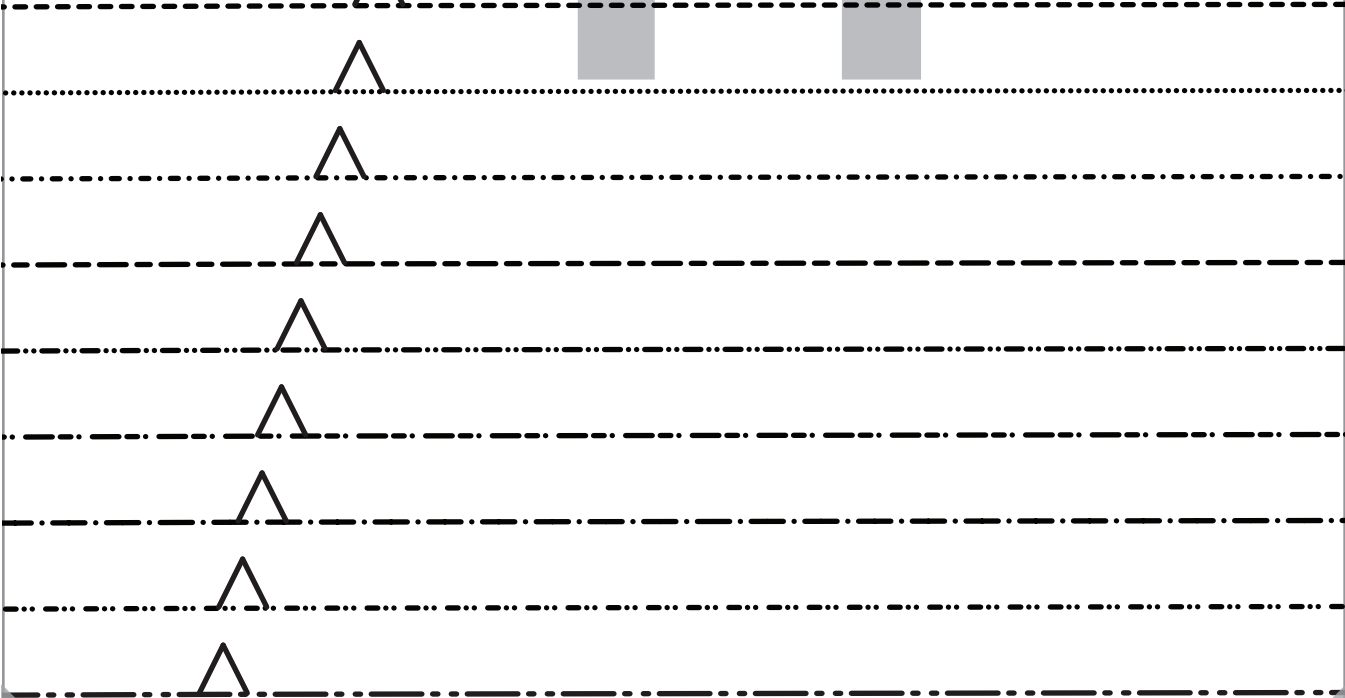

C5

C6



PAGE
42



FOLD BACK THIS MARGIN

D5

FOLD BACK THIS MARGIN

D6

C6

C7

GRAINLINE

PAGE 9

Charm Patterns
BY GERTIE
CHARM SCHOOL
UNIFORM
SIZES 18-34
Skirt Side Front
cut 2 fabric

43

FOLD BACK THIS MARGIN

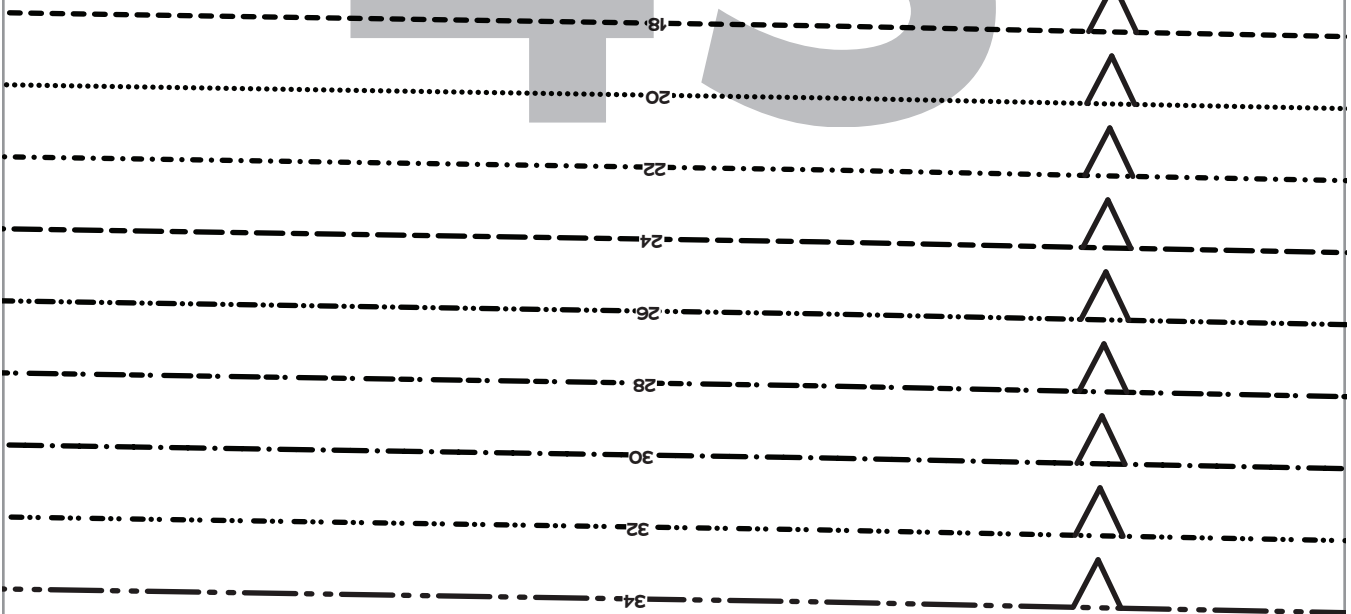

D6

FOLD BACK THIS MARGIN

D7

C7

C8

PAGE

44

FOLD BACK THIS MARGIN

D7

FOLD BACK THIS MARGIN

D8

C8

C9

PAGE

45

FOLD BACK THIS MARGIN

D8

FOLD BACK THIS MARGIN

D9

C9

C10



PAGE

46

FOLD BACK THIS MARGIN

D9

FOLD BACK THIS MARGIN

D10

C10

C11

PAGE

47

FOLD BACK THIS MARGIN

D10

FOLD BACK THIS MARGIN

D11

C11

x

PAGE

48

D11

FOLD BACK THIS MARGIN



CHARM SCHOOL
UNIFORM
SIZES 18-34

10

Waistband

Cut 2 fabric, 1 interfacing

PAGE

49



FOLD BACK THIS MARGIN

FOLD BACK THIS MARGIN

D1

D2

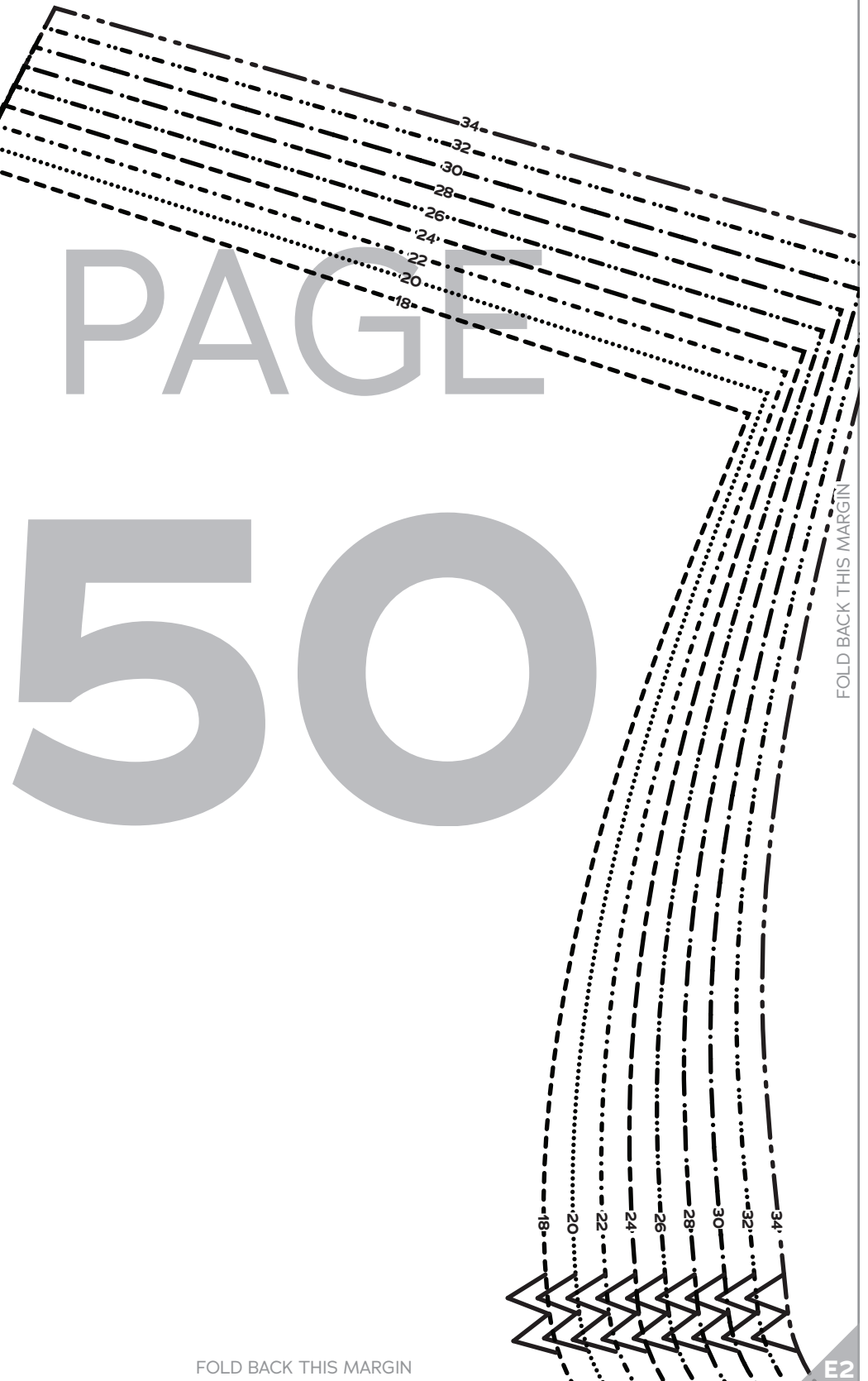

PAGE

50

FOLD BACK THIS MARGIN

FOLD BACK THIS MARGIN

E1

E2

D2

D3

PAGE

51

FOLD BACK THIS MARGIN

E2

FOLD BACK THIS MARGIN

E3

D3

D4

PAGE 52

FOLD BACK THIS MARGIN

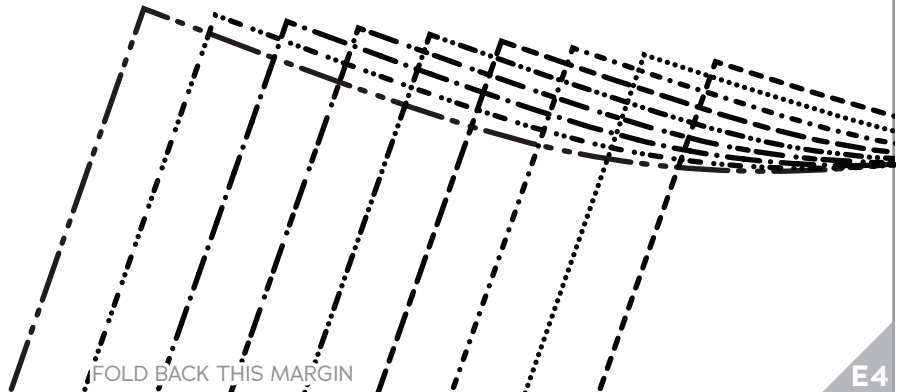

E3

FOLD BACK THIS MARGIN

E4

D4

D5

PAGE 53

FOLD BACK THIS MARGIN

E4

FOLD BACK THIS MARGIN

E5

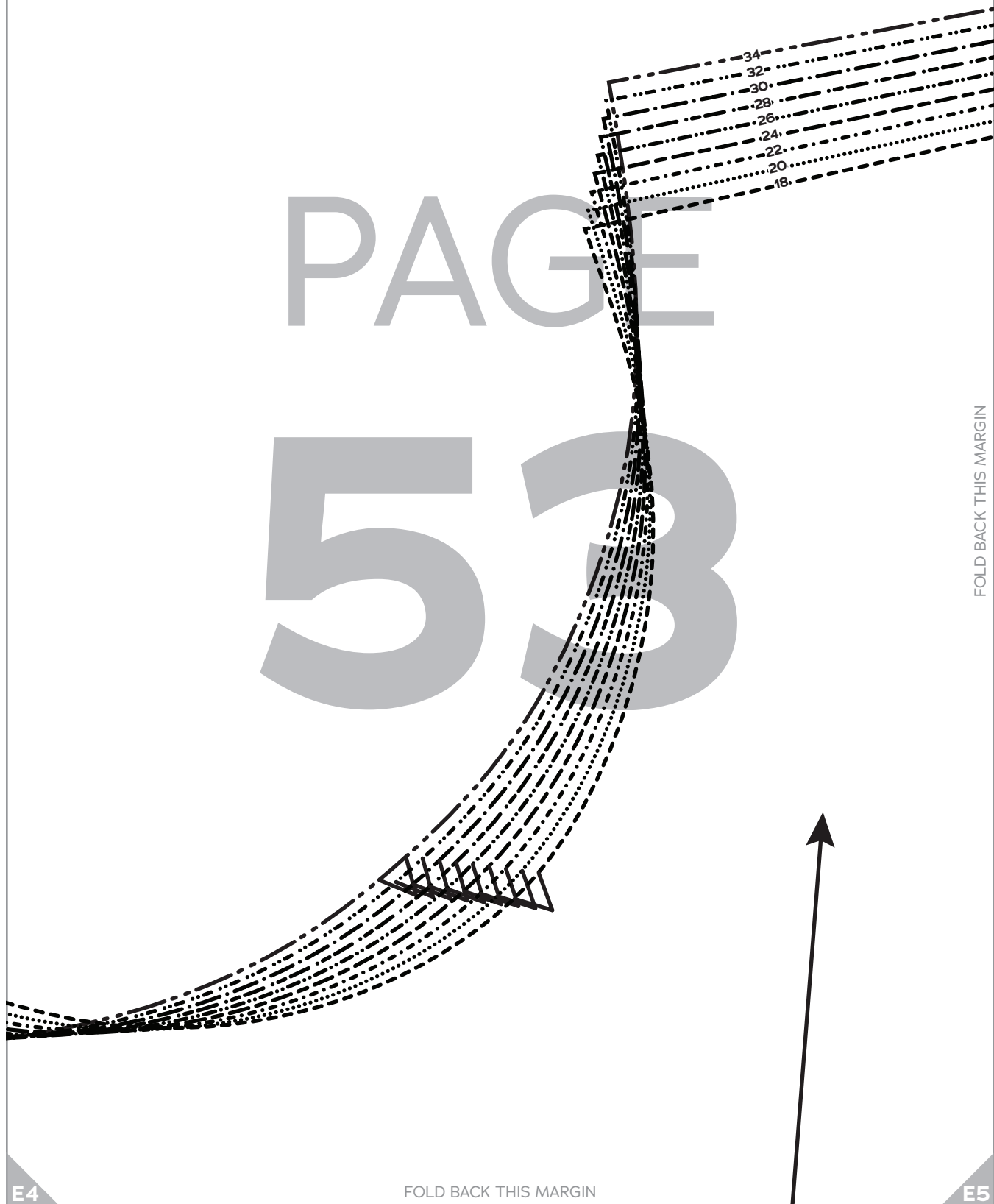

D5

D6

PAGE 54

FOLD BACK THIS MARGIN

Charm School
BY GERTIE

1 CHARM SCHOOL
UNIFORM
SIZES 18-34

Bodice Front,
C Cup

Cut 2 fabric, 2 lining

FOLD BACK THIS MARGIN

E5

E6

D6

D7

PAGE 55

FOLD BACK THIS MARGIN

E6

FOLD BACK THIS MARGIN

E7

D7

D8

PAGE

56

Charm School
BY GERTIE

1 CHARM SCHOOL
UNIFORM
SIZES 18-34

Bodice Front,
A/B Cup
Cut 2 fabric, 2 lining

FOLD BACK THIS MARGIN

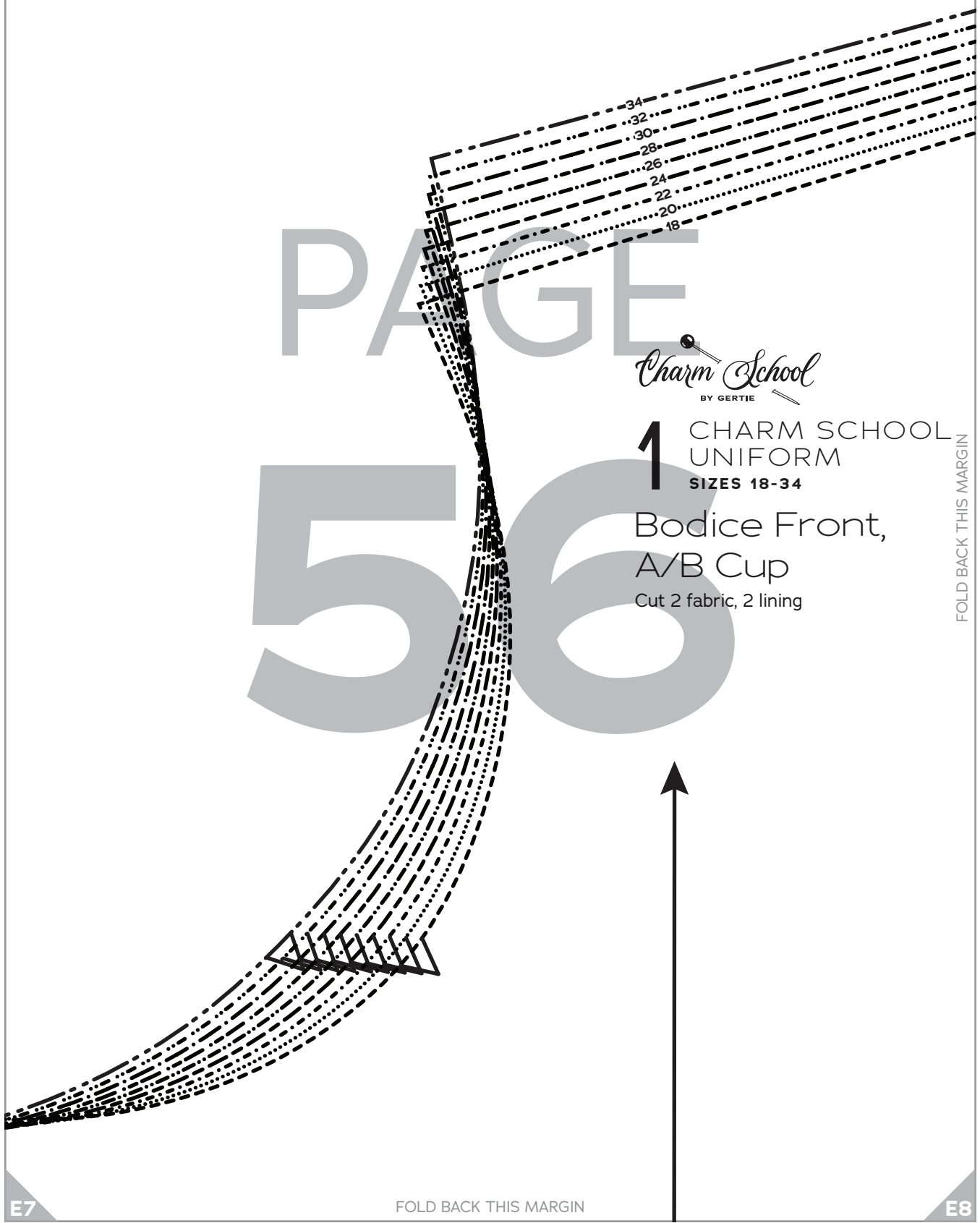

E7

FOLD BACK THIS MARGIN

E8

D8

D9

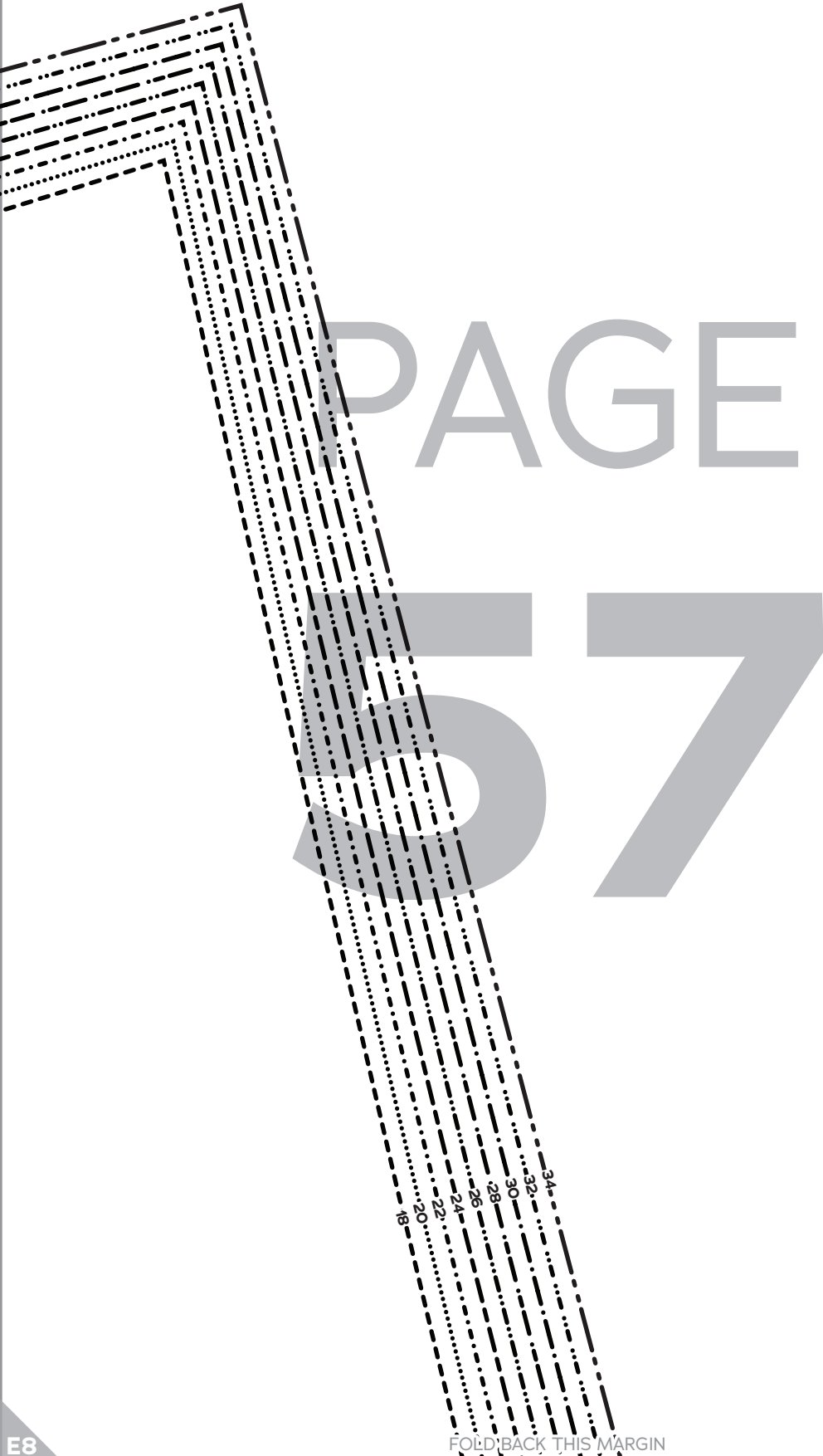

FOLD BACK THIS MARGIN

E8

FOLD BACK THIS MARGIN

E9

D9

D10

PAGE

58

FOLD BACK THIS MARGIN

E9

FOLD BACK THIS MARGIN

E10

D10

D11

PAGE

59

Charm School
BY GERTIE

1 CHARM SCHOOL
UNIFORM
SIZES 18-34

Bodice Front,
D/DD Cup
Cut 2 fabric, 2 lining

FOLD BACK THIS MARGIN

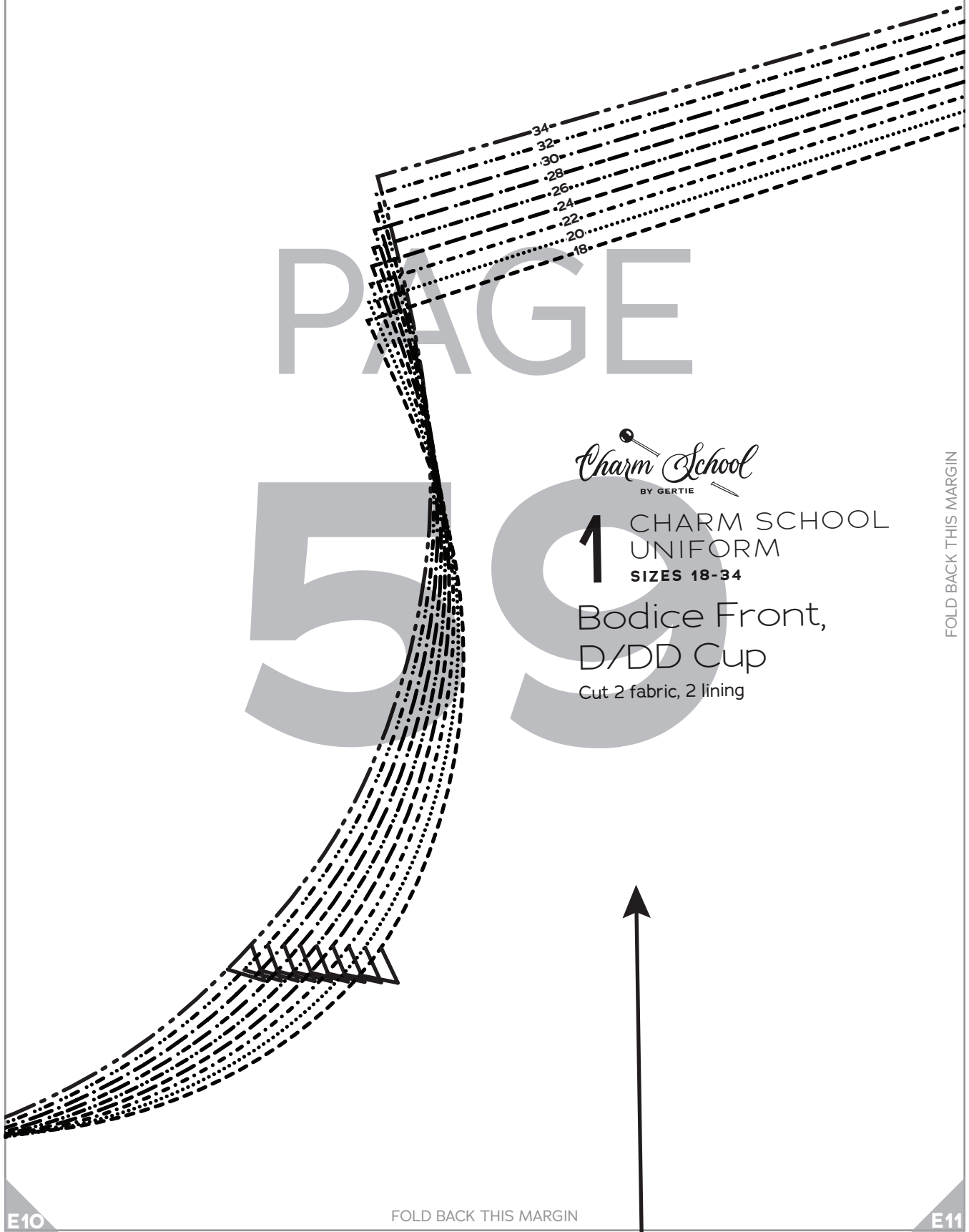

E10

FOLD BACK THIS MARGIN

E11

D11

PAGE

60

34
32
30
28
26
24
22
20
18

FOLD BACK THIS MARGIN

E11

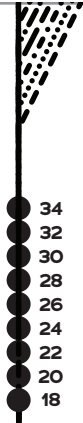
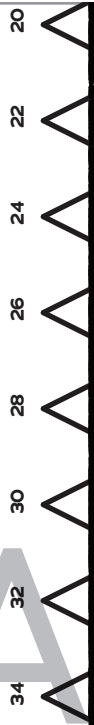
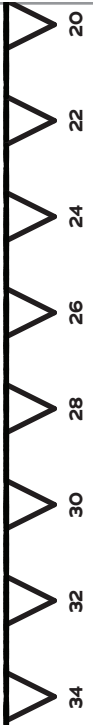

PAGE 6



FOLD BACK THIS MARGIN

FOLD BACK THIS MARGIN

E1

E2



2 CHARM SCHOOL UNIFORM SIZES 18-34

Bodice Back

Cut 1 fabric on fold, 1 lining on fold

PAGE

2

FOLD BACK THIS MARGIN

LENGTHEN/SHORTEN LINE

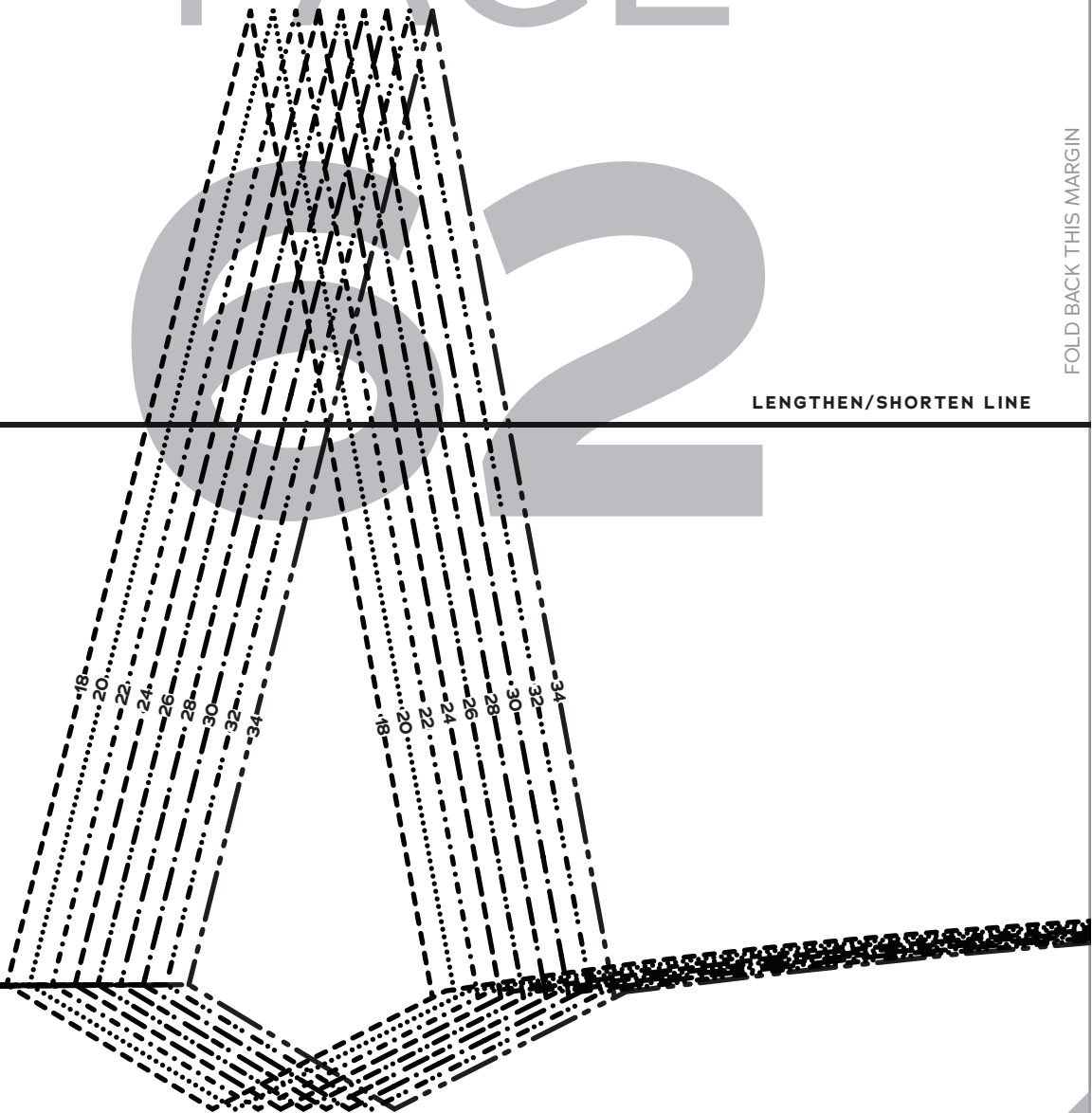

F1

FOLD BACK THIS MARGIN

F2

E2

E3

PAGE

63

FOLD BACK THIS MARGIN

18

20

22

24

26

28

30

32

34

F2

FOLD BACK THIS MARGIN

F3

E3

E4

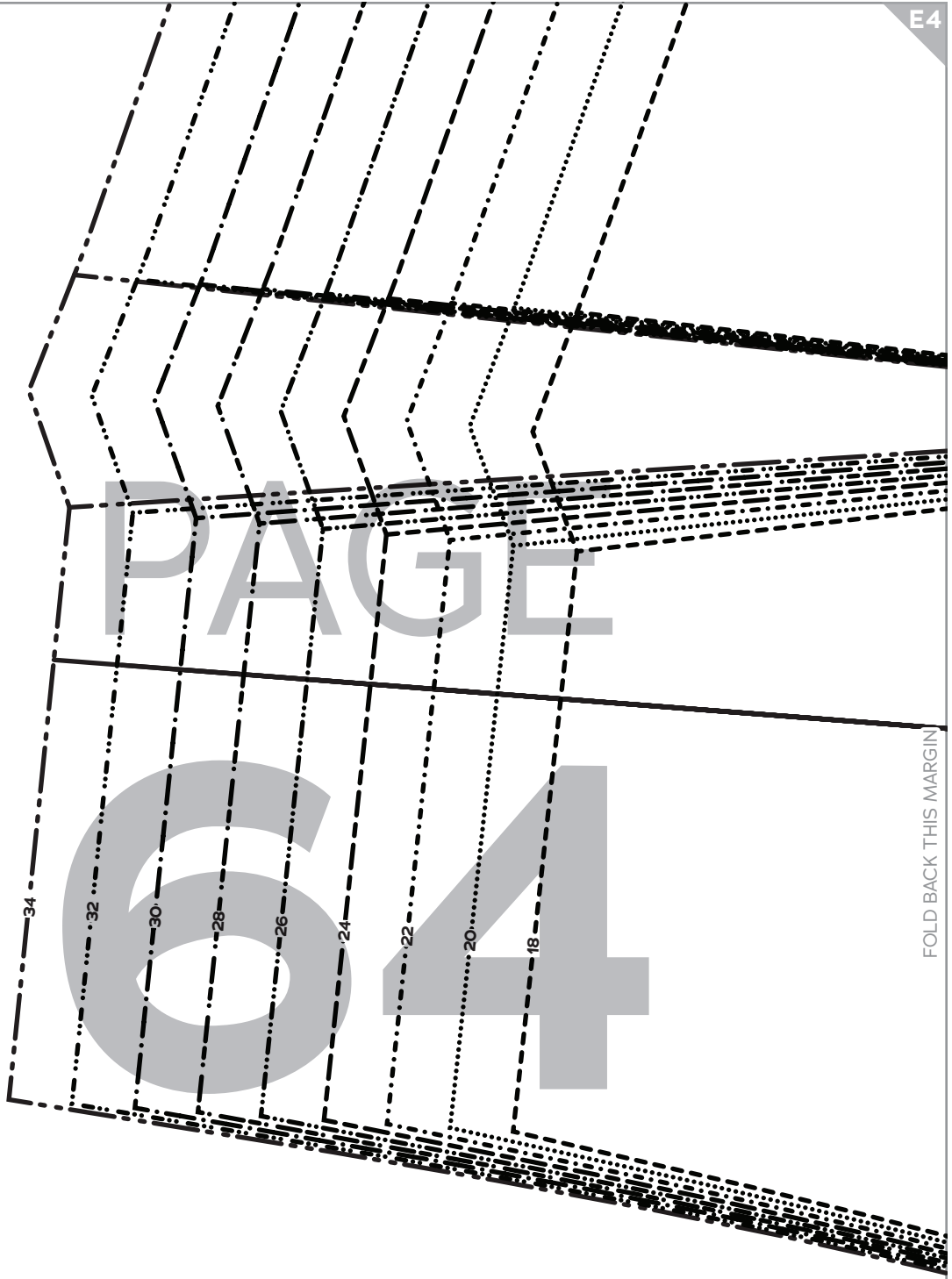

FOLD BACK THIS MARGIN

F3

FOLD BACK THIS MARGIN

F4

E4

E5



PAGE

65

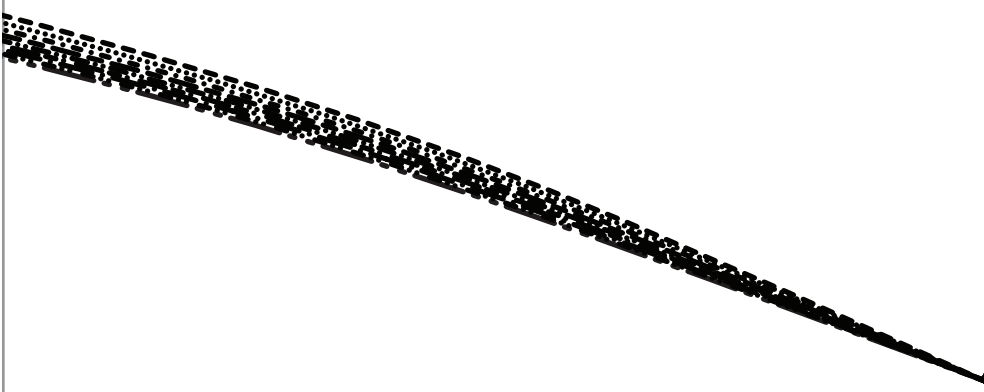

GRAINLINE

LENGTHEN/SHORTEN LINE

FOLD BACK THIS MARGIN

F4

FOLD BACK THIS MARGIN

F5

E5

E6

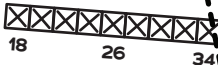

PAGE

66

FOLD BACK THIS MARGIN

F5

FOLD BACK THIS MARGIN

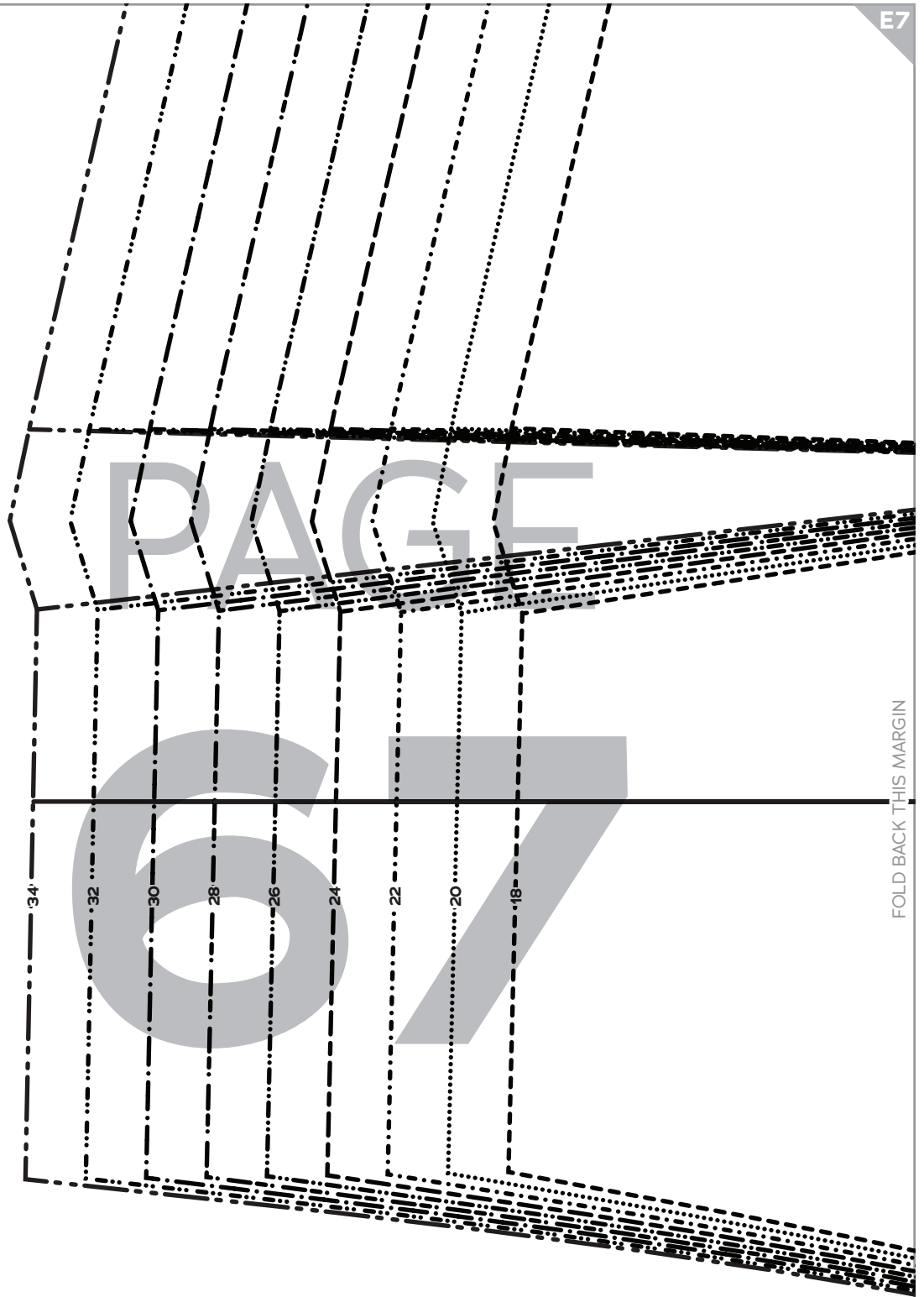

FOLD BACK THIS MARGIN

E7

E8

GRAINLINE

PAGE

LENGTHEN/SHORTEN LINE

68



FOLD BACK THIS MARGIN

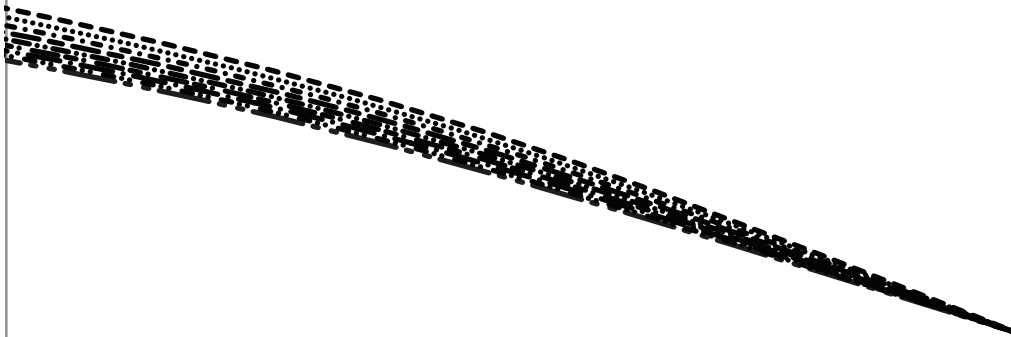
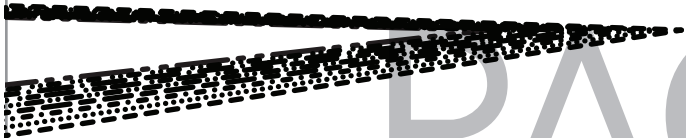

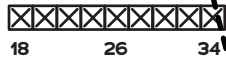

PAGE

69

FOLD BACK THIS MARGIN

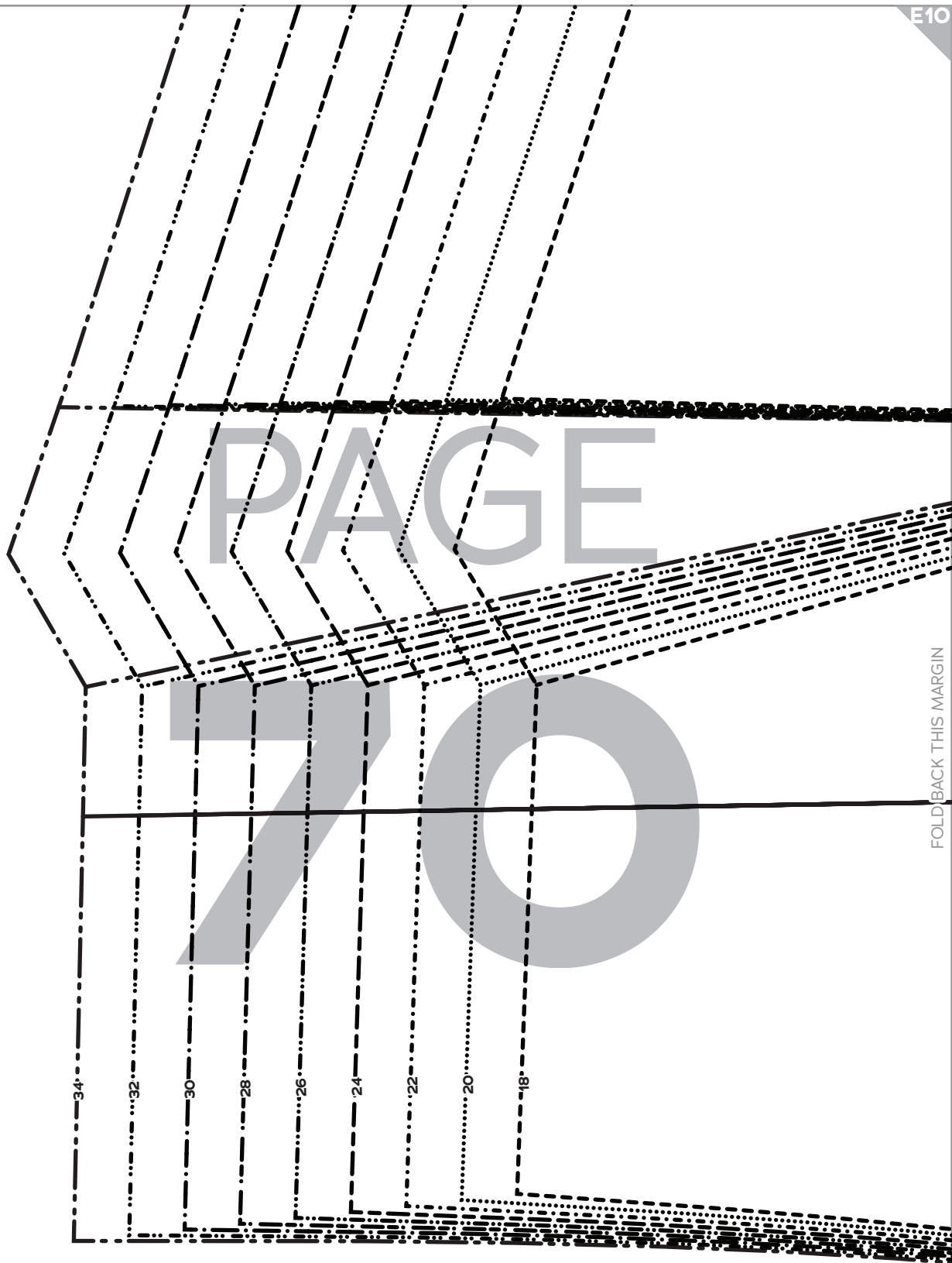

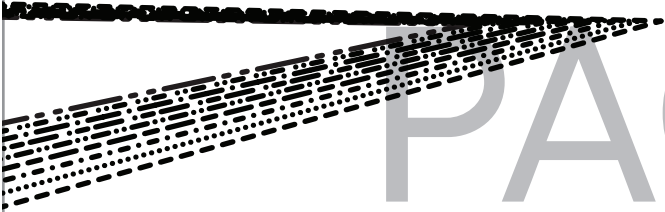

PAGE

71

GRAINLINE

LENGTHEN/SHORTEN LINE



FOLD BACK THIS MARGIN

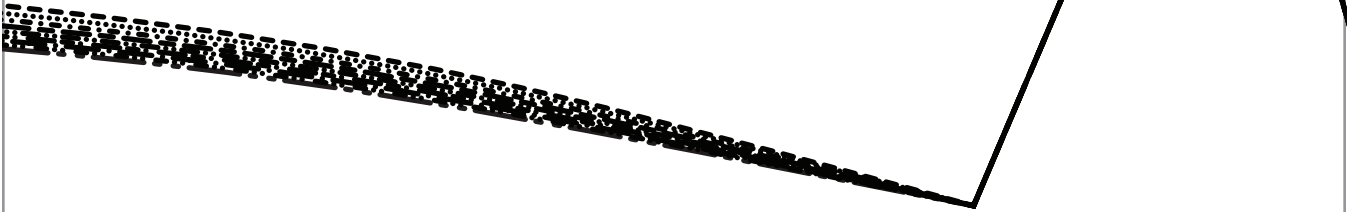

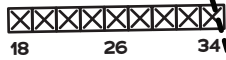
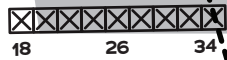
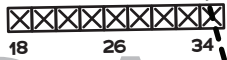
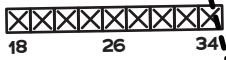

PAGE
72

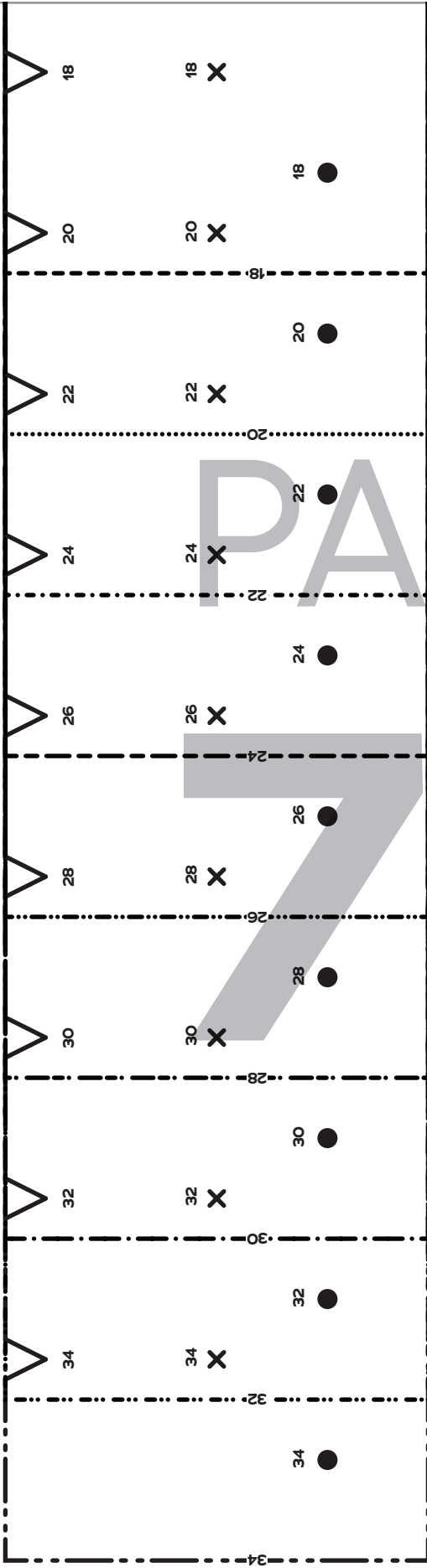

PAGE 3

FOLD BACK THIS MARGIN

FOLD BACK THIS MARGIN

F1

F2

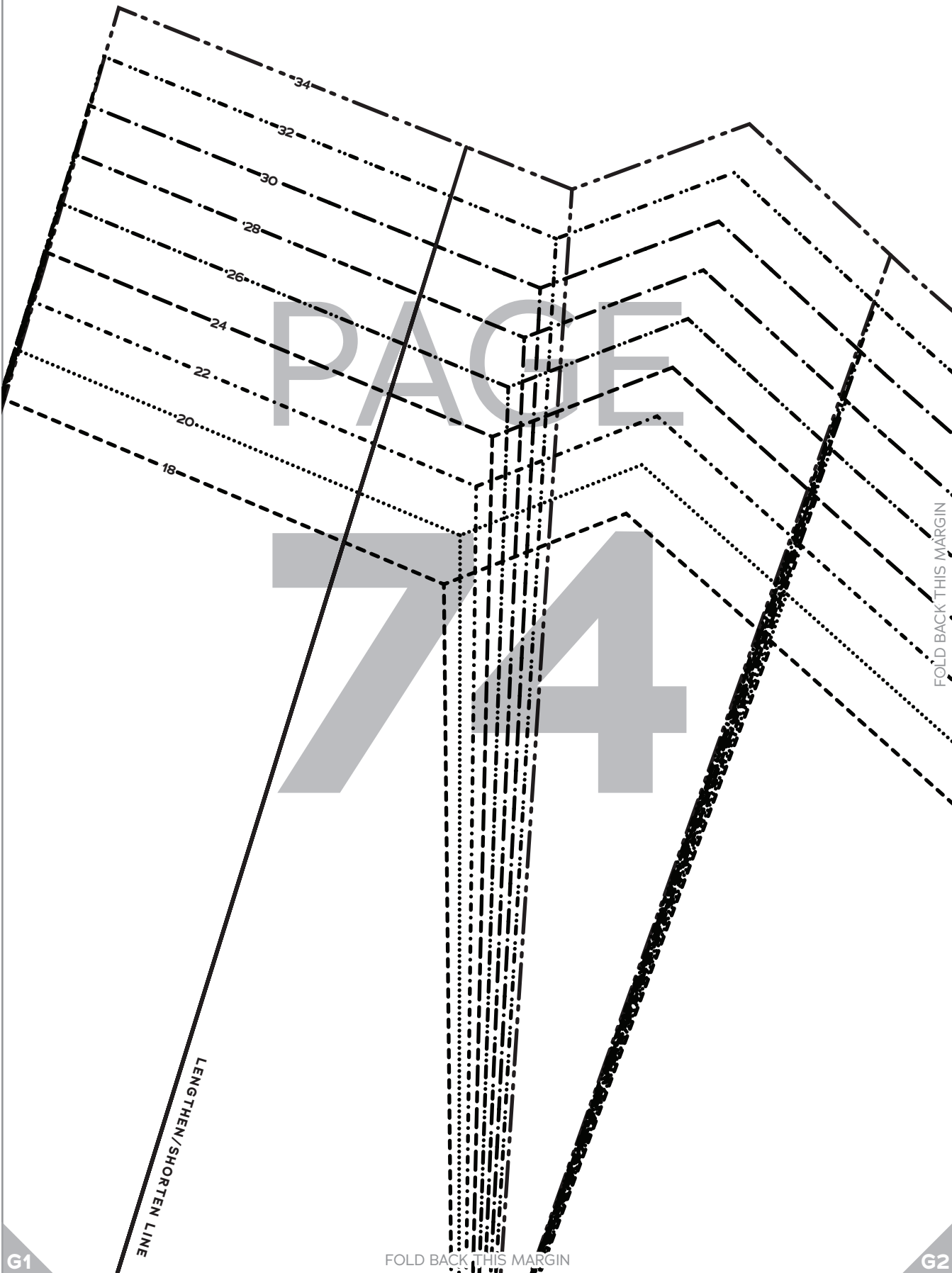

F2

F3

PAGE

75

FOLD BACK THIS MARGIN

G2

FOLD BACK THIS MARGIN

G3

F3

F4

PAGE 76

FOLD BACK THIS MARGIN

G3

FOLD BACK THIS MARGIN

G4

F4

F5

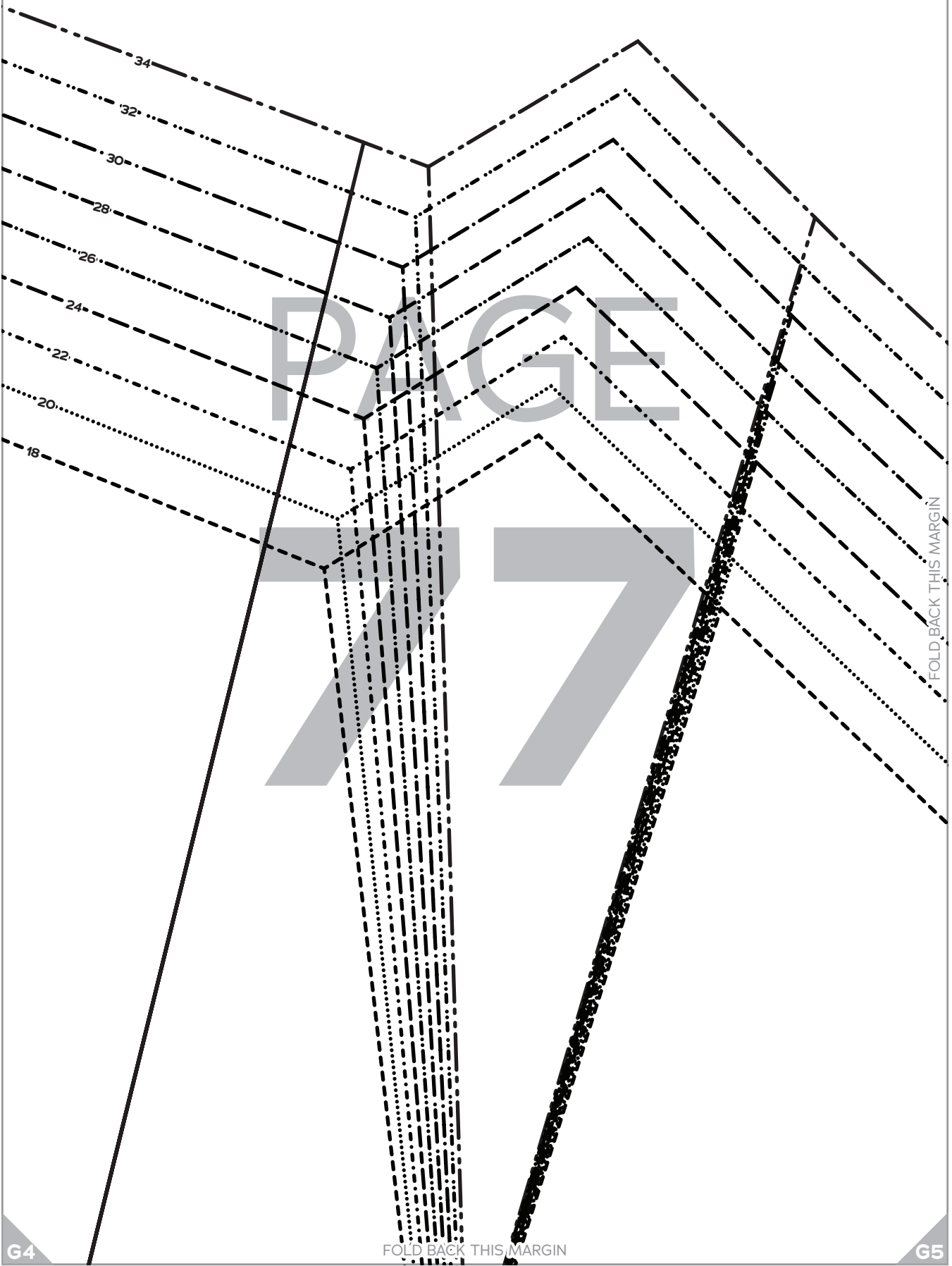

G4

FOLD BACK THIS MARGIN

G5

F5

PAGE

78

G5

FOLD BACK THIS MARGIN

PAGE

79

FOLD BACK THIS MARGIN

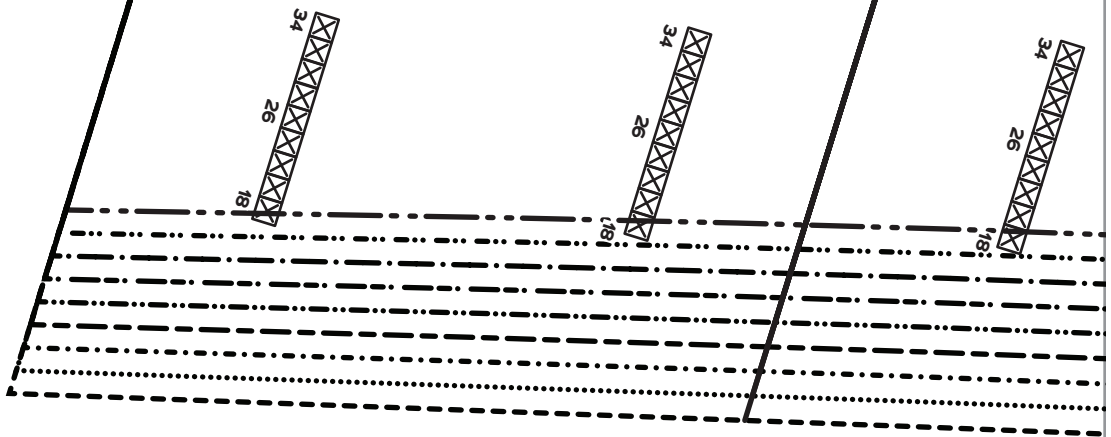

G1

G2

PAGE

80

GRAINLINE

FOLD BACK THIS MARGIN



CHARM SCHOOL
UNIFORM
SIZES 18-34

Bodice Front,
F/G Cup
Cut 2 fabric, 2 lining

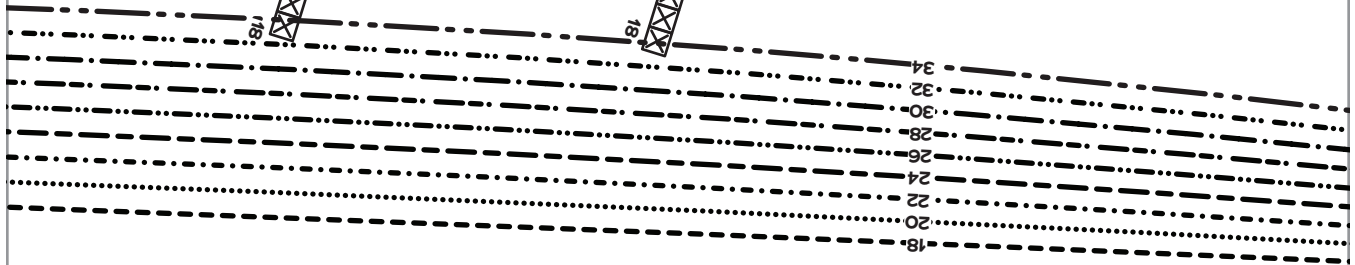
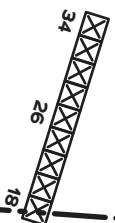
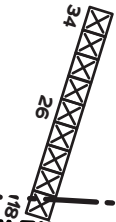

G2

G3

PAGE

81

FOLD BACK THIS MARGIN

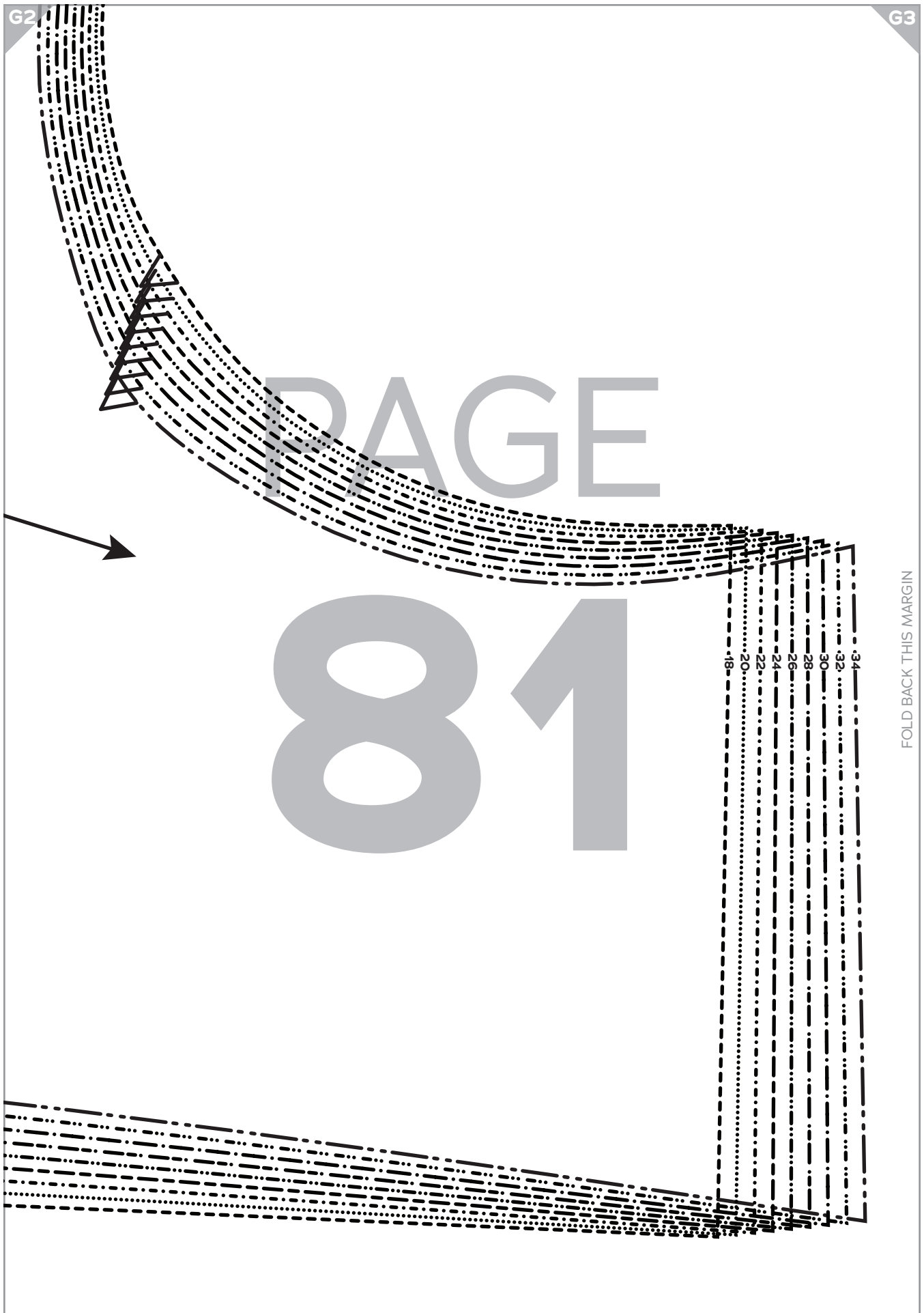

PAGE

82

FOLD BACK THIS MARGIN

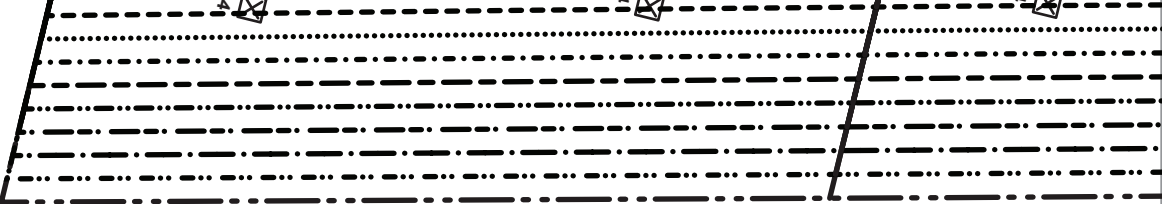
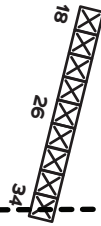
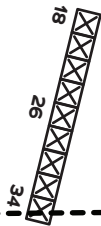
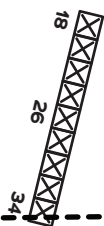

G4

G5

LENGTHEN/
SHORTEN LINE

PAGE

GRAINLINE

83

CHARM SCHOOL
UNIFORM
SIZES 18-34
Bodice Front,
H Cup
Cut 2 fabric, 2 lining



FOLD BACK THIS MARGIN

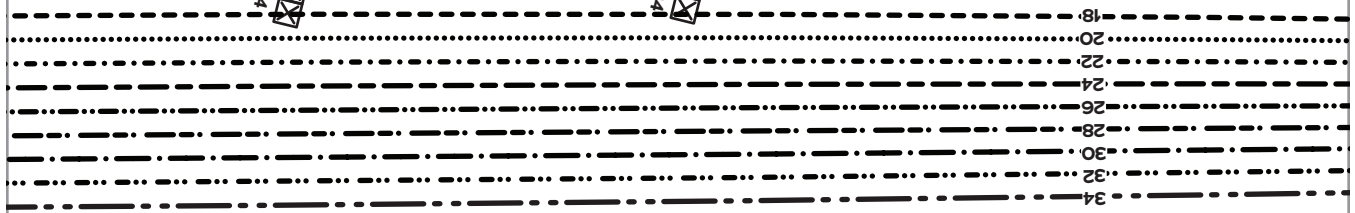
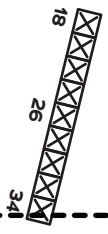
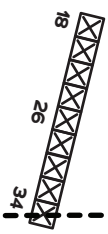

G5

PAGE

84



34
32
30
28
26
24
22
20
18

