



FRENCHY PEIGNOIR SET

Sizes 2-20 with cup sizes A-H

5/8 inch (in) (1.5 cm) seam allowances are included on all pattern pieces.

© 2022 Charm Patterns by Gertie.
Distribution and Commercial Use Prohibited.

SYMBOL KEY

grainline arrow



match point/
placement mark



1" test
square

SIZES 2-20 PATTERN SIZE KEY

2	—————
4	- - - - -
6
8	- . - . -
10	— · — · —
12	- · - · -
14
16	- · - · -
18	- - - - -
20

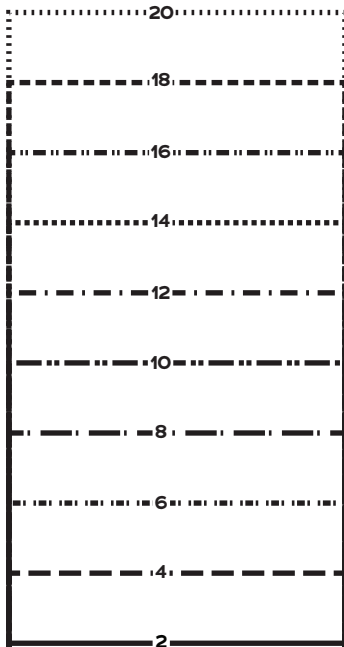

FRENCHY
PEIGNOIR
SET
SIZES 2-20

A 5



Cut apart any pattern pieces that share a page by cutting on the gray long dashed lines. Then fold back the page margins on each page as directed.

Tape the pages together, butting up the folded page edges with the gray margin lines, matching up the letters in gray boxes.

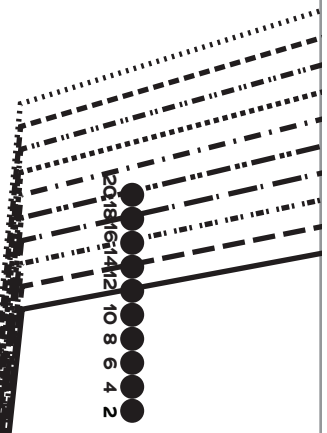

D 10

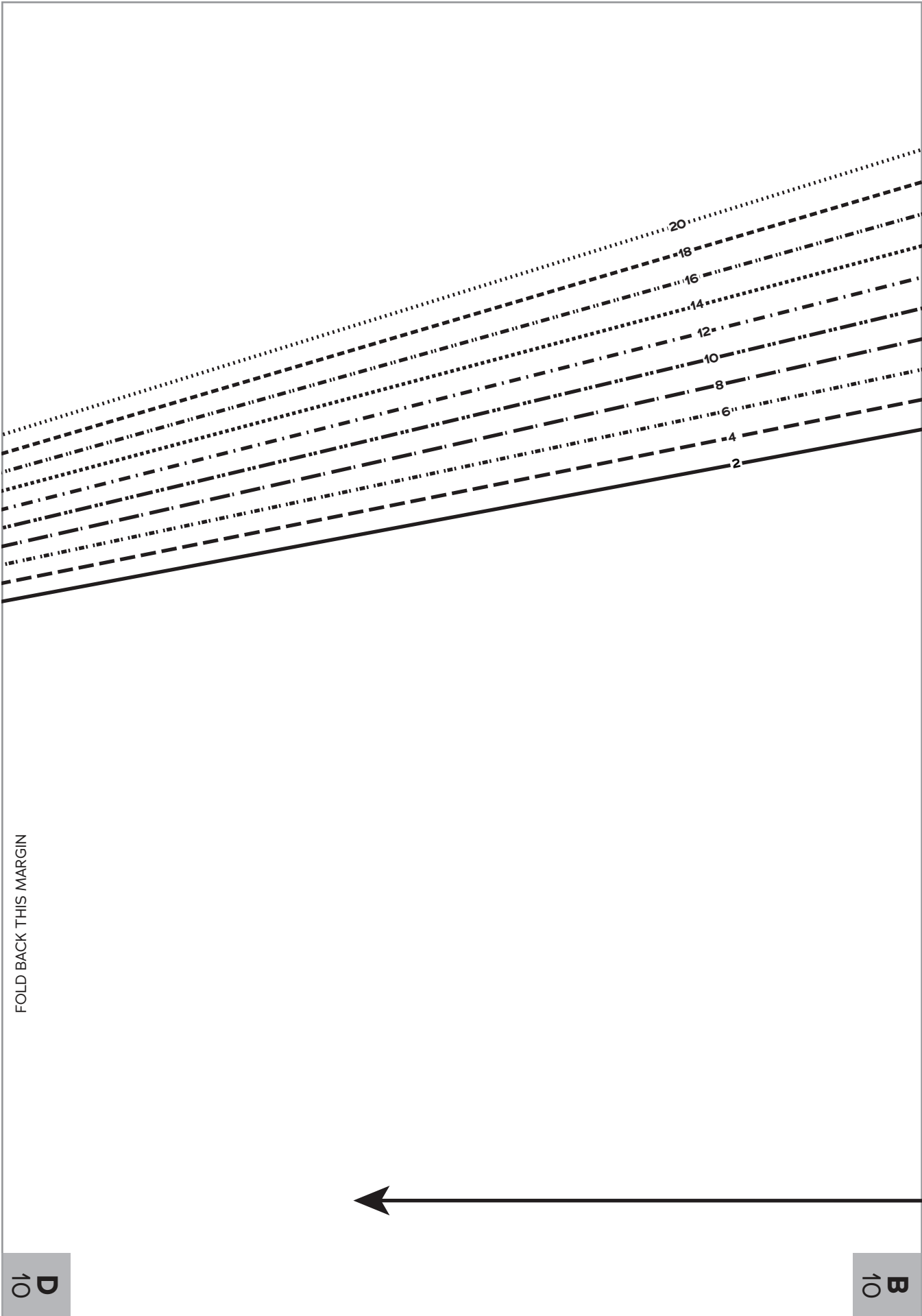

FOLD BACK THIS MARGIN

D
10

B
10

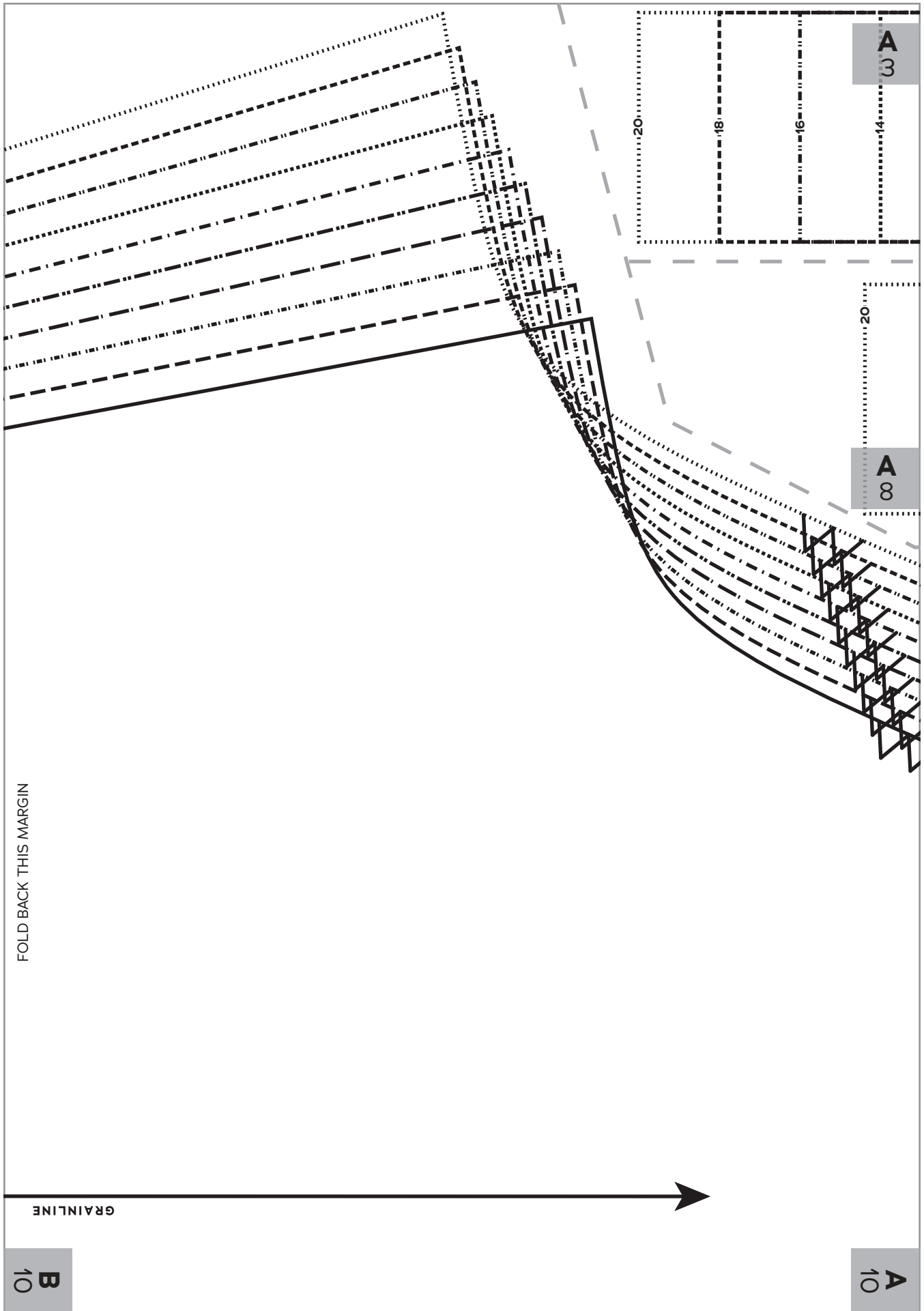

FOLD BACK THIS MARGIN

GRAINLINE

A
3

A
8

B
10

A
10

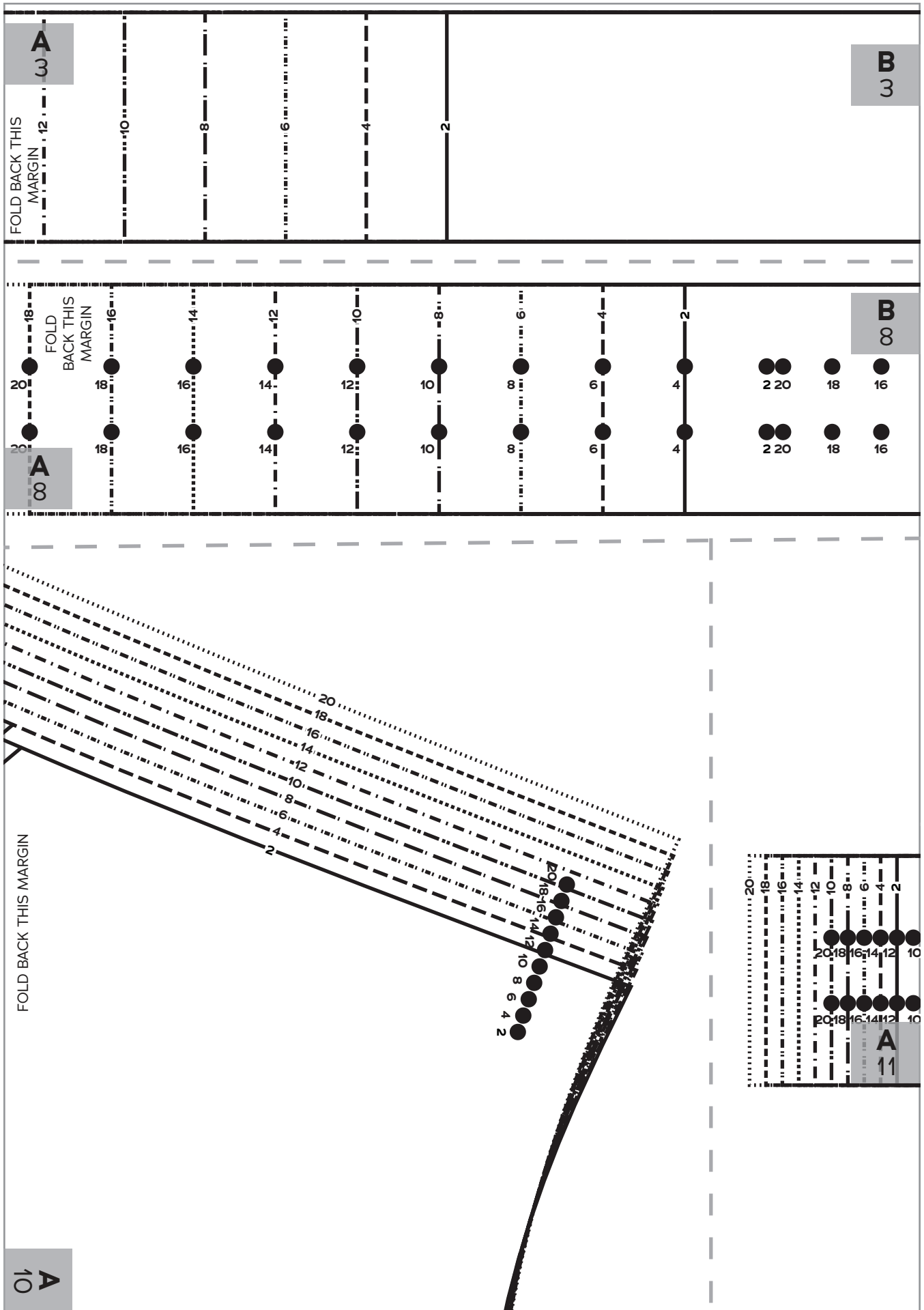

B
3

FOLD BACK THIS MARGIN

● 20 ● 18 ● 16 ● 14 ● 12 ● 10 ● 8 ● 6 ● 4 ● 2

● 20 ● 18 ● 16 ● 14 ● 12 ● 10 ● 8 ● 6 ● 4 ● 2

C
3

B
8

● 14 ● 12 ● 10 ● 8 ● 6 ● 4 ● 2

● 14 ● 12 ● 10 ● 8 ● 6 ● 4 ● 2

FOLD BACK THIS MARGIN

8

Robe Neck Bias Binding

Cut 1 fabric

● 20 ● 18

● 20 ● 18

C
8

● 20 ● 18 ● 16 ● 14 ● 12 ● 10 ● 8 ● 6 ● 4 ● 2

A
12

FOLD BACK THIS MARGIN

● 8 ● 6 ● 4 ● 2

● 8 ● 6 ● 4 ● 2

A
11

CHARM ARTIST COLLECTIVE

FRENCHY PEIGNOIR SET

SIZES 2-20

B
11

C
3

FOLD BACK THIS MARGIN



FRENCHY PEIGNOIR SET
SIZES 2-20

3

Nightie Neck Bias Binding

Cut 1 fabric

D
3

C
8



FOLD BACK THIS MARGIN



FRENCHY PEIGNOIR SET
SIZES 2-20

V

D
8

A
12

FOLD BACK THIS MARGIN



FRENCHY PEIGNOIR SET
SIZES 2-20

12

Robe Armhole Binding

Cut 2 fabric

B
12



B
11

FOLD BACK THIS MARGIN

11

Robe Sleeve Hem Bias Binding

Cut 2 fabric

GRAINLINE

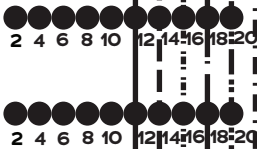
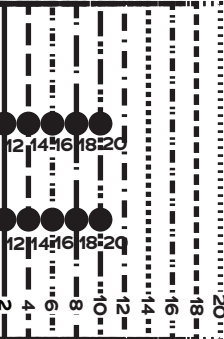

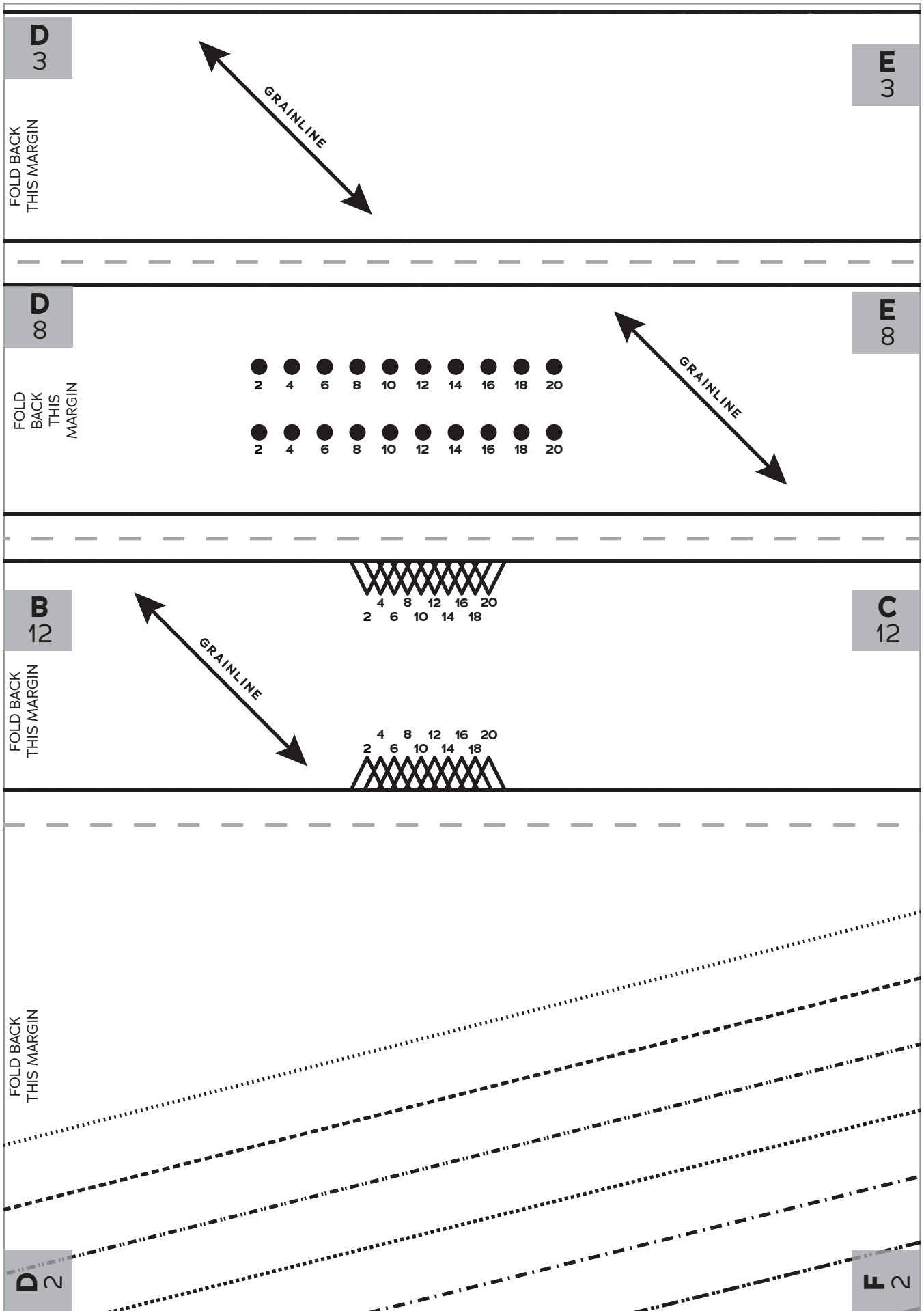

D
2

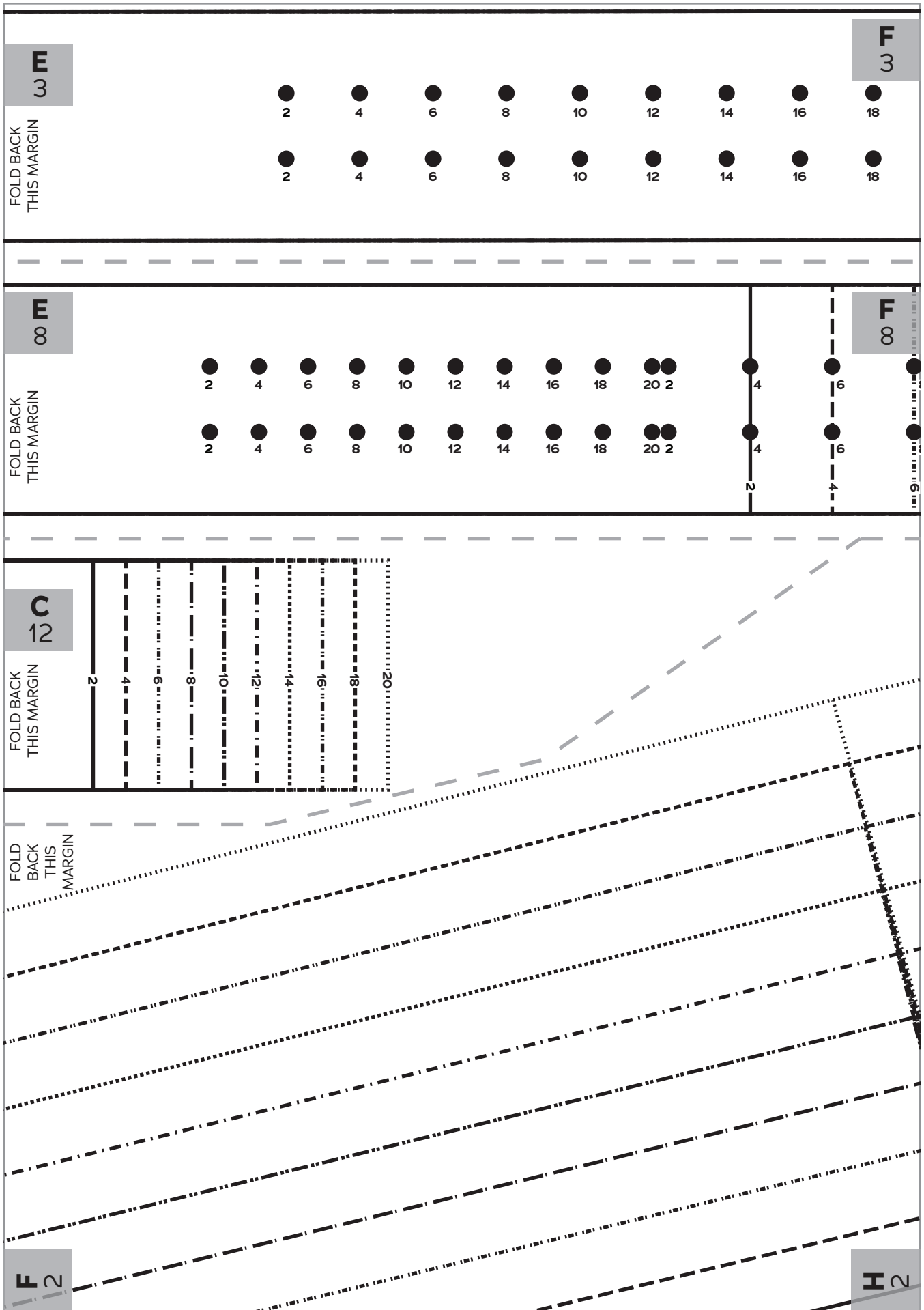

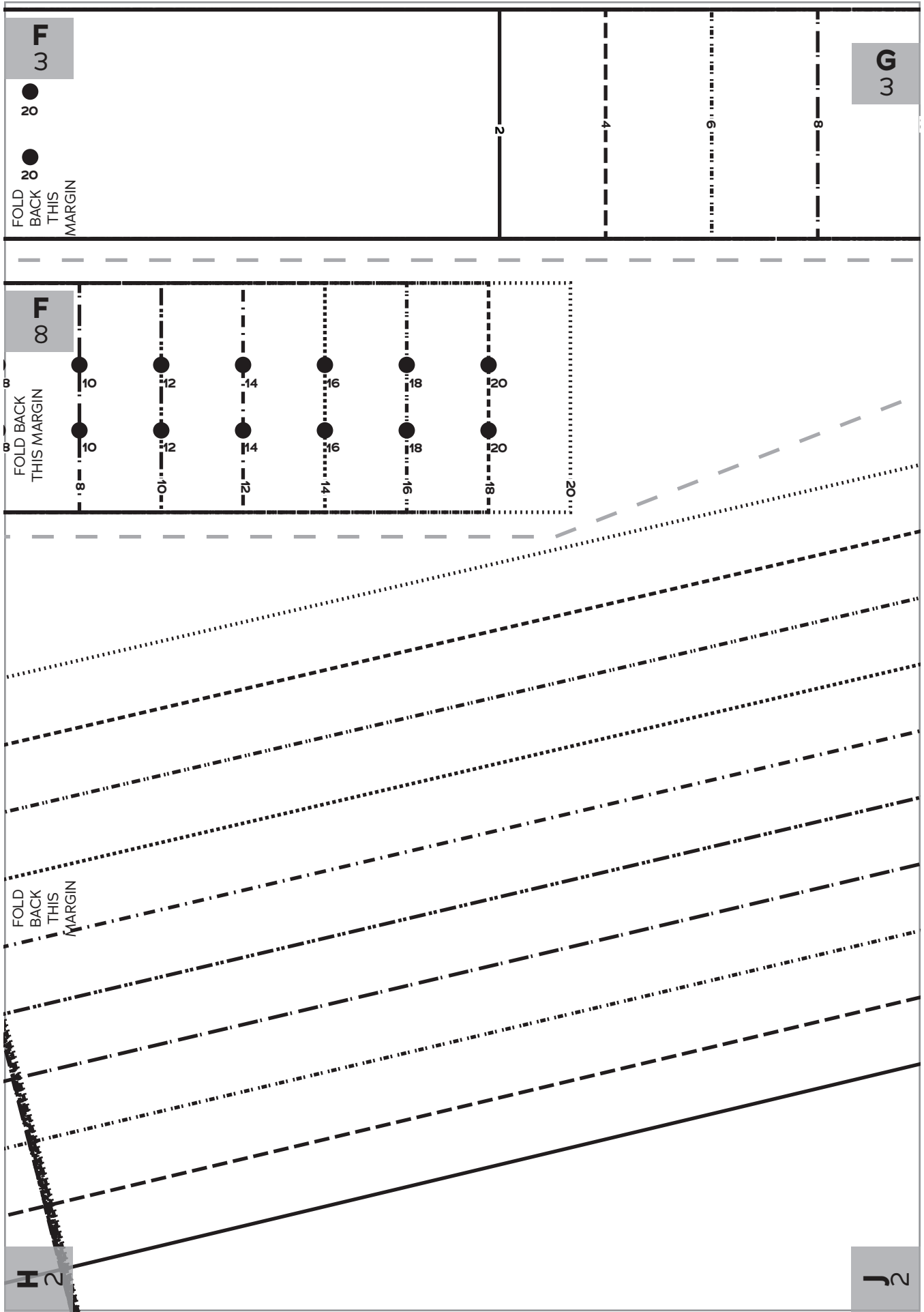

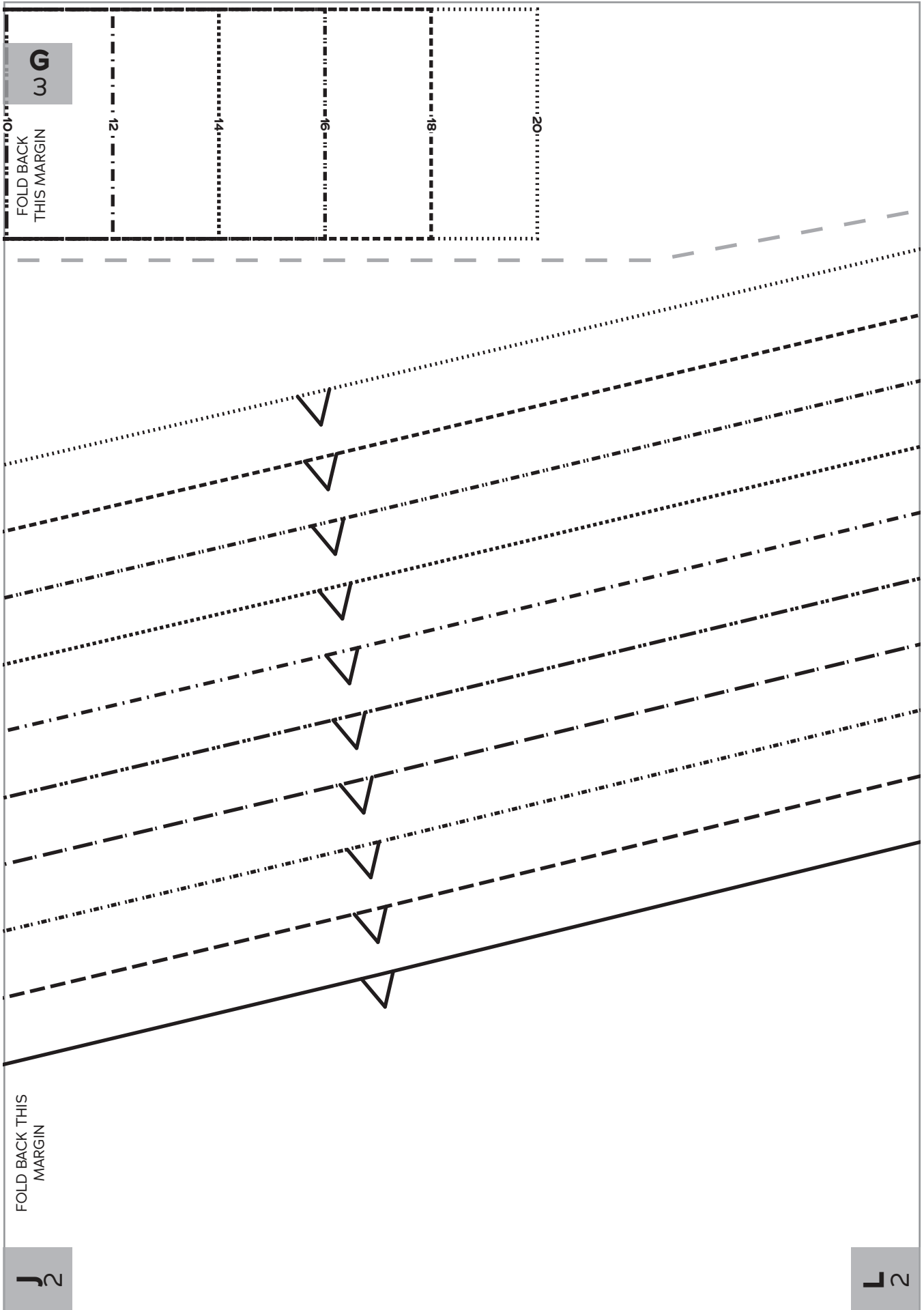



3

FOLD BACK THIS MARGIN

12

14

16

18

20

FOLD BACK THIS MARGIN

2

2

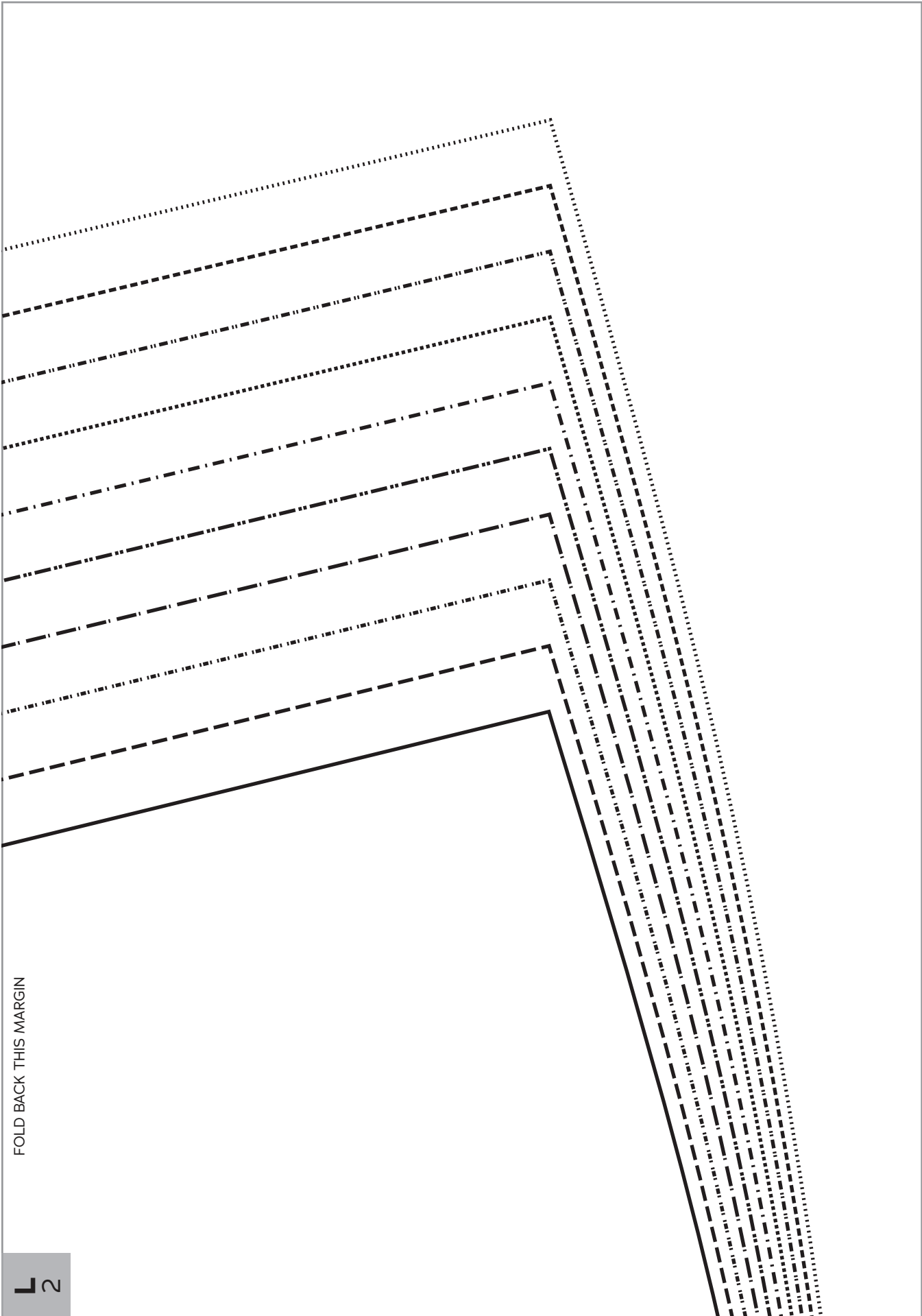

FOLD BACK THIS MARGIN

L 2

D
10

FOLD BACK
THIS MARGIN



2 4 6 8 10 12 14 16 18 20

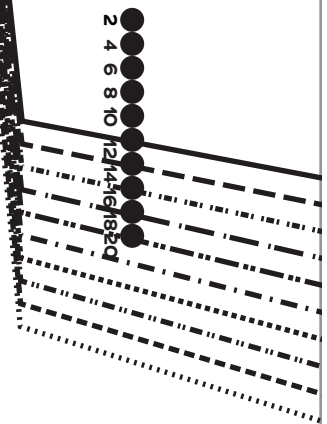

A
5

FOLD BACK
THIS MARGIN

5

Nightie
Armhole Binding

Cut 2 fabric

2 4 6 8 10 12 14 16 18 20

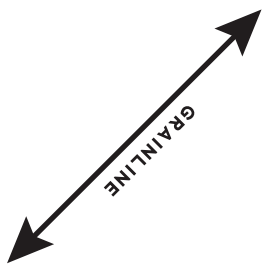
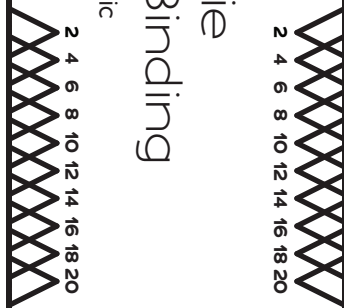

2

4

6

8

10

12

14

16

18

20

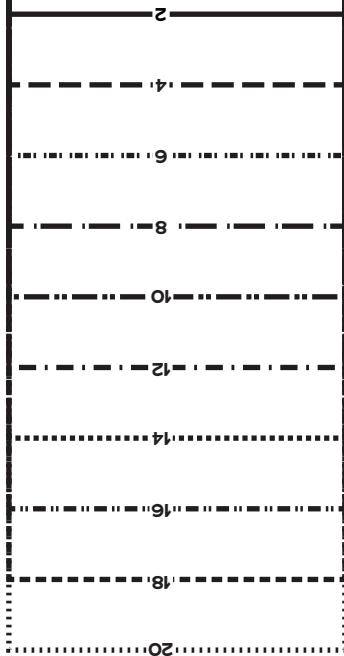

B
10

Rope
Sleeve
Lining
Cut 2 fabric

FOLD BACK THIS MARGIN

D
10

FOLD BACK THIS MARGIN

C
10

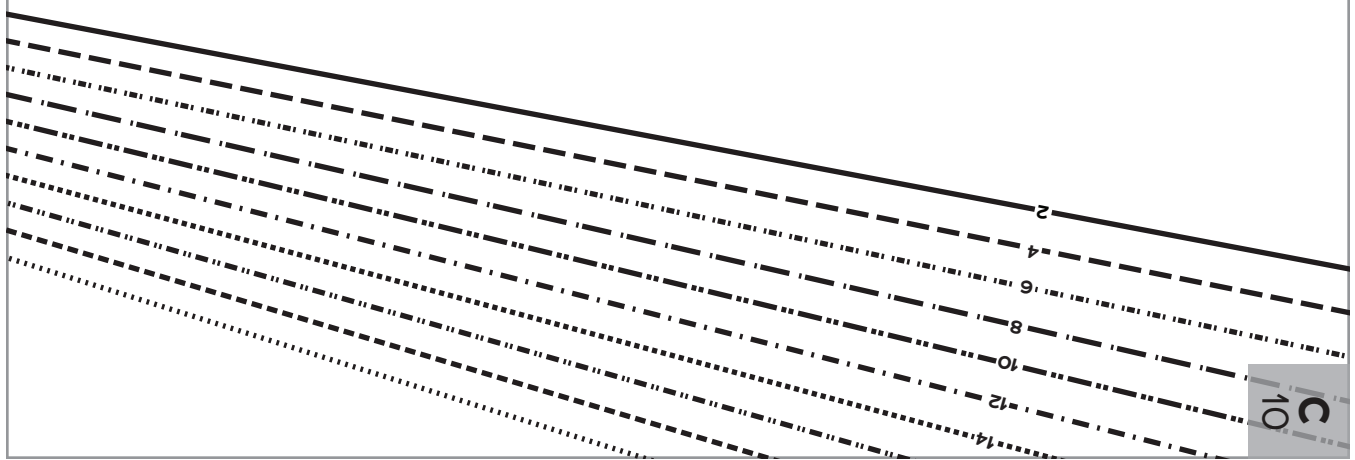

A
10

FOLD BACK THIS MARGIN



**FRENCHY
PEIGNOIR
SET**

SIZES 2-20

B
10

10

FOLD BACK THIS MARGIN



C
10

FOLD BACK THIS MARGIN

FOLD BACK THIS MARGIN

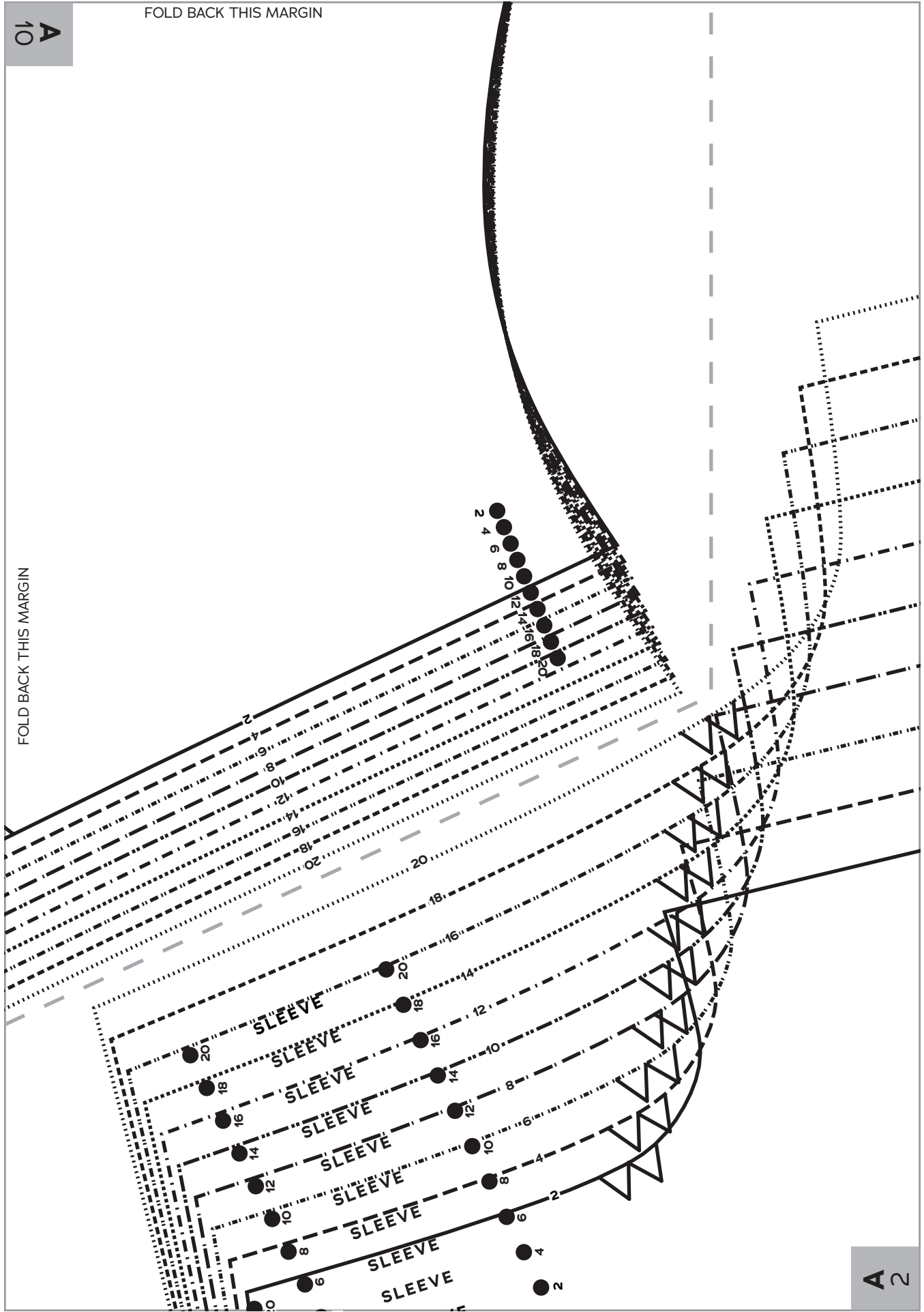

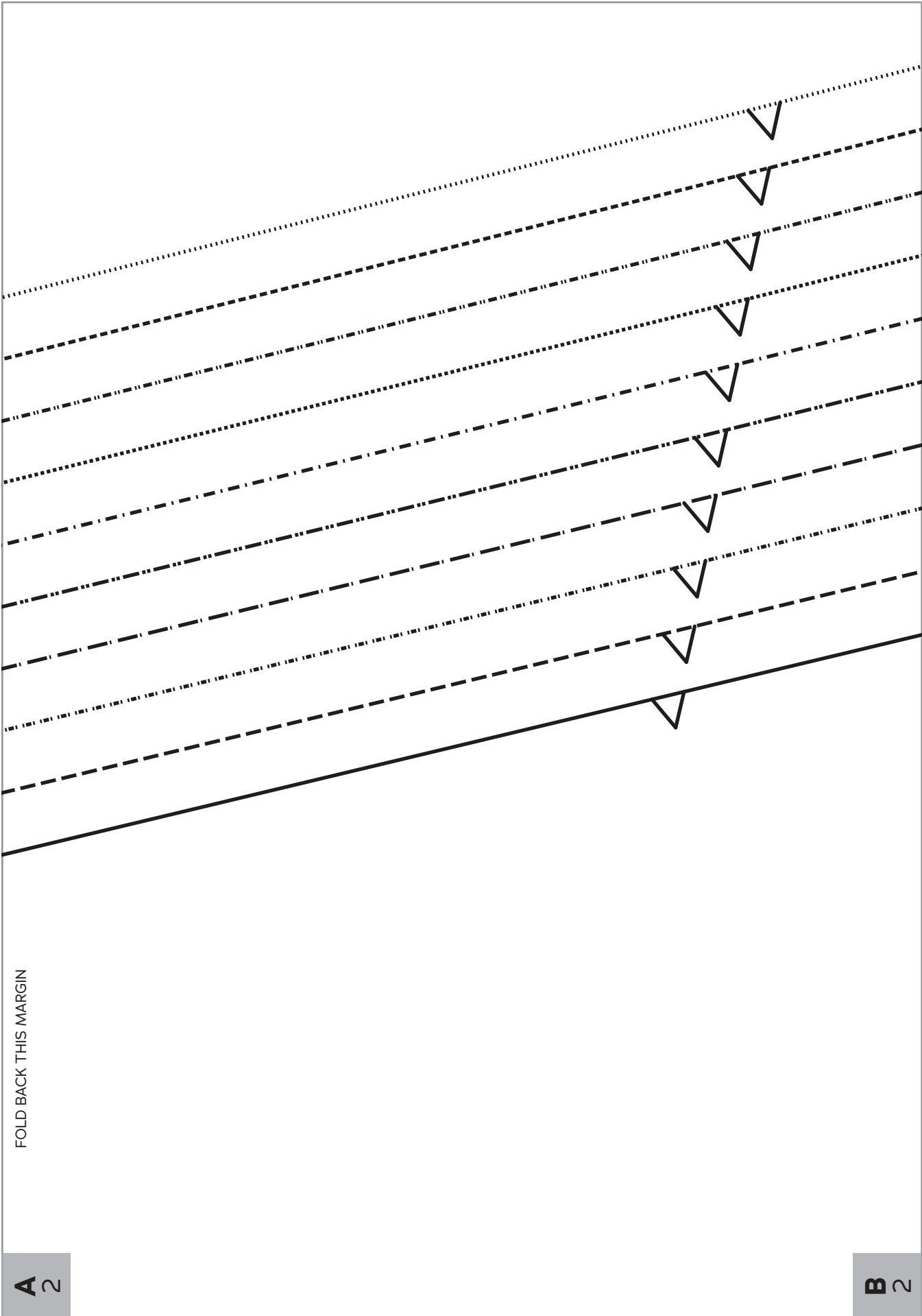

FOLD BACK THIS MARGIN

A 2

B 2

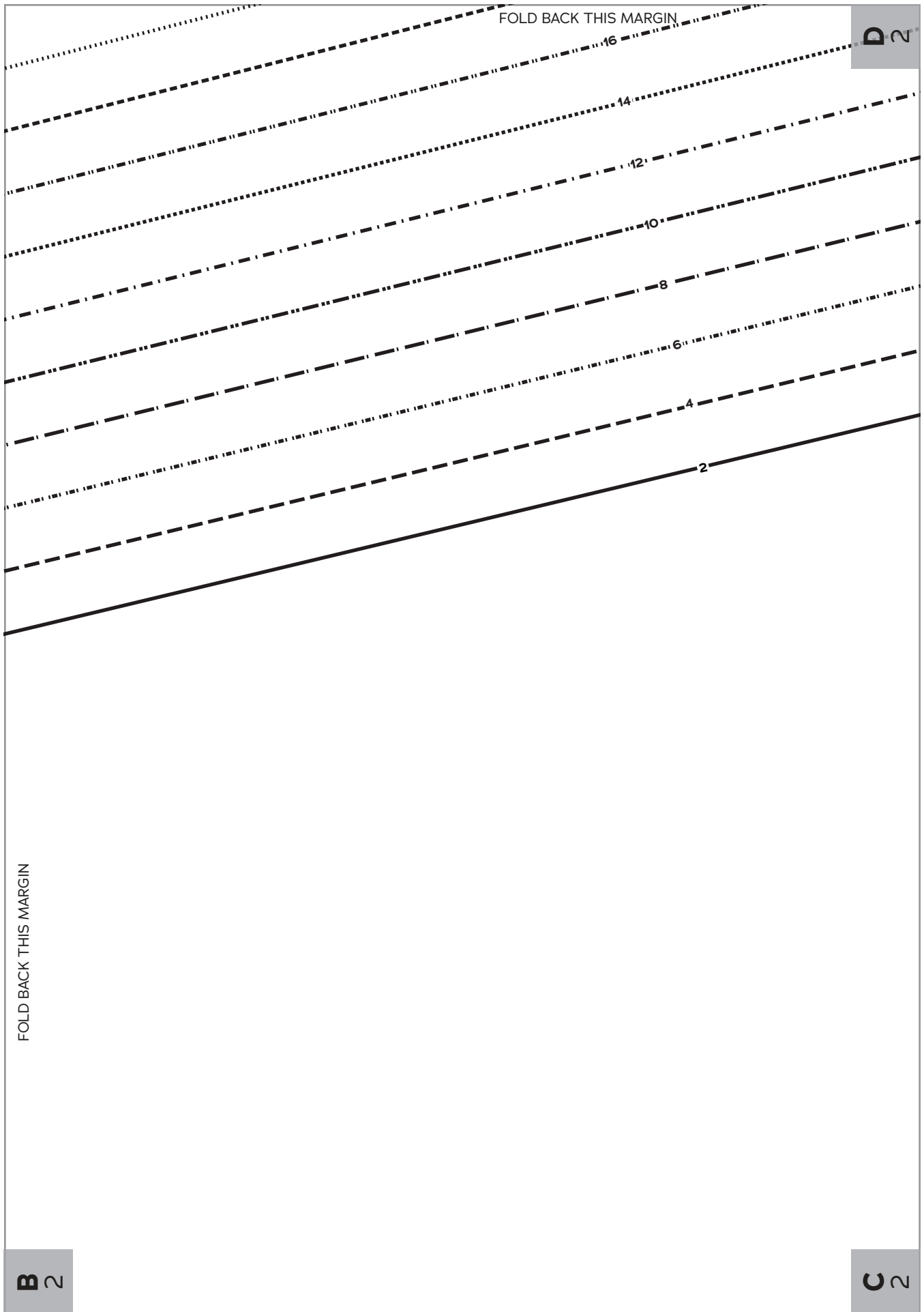

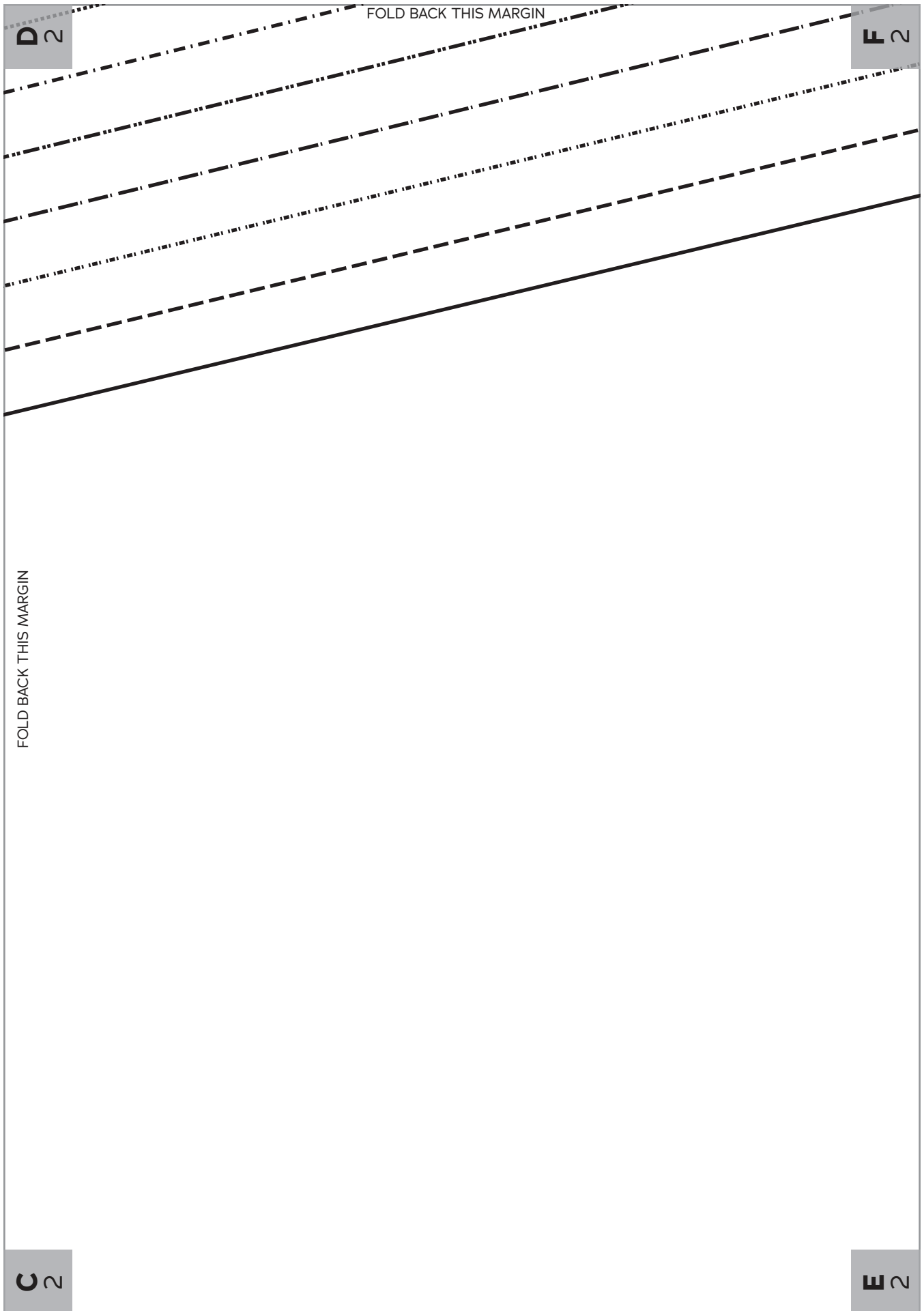

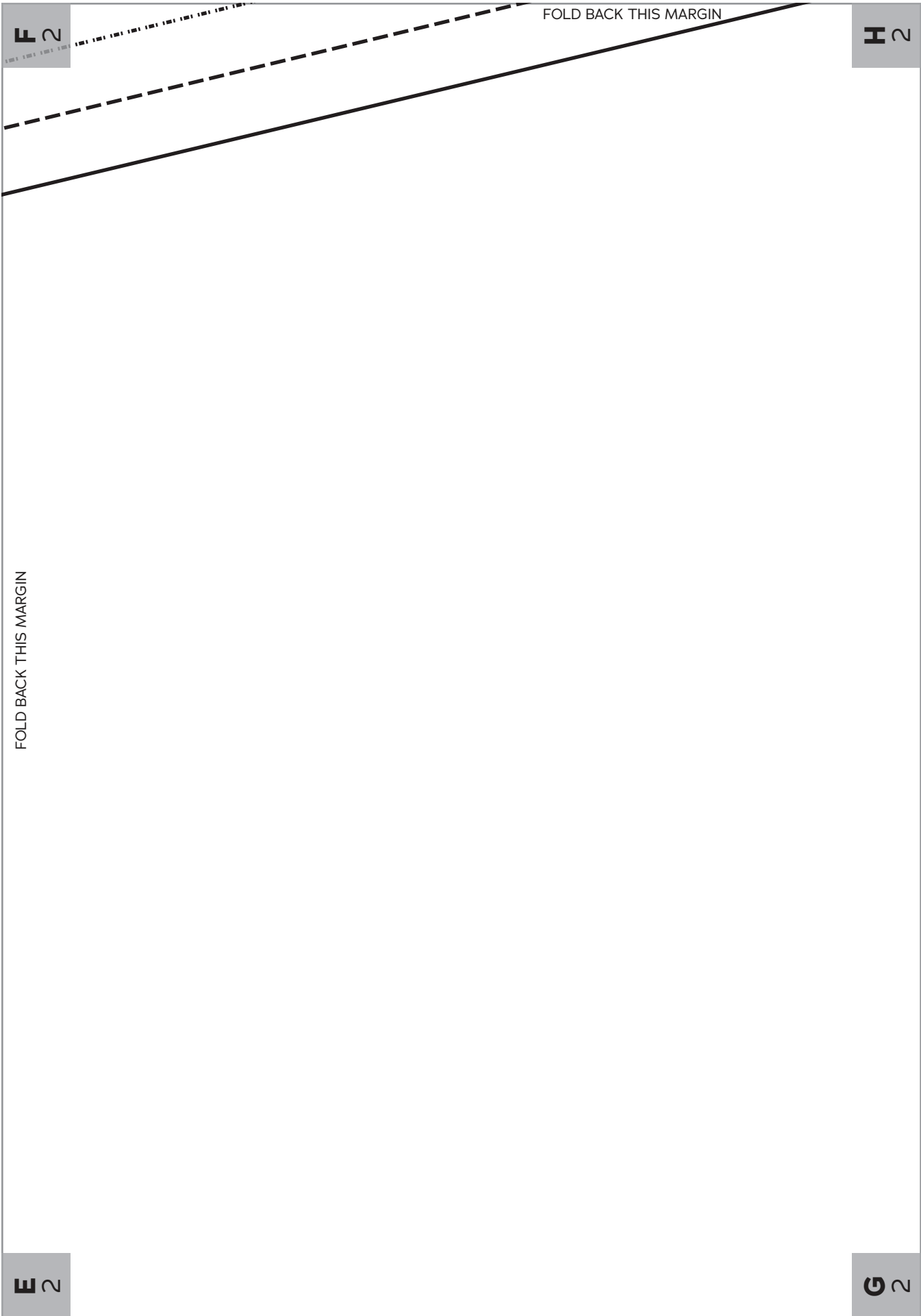

H 2

FOLD BACK THIS MARGIN

J 2

FOLD BACK THIS MARGIN

G 2

I 2

FOLD BACK THIS MARGIN

J 2

L 2

FOLD BACK THIS MARGIN

I 2

K 2

L 2

FOLD BACK THIS MARGIN

FOLD BACK THIS MARGIN

K 2

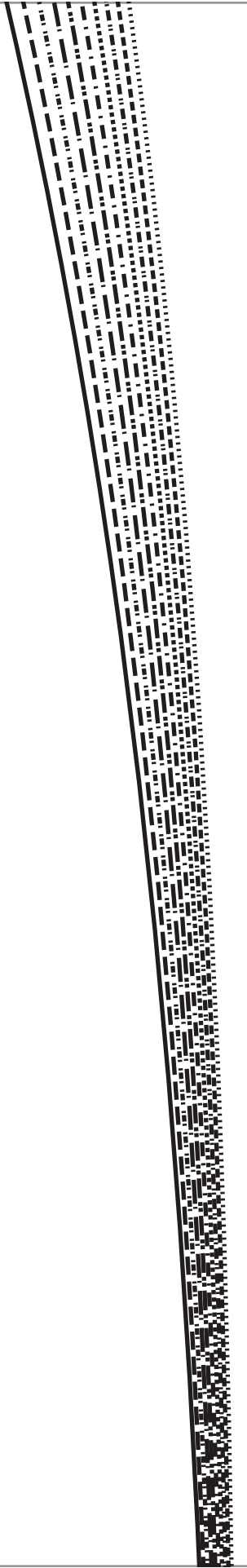

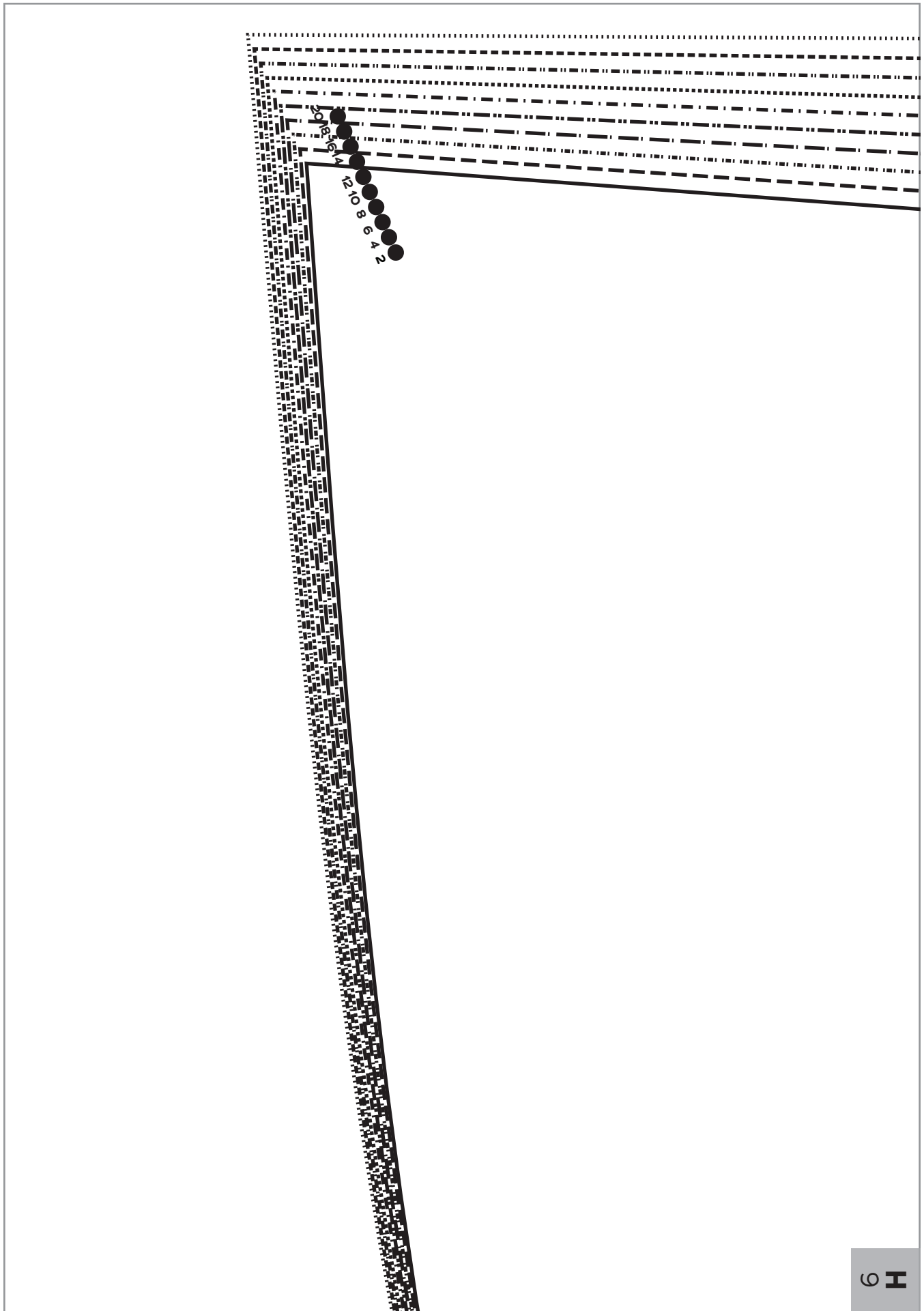

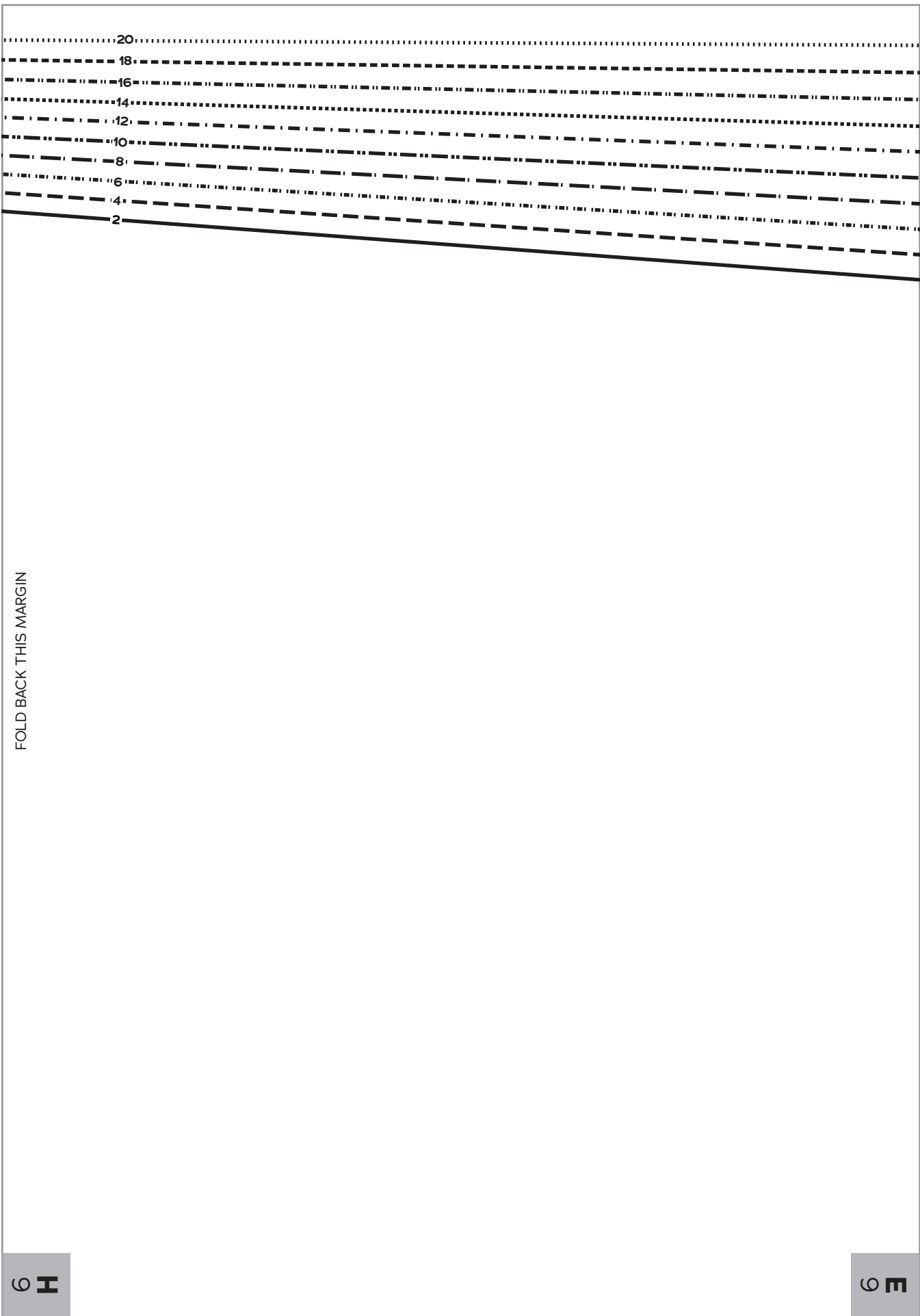

FOLD BACK THIS MARGIN



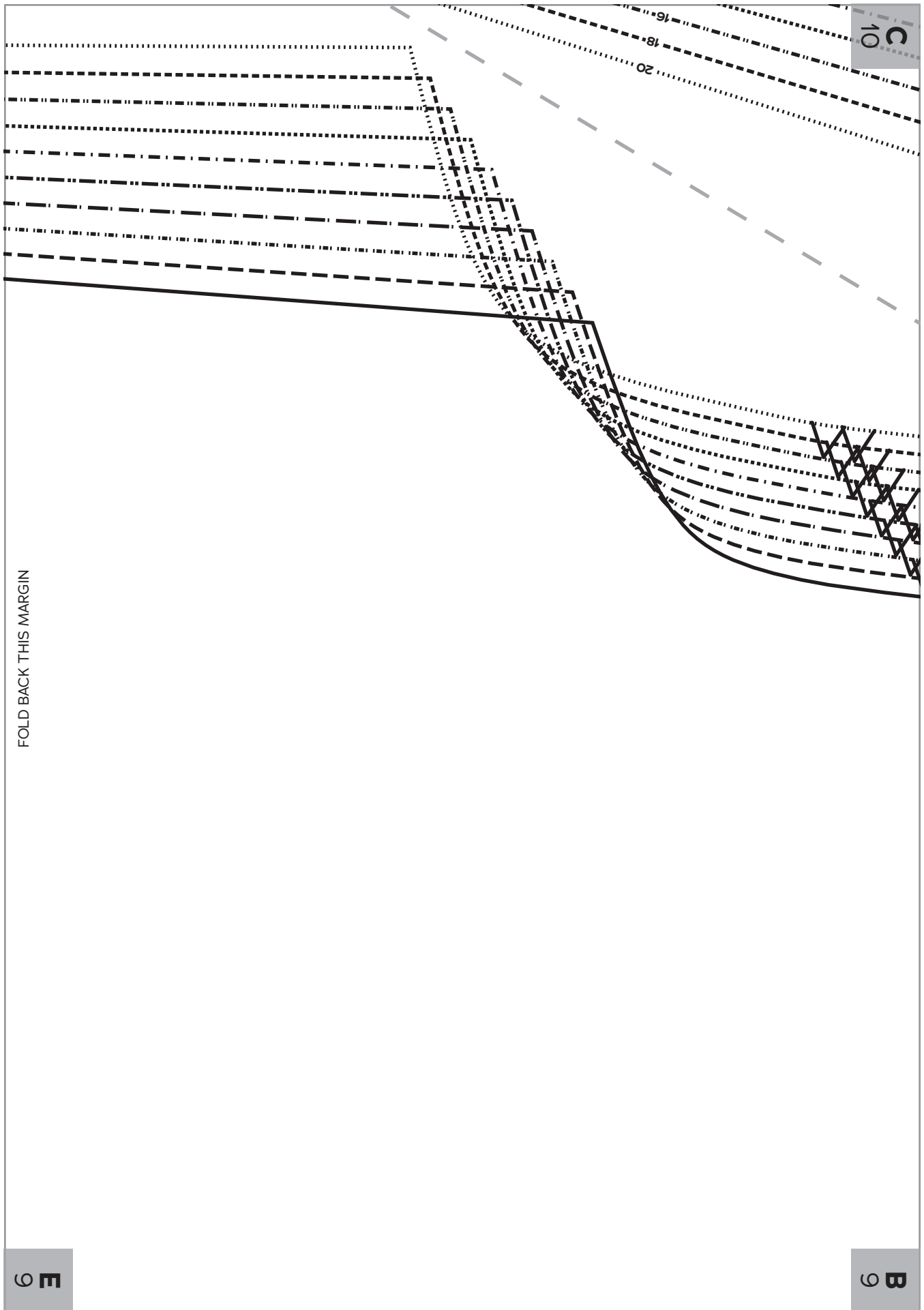

FOLD BACK THIS MARGIN

E

B

C

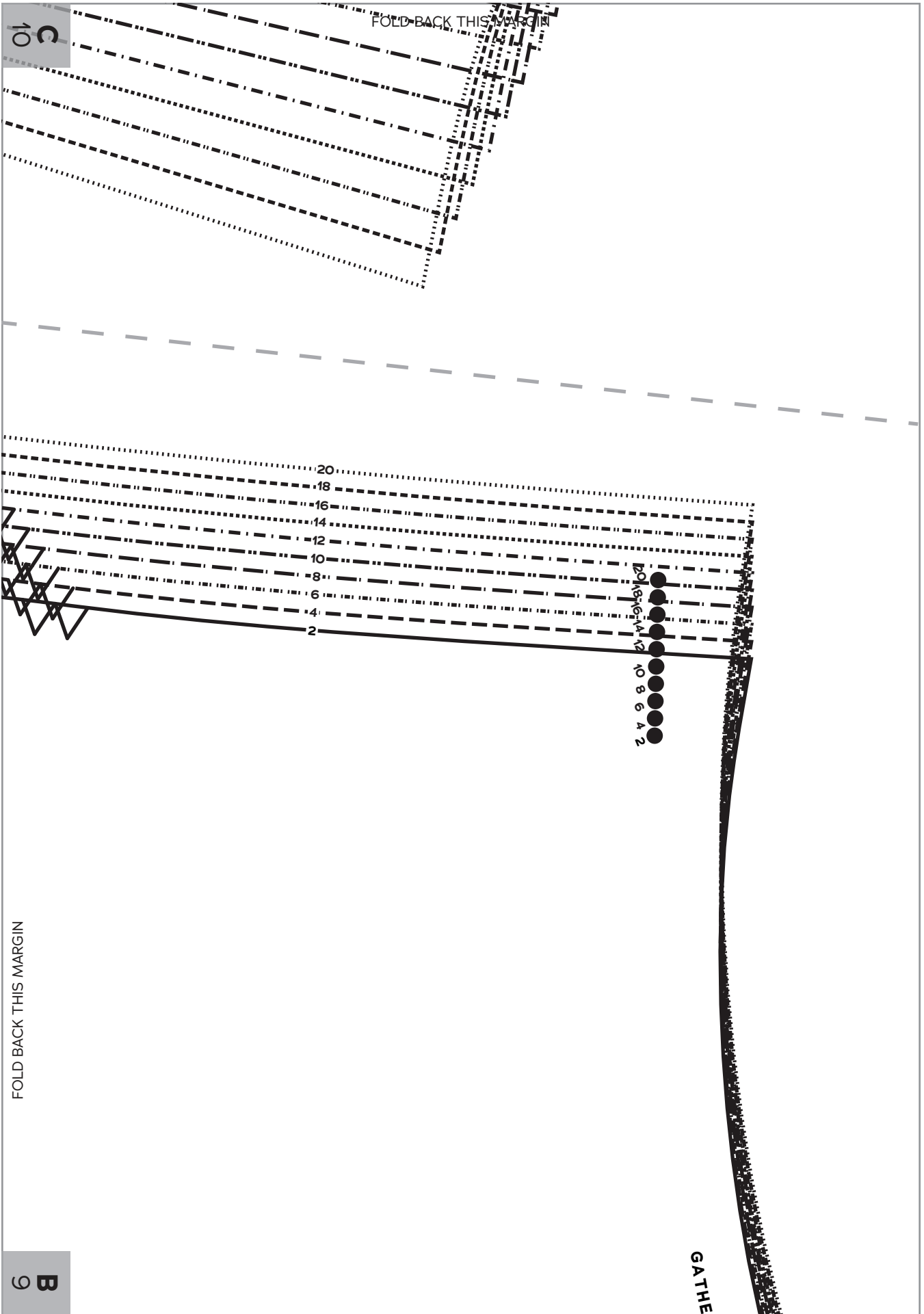

FOLD BACK THIS MARGIN

FOLD BACK THIS MARGIN

C
10

B
9

20
18
16
14
12
10
8
6
4
2

20
18
16
14
12
10
8
6
4
2

GATHE

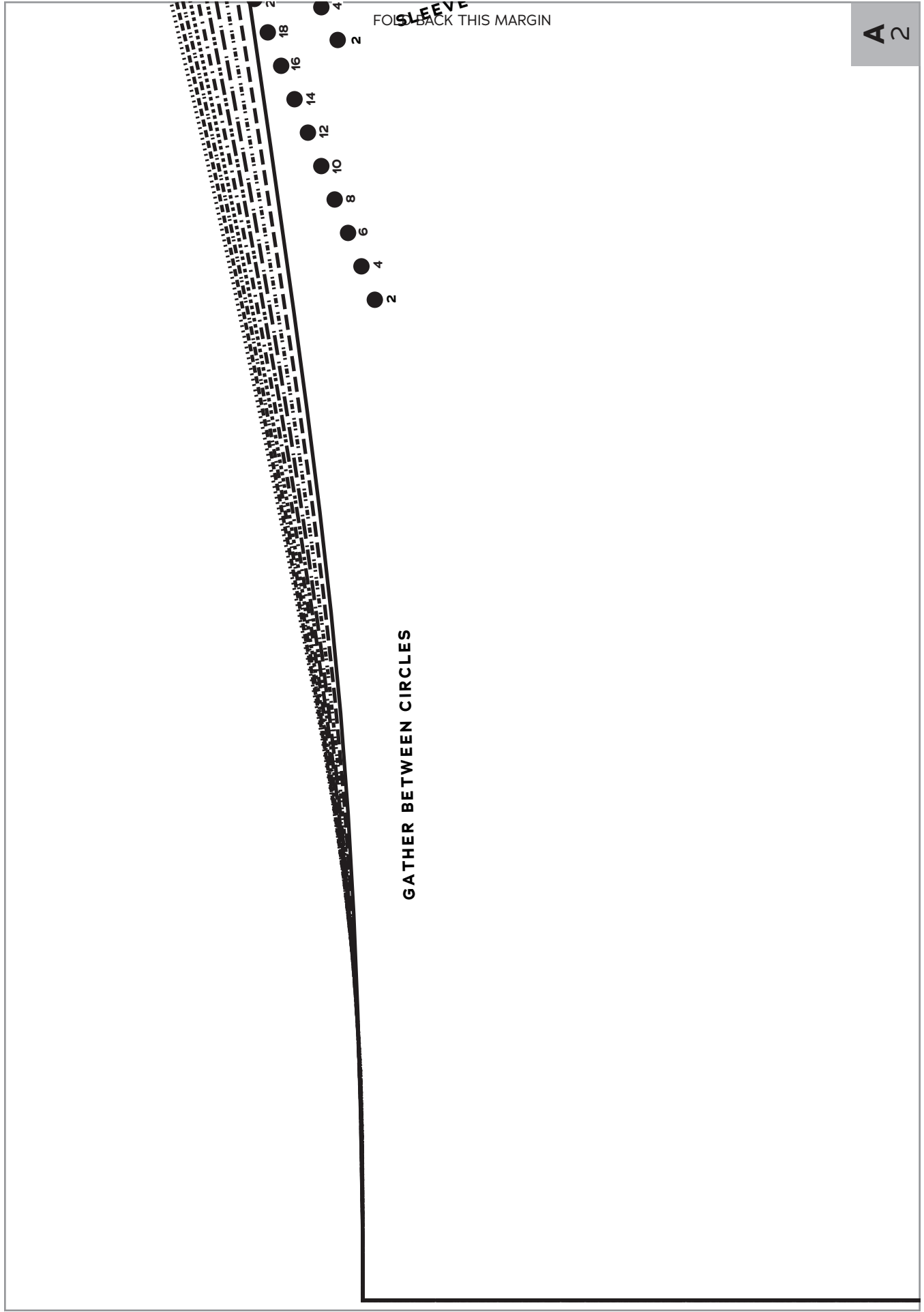

SLEEVE
FOLD BACK THIS MARGIN

A 2

GATHER BETWEEN CIRCLES

A 2

FOLD BACK THIS MARGIN

B 2

FOLD BACK THIS MARGIN

B 2

FOLD BACK THIS MARGIN

C 2

FOLD BACK THIS MARGIN



FOLD BACK THIS MARGIN



**FRENCHY
PEIGNOIR
SET**

SIZES 2-20

2

Nightie
Back

Cut 1 fabric on fold,
1 lining on fold

E 2

FOLD BACK THIS MARGIN

G 2

FOLD BACK THIS MARGIN

FOLD

G 2

FOLD BACK THIS MARGIN

1 2

FOLD BACK THIS MARGIN

KNEE-LENGTH CUTTING LINE

1 2

FOLD BACK THIS MARGIN

K 2

FOLD BACK THIS MARGIN



K
2

FOLD BACK THIS MARGIN

FOLD BACK THIS MARGIN



FOLD BACK THIS MARGIN

6 H

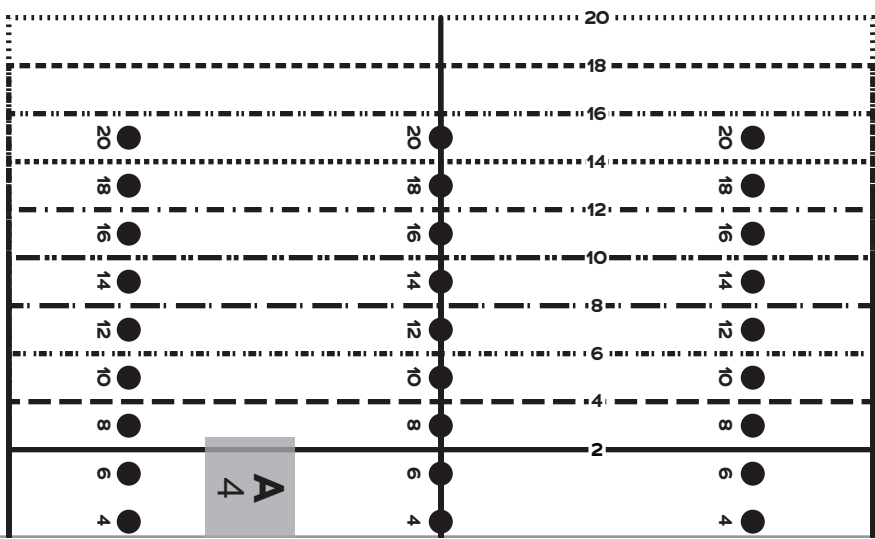

GATHER BETWEEN CIRCLES

A 4

9 I



FOLD BACK THIS MARGIN



FOLD BACK THIS MARGIN

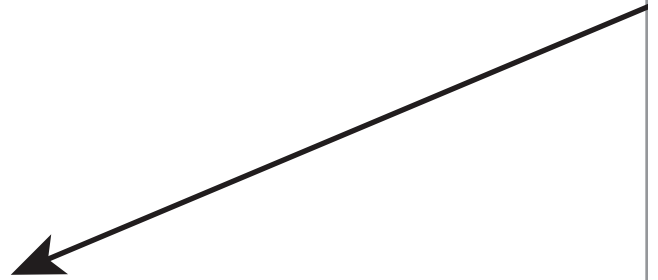

E

FOLD BACK THIS MARGIN

B

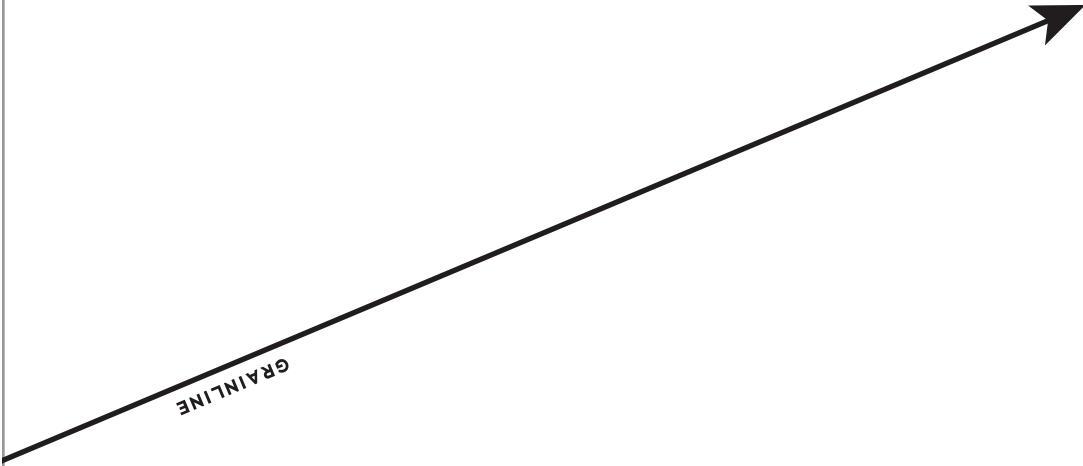

FOLD BACK THIS MARGIN

Robe
Sleeve
Cut 2 fabric,
2 tulle (optional)

9

SIZES 2-20

**YHONCHY
FRENCH
PEIGNOT
SET**



E

C

9 B

FOLD BACK THIS MARGIN

R BETWEEN CIRCLES

9 A

FOLD BACK THIS MARGIN

9 C

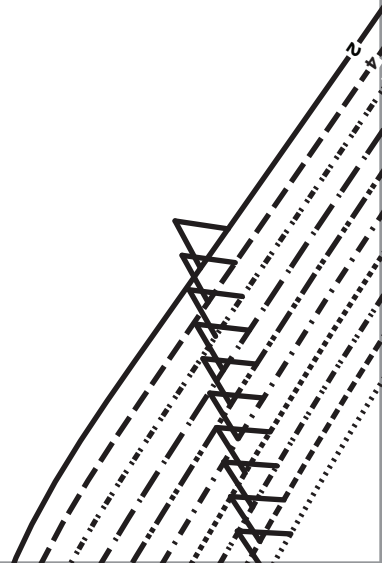

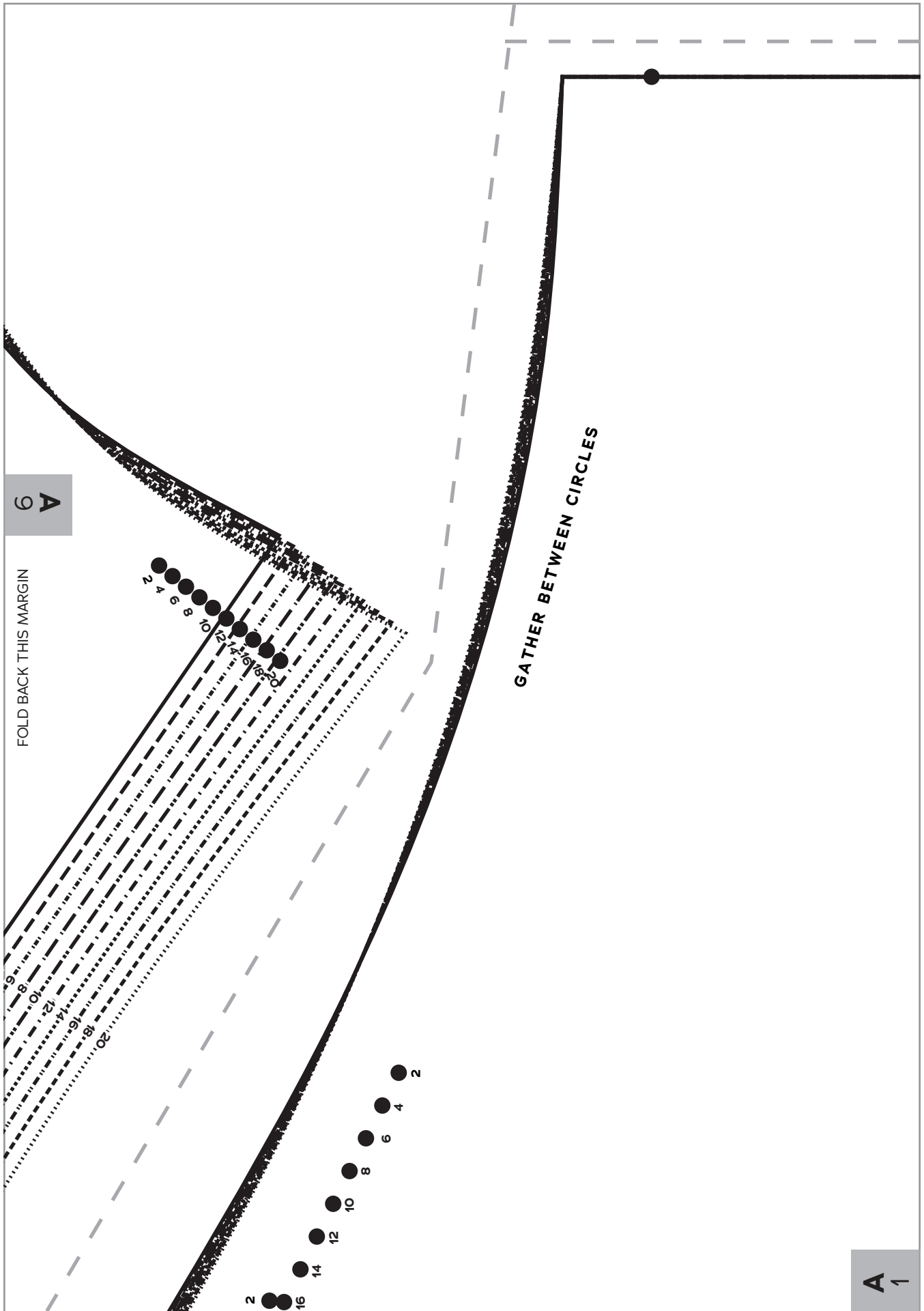

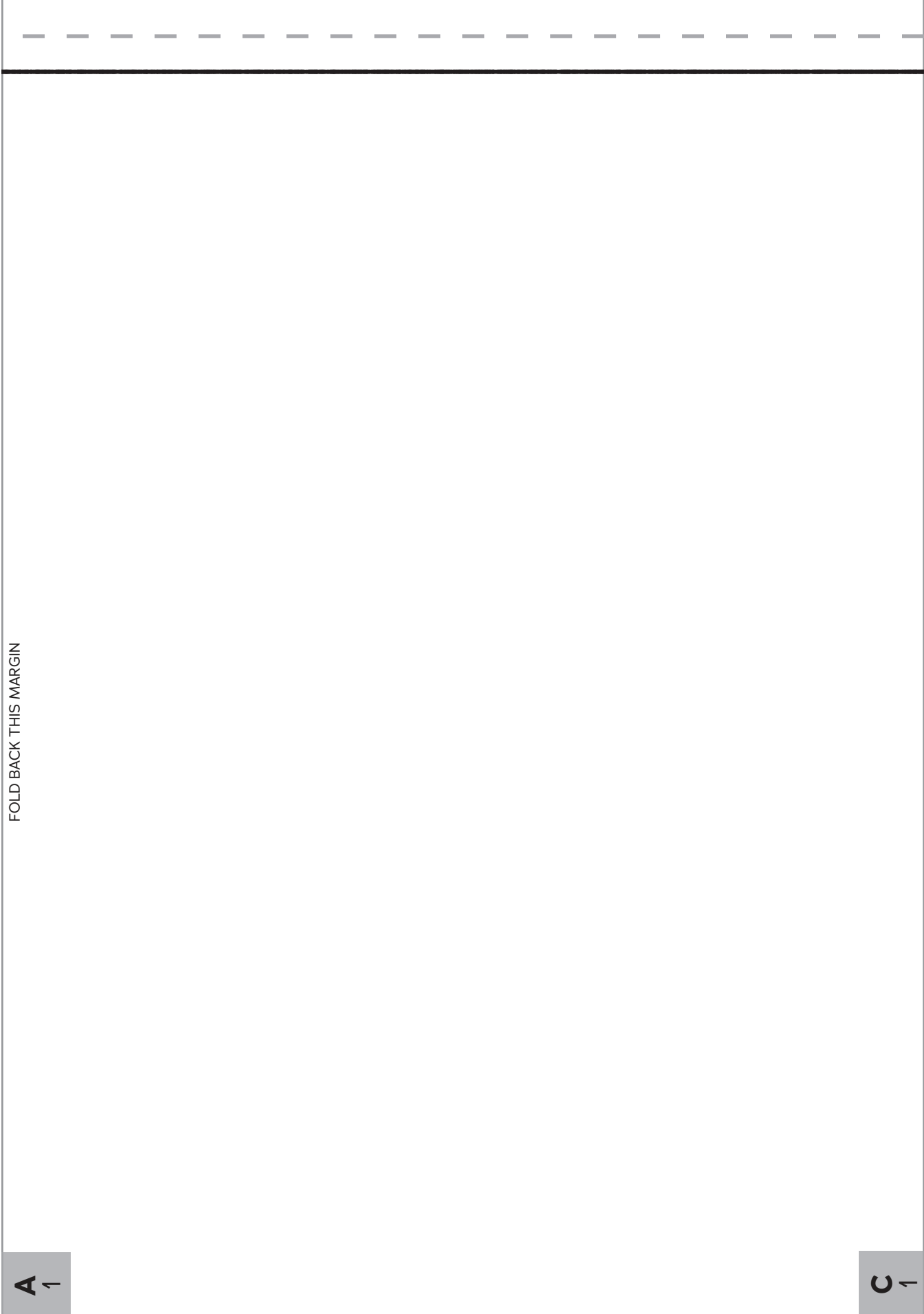

FOLD BACK THIS MARGIN

A 1

C 1

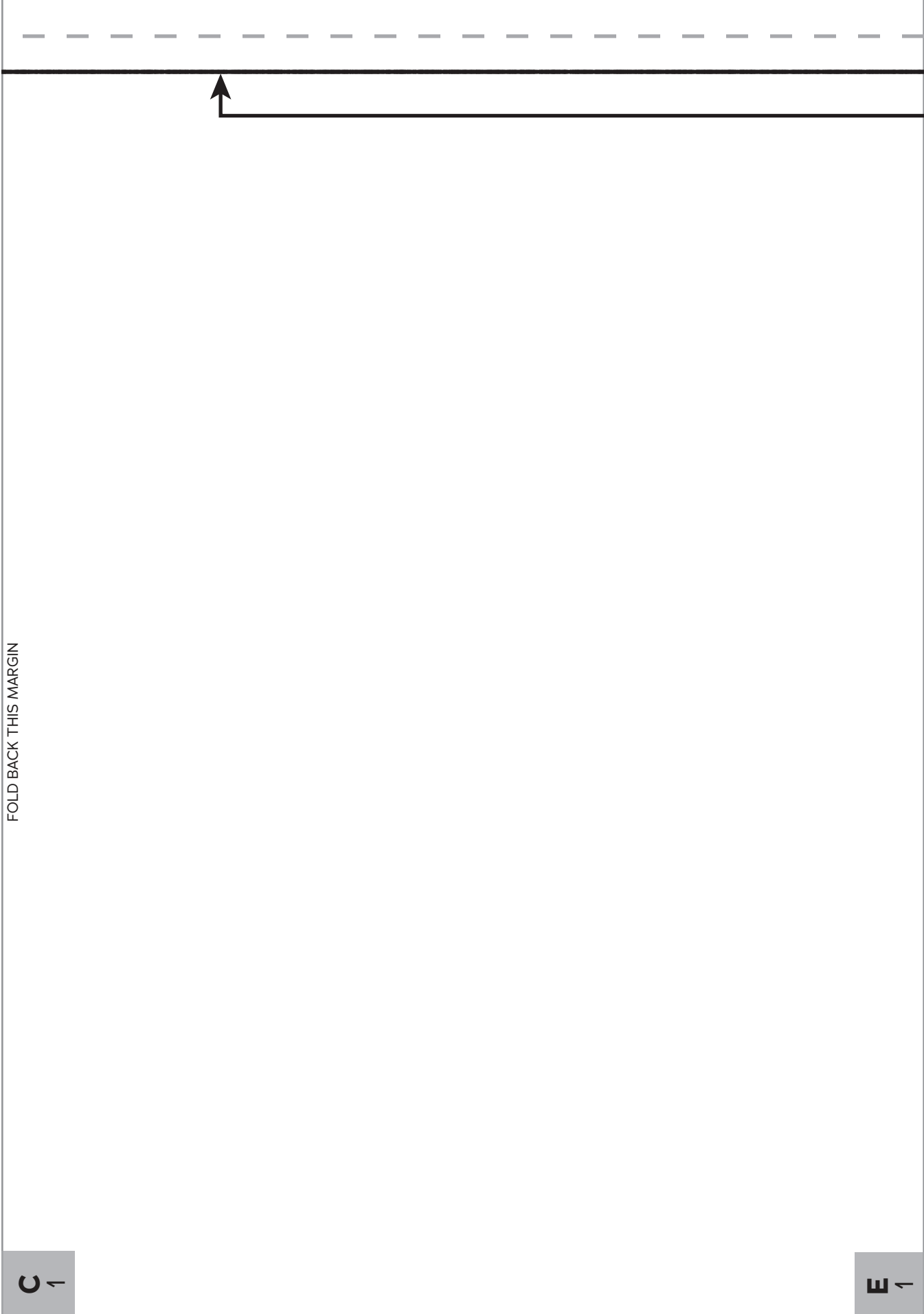

FOLD BACK THIS MARGIN

C ←

E ←

FOLD BACK THIS MARGIN



**FRENCHY
PEIGNOIR
SET**

SIZES 2-20

1

Nightie
Front

Cut 1 fabric on fold,
1 lining on fold

E 1

G 1



FOLD

FOLD BACK THIS MARGIN



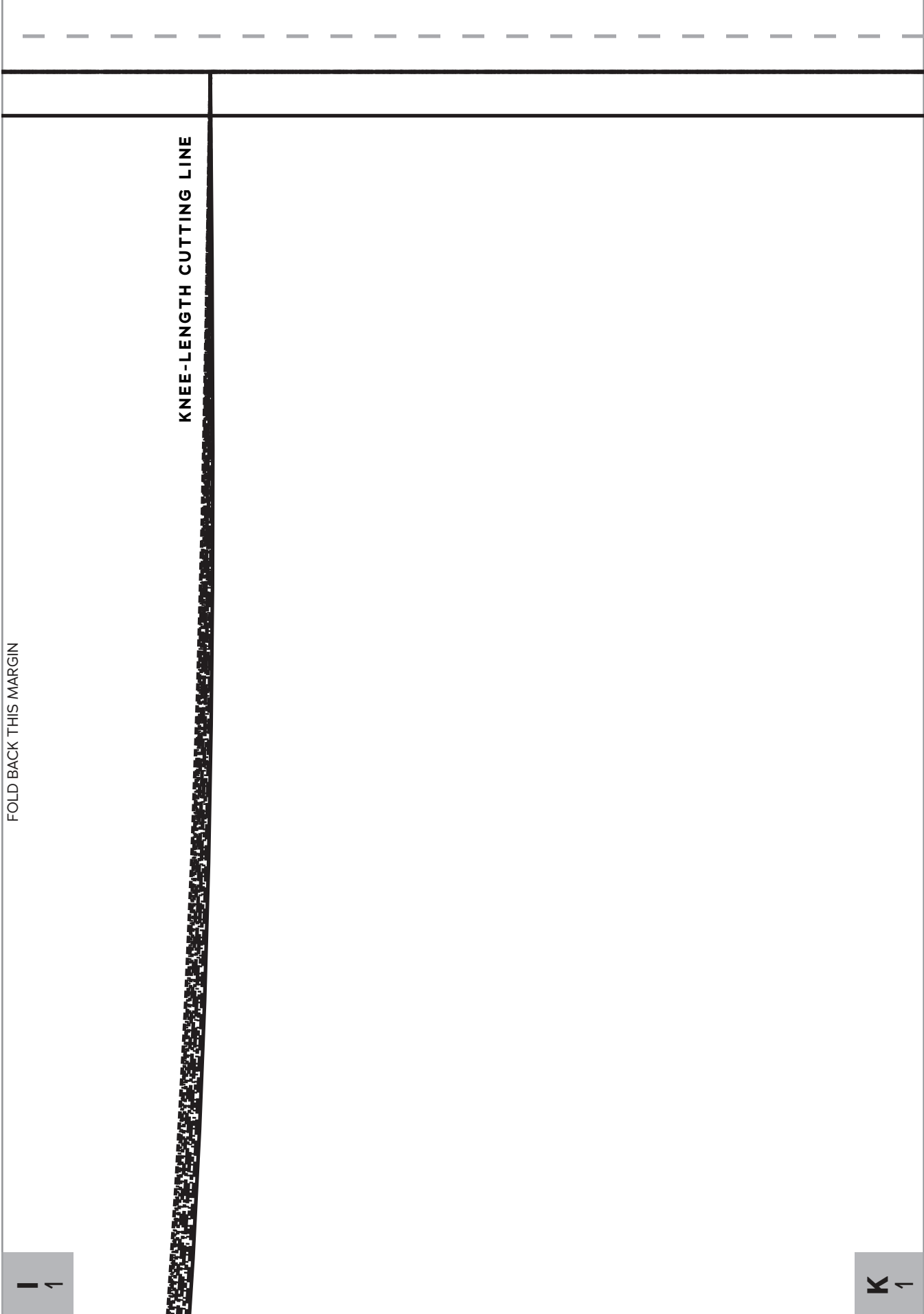

KNEE-LENGTH CUTTING LINE

FOLD BACK THIS MARGIN

K 1

K 1

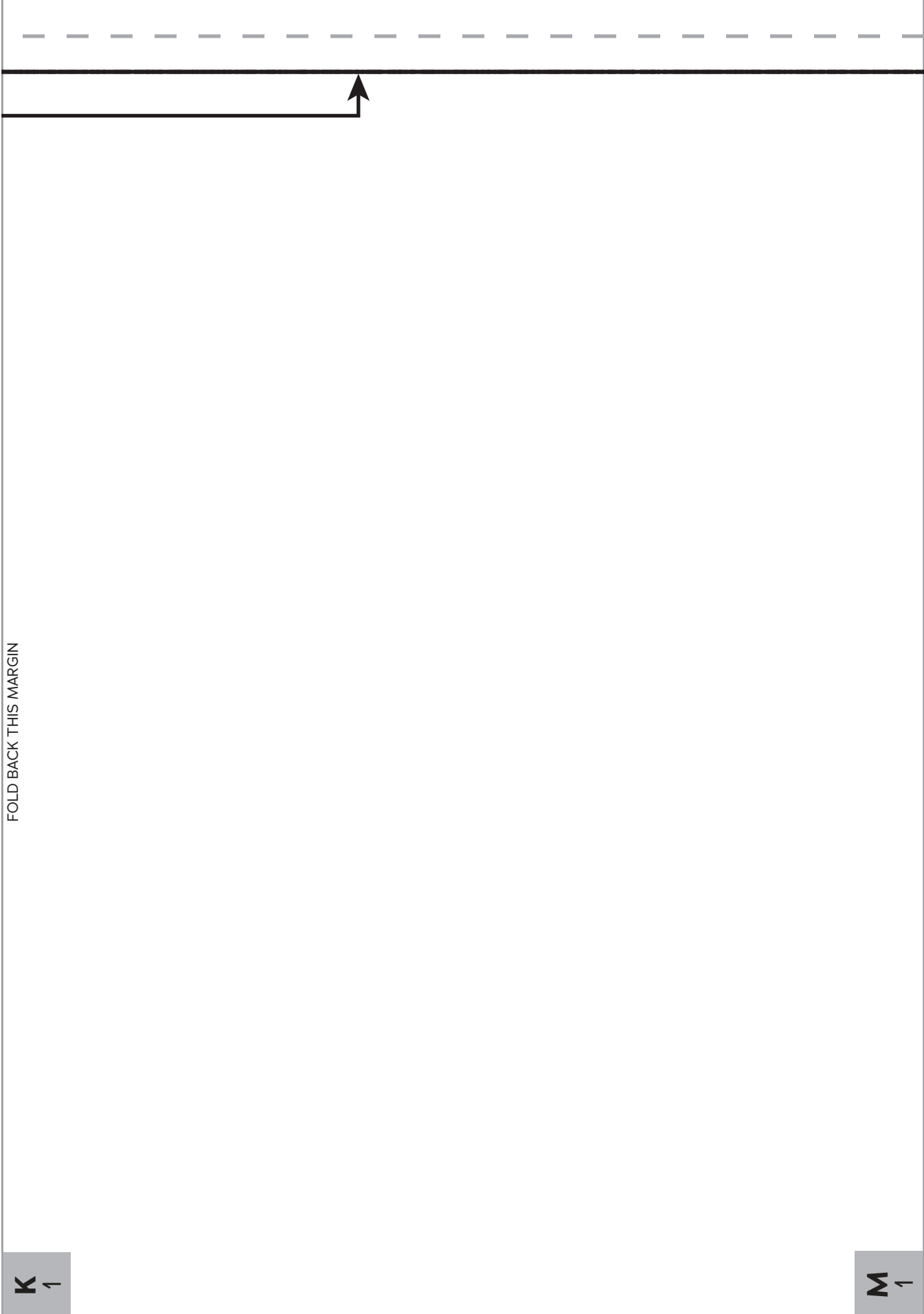

FOLD BACK THIS MARGIN

M 2

1



2

FOLD BACK THIS MARGIN

2

A
4

2



**FRENCHY
PEIGNOIR
SET**

SIZES 2-20

4

Nightie
Sleeve

Cut 2 fabric

B
4

GRAINLINE



6 |

FOLD BACK THIS MARGIN

6 |

FOLD BACK THIS
MARGIN

6 |

6 F

FOLD BACK THIS MARGIN

6 C

FOLD BACK THIS MARGIN

6 G

6 D

6 C

FOLD BACK THIS MARGIN

FOLD BACK THIS MARGIN

6 D

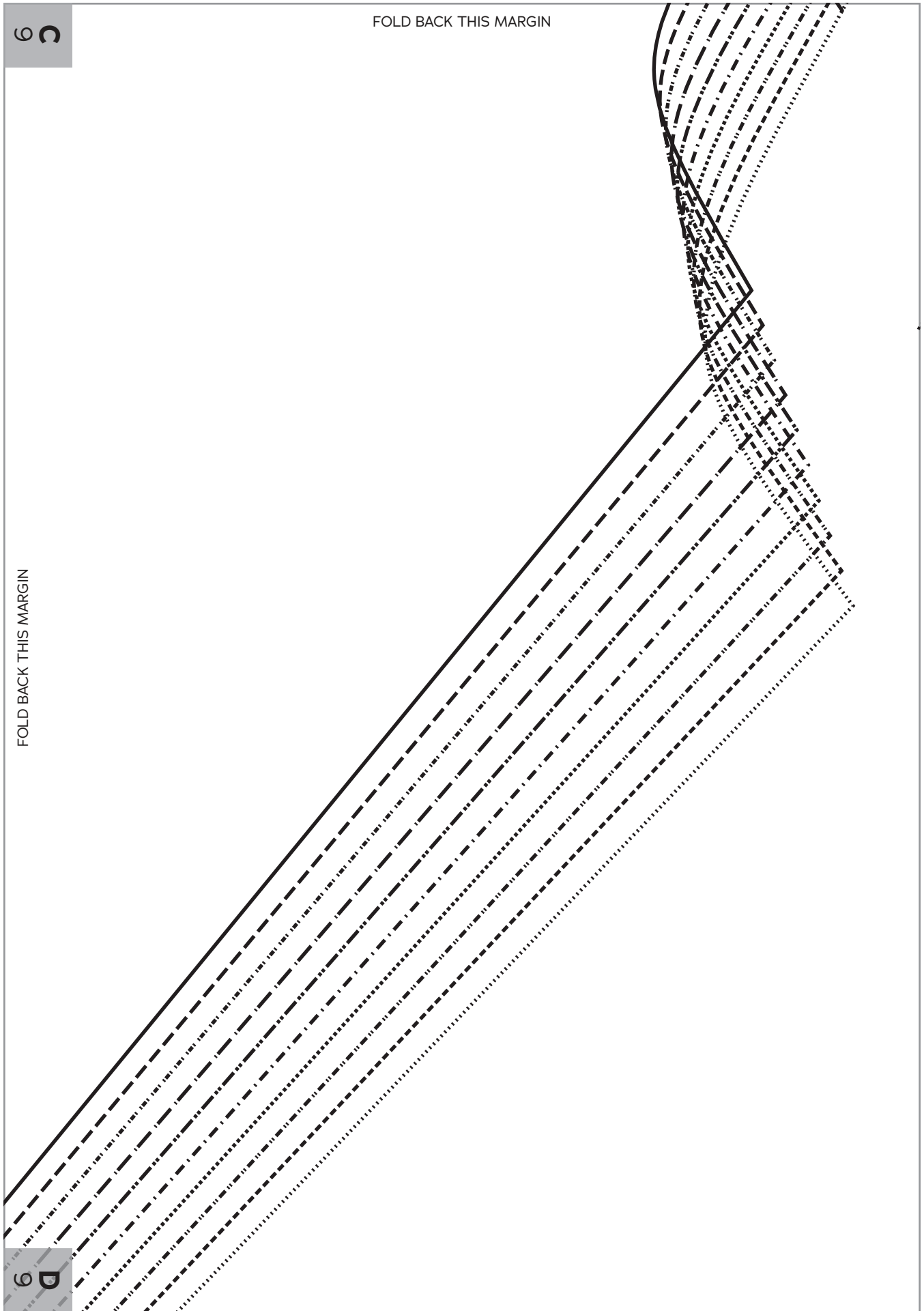

FOLD BACK THIS MARGIN

A
↑

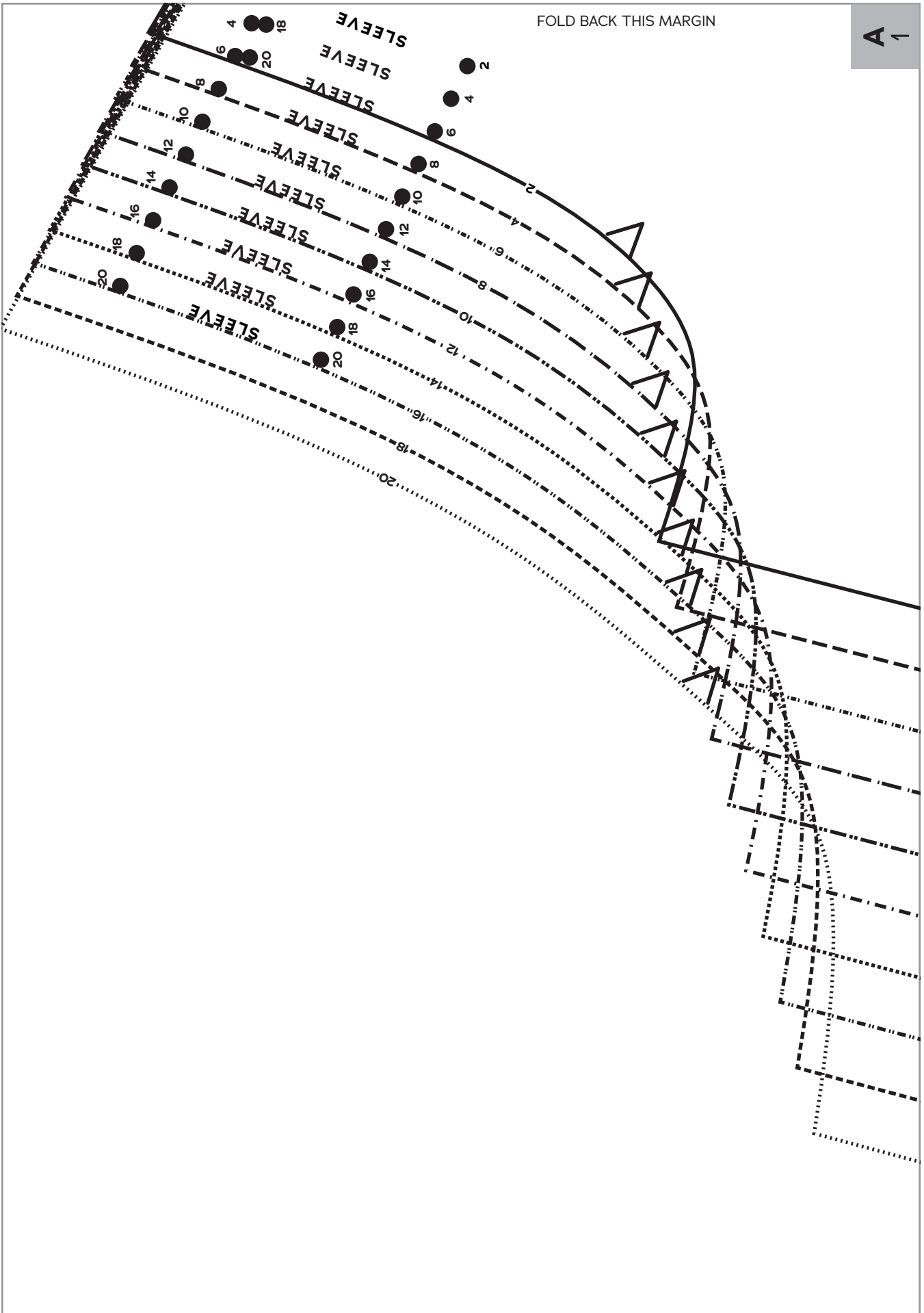

FOLD BACK THIS MARGIN

A 1

C 1

FOLD BACK THIS MARGIN

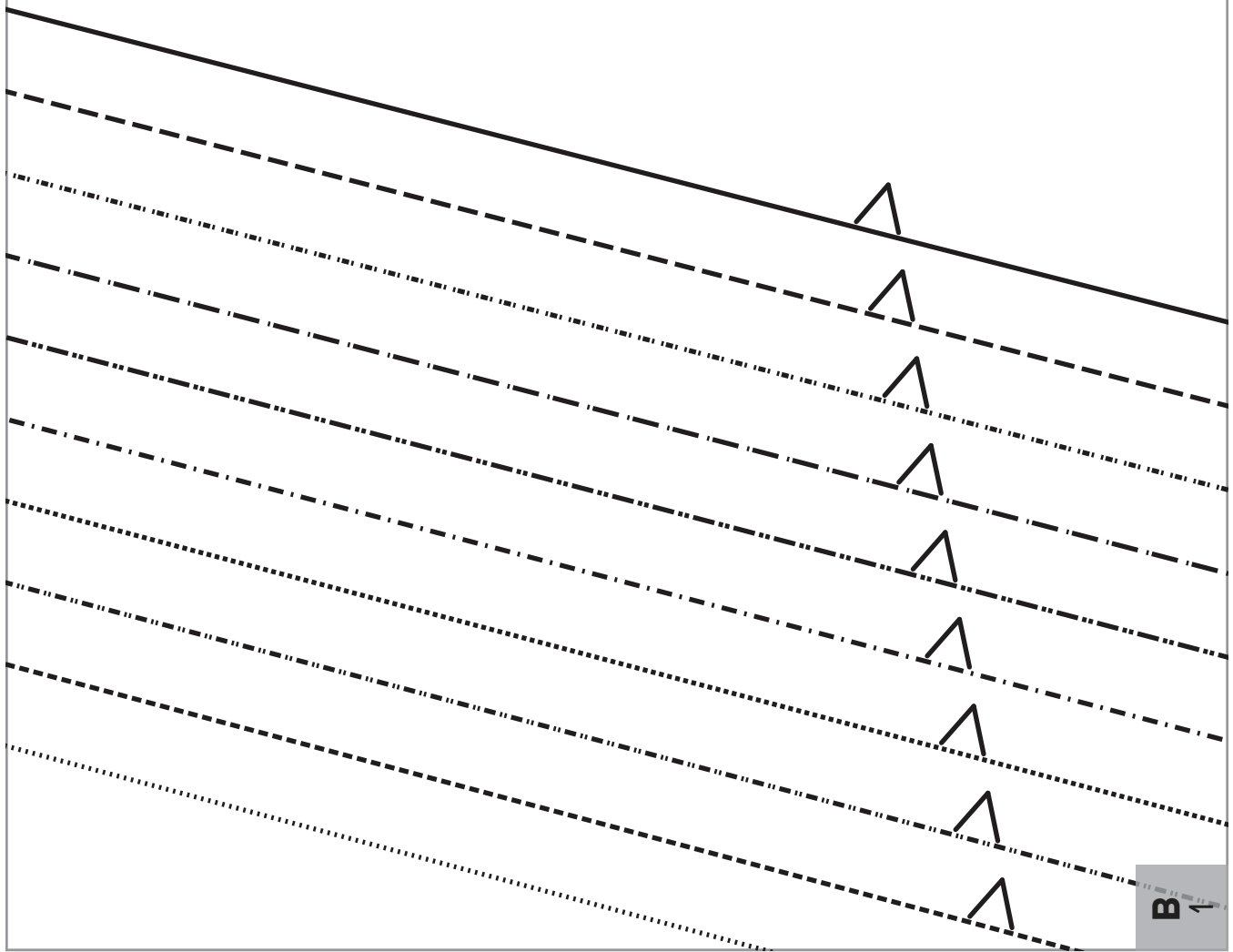

FOLD BACK THIS MARGIN

C ↴

E ↴

FOLD BACK THIS MARGIN

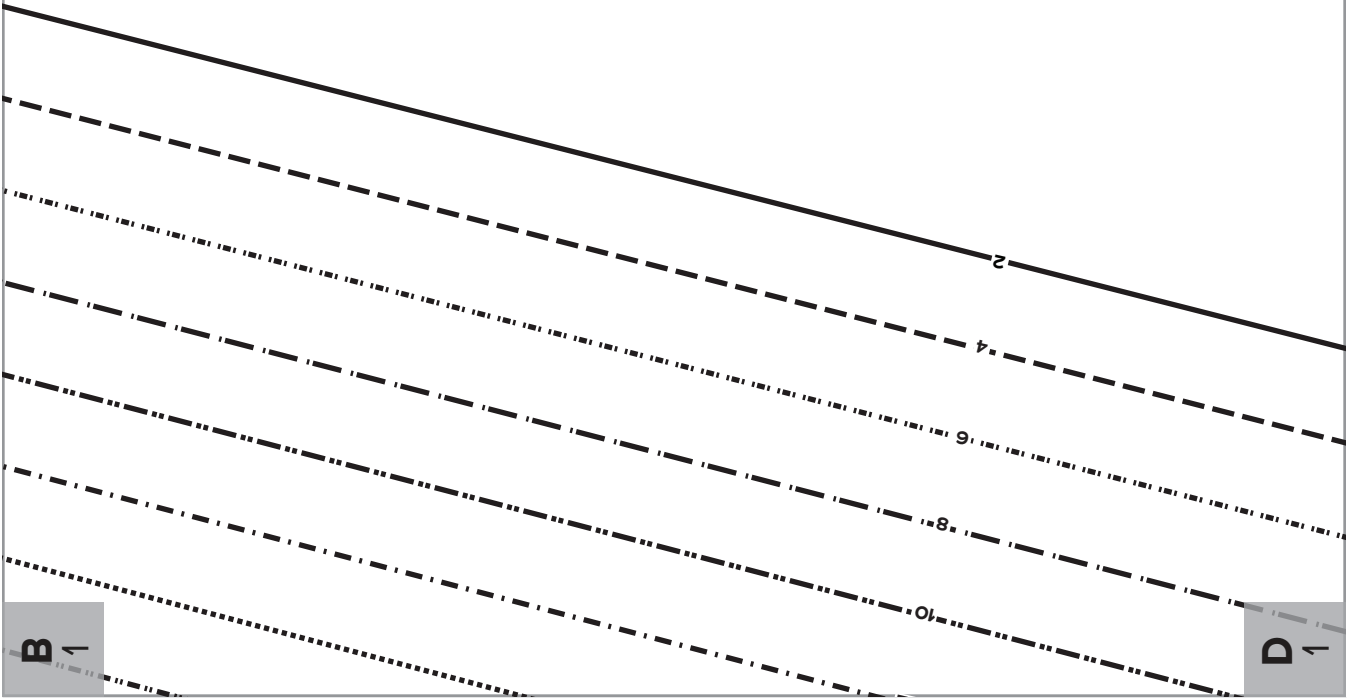

FOLD BACK THIS MARGIN

E ↴

G ↴

FOLD BACK THIS MARGIN

D ↴

F ↴

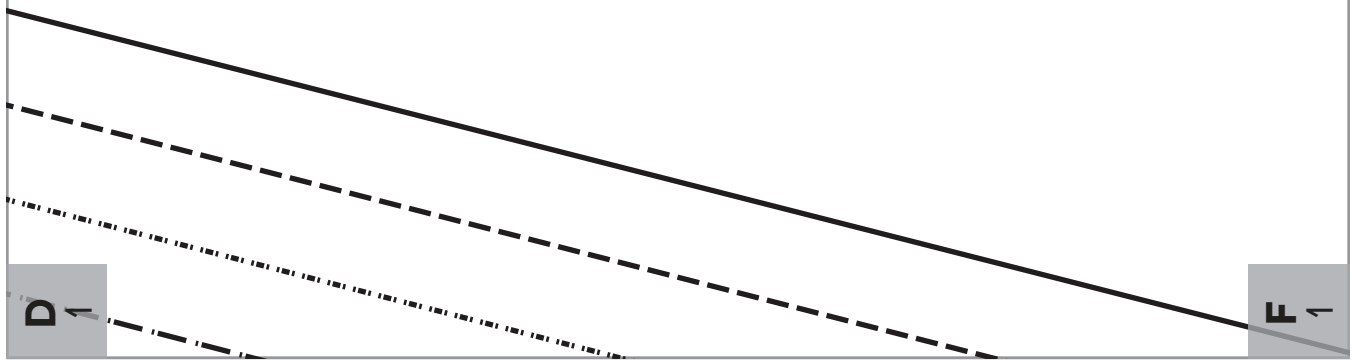

FOLD BACK THIS MARGIN

G ↵

— ↵

FOLD BACK THIS MARGIN

F ↵

H ↵

FOLD BACK THIS MARGIN

K ↙

I ↘

FOLD BACK THIS MARGIN

J ↙

H ↘

FOLD BACK THIS MARGIN

K 1

M 1

FOLD BACK THIS MARGIN

J 1

L 1

M
1

FOLD BACK THIS MARGIN

FOLD BACK THIS MARGIN

L
1

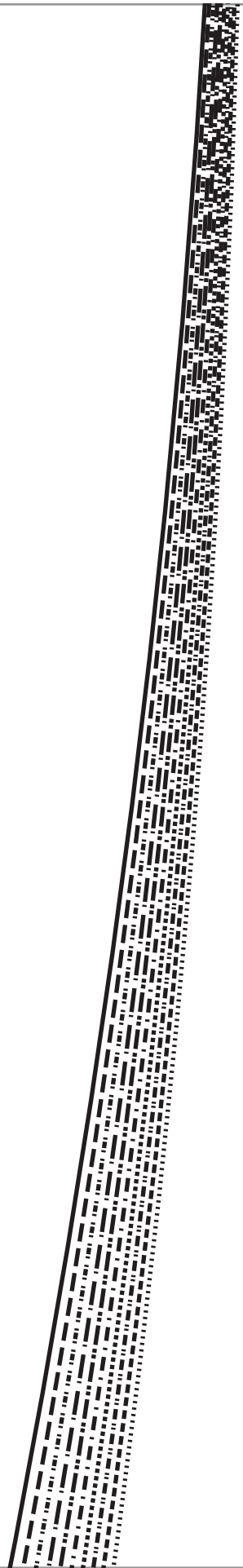

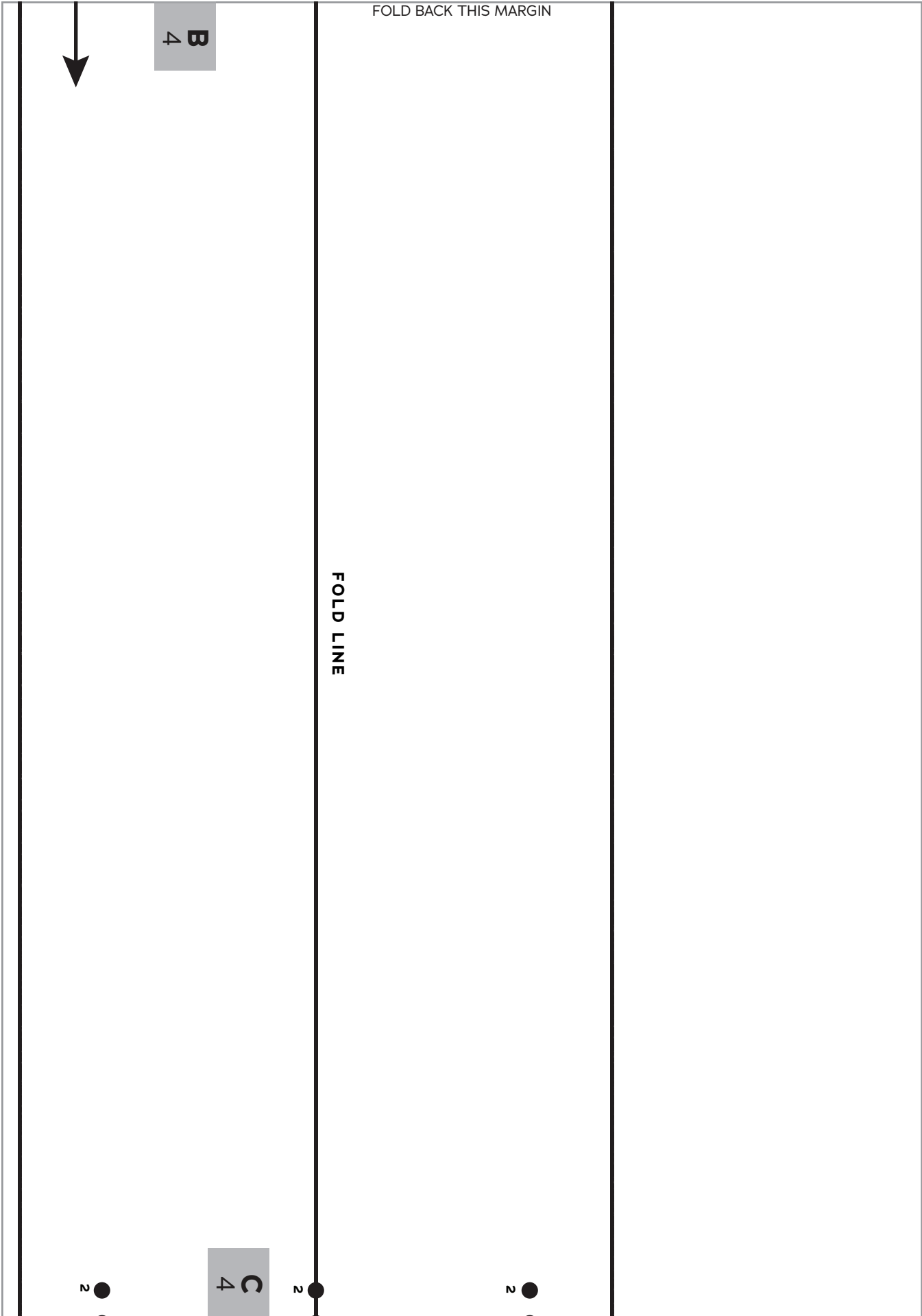

FOLD BACK THIS
MARGIN



9
KK

6 G

FOLD BACK THIS MARGIN

6 D

FOLD BACK THIS MARGIN

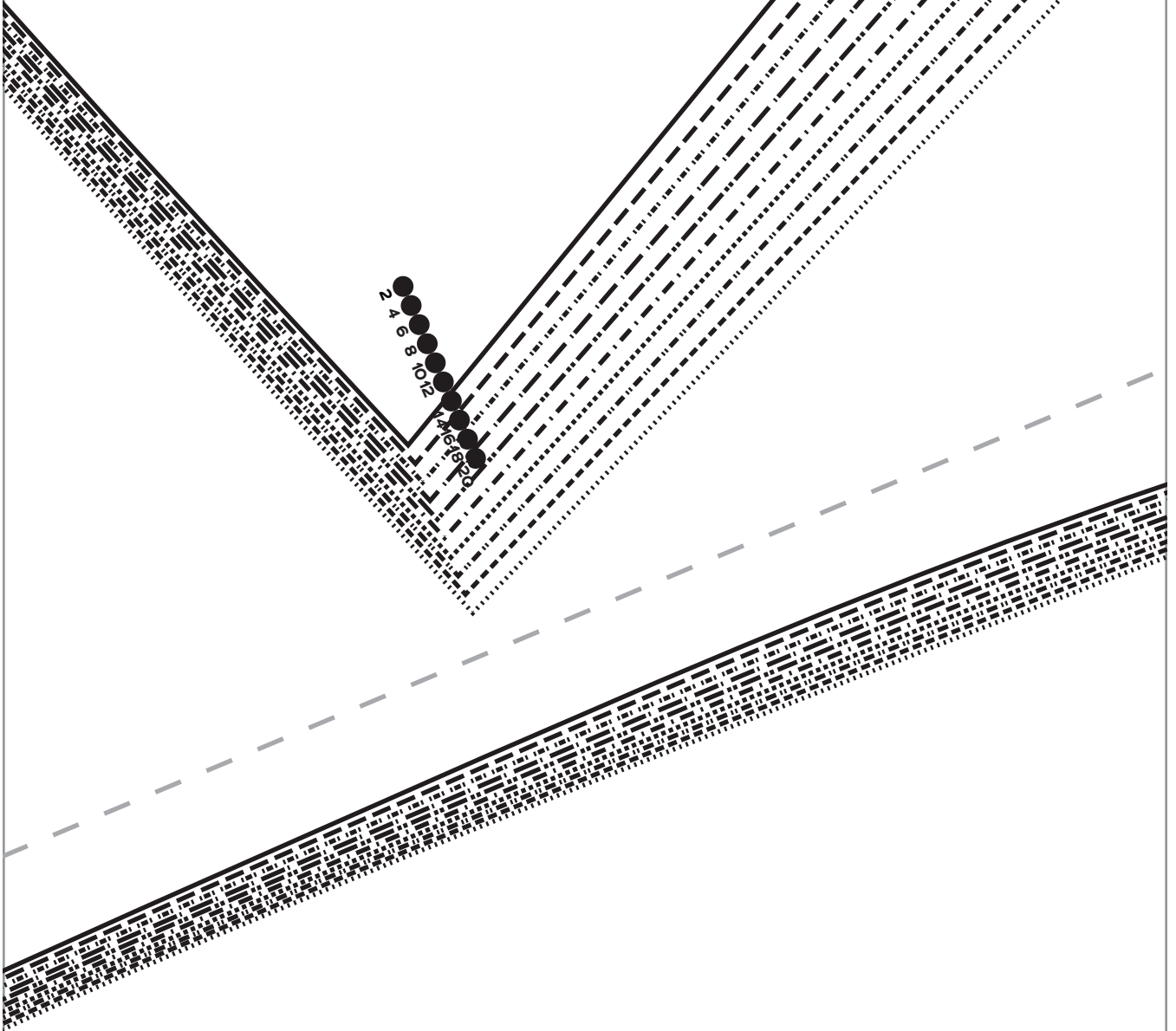

FOLD BACK THIS MARGIN

6 KK

6 JJ



FOLD BACK THIS MARGIN

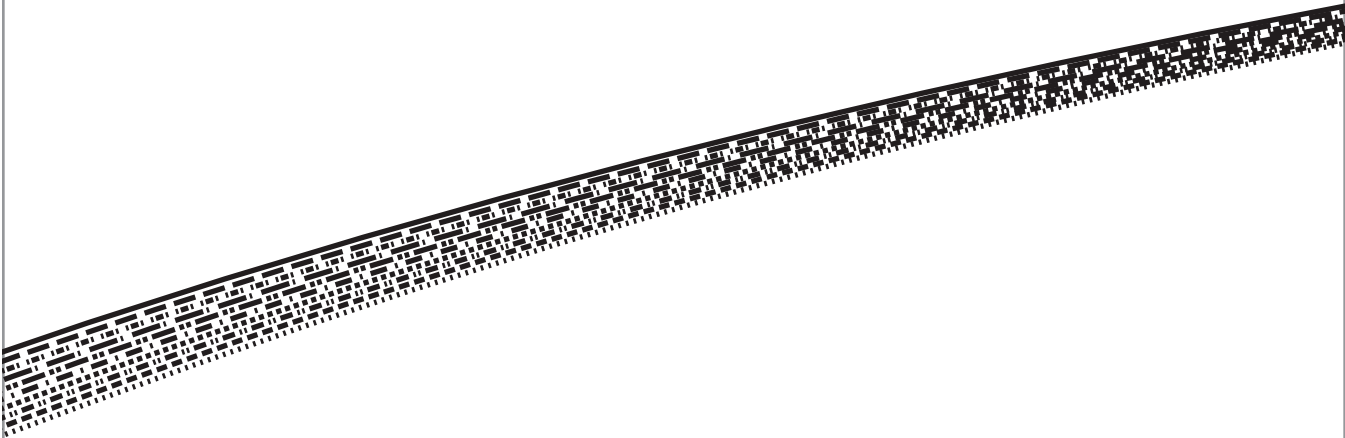

FOLD BACK THIS MARGIN



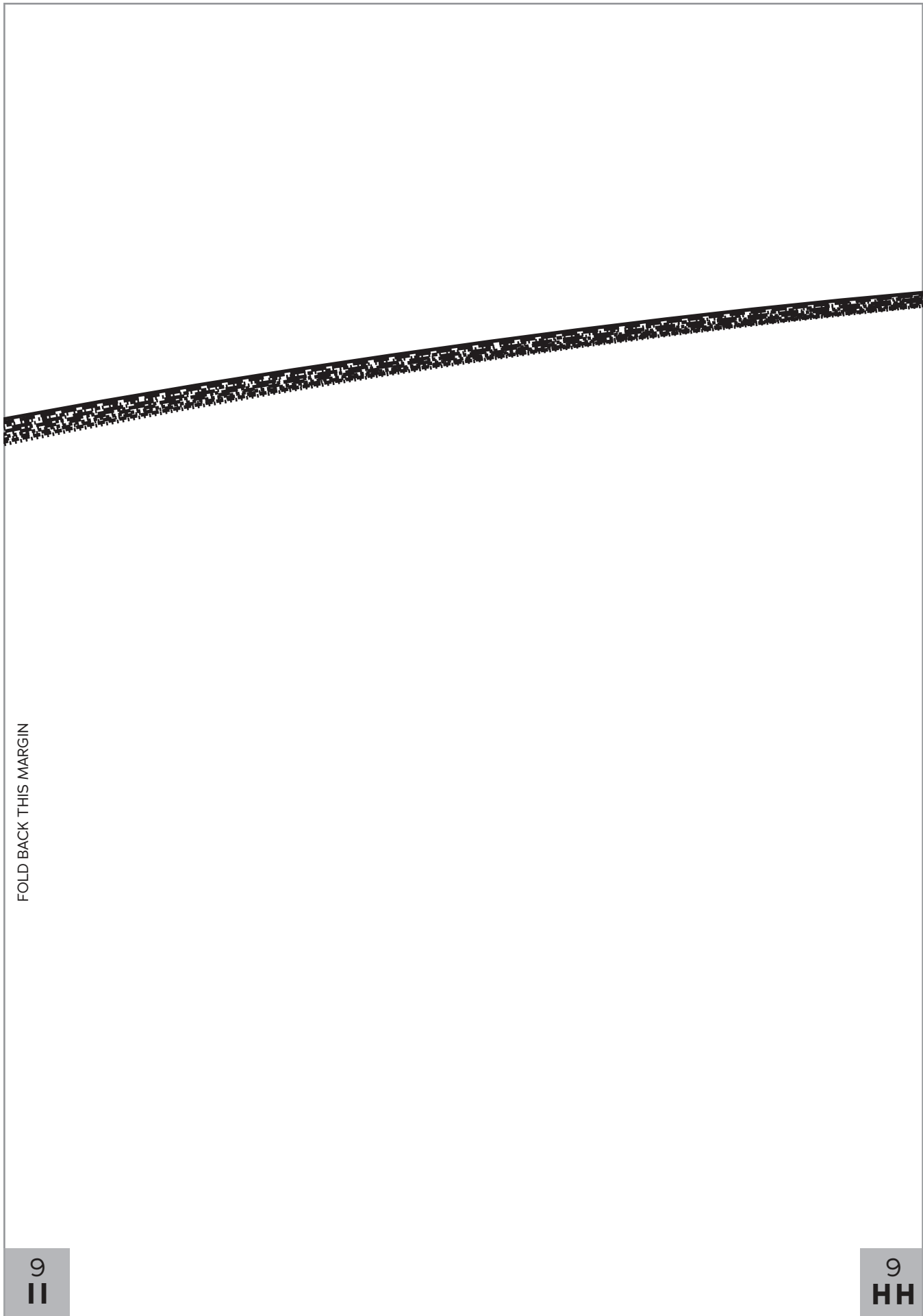

FOLD BACK THIS MARGIN

9
HH

9
HH

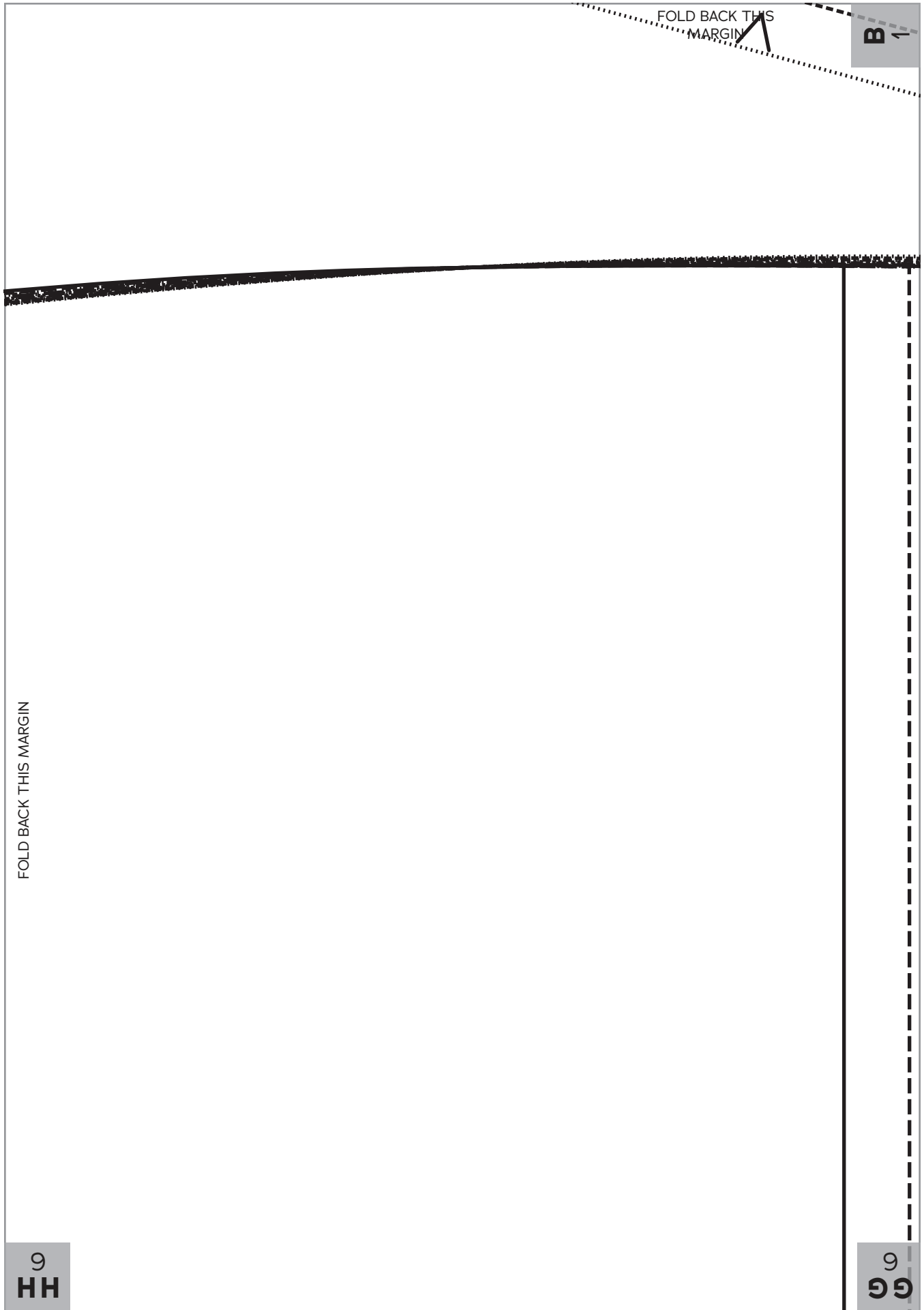

FOLD BACK THIS MARGIN

B

FOLD BACK THIS MARGIN

9
HH

9
99

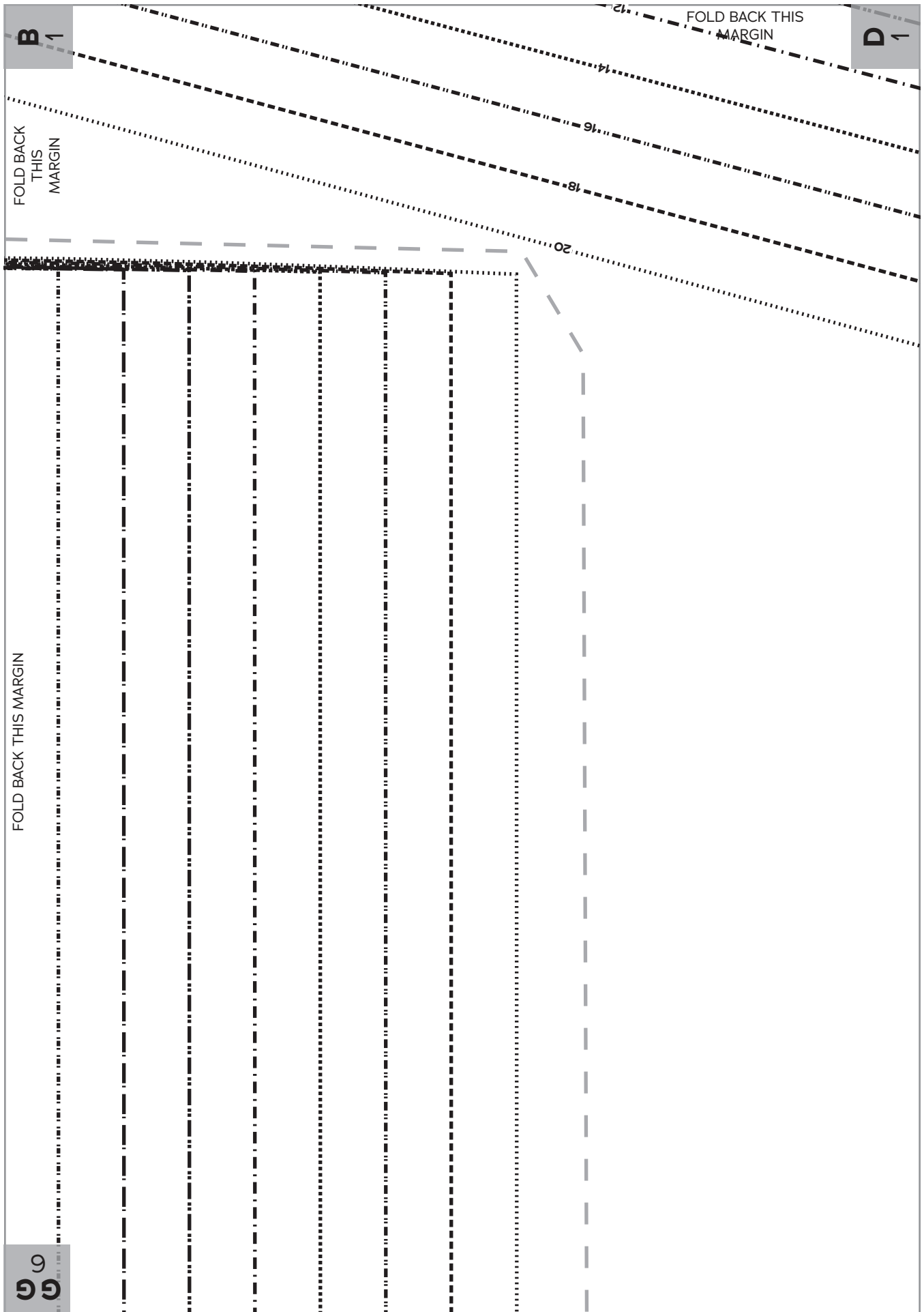

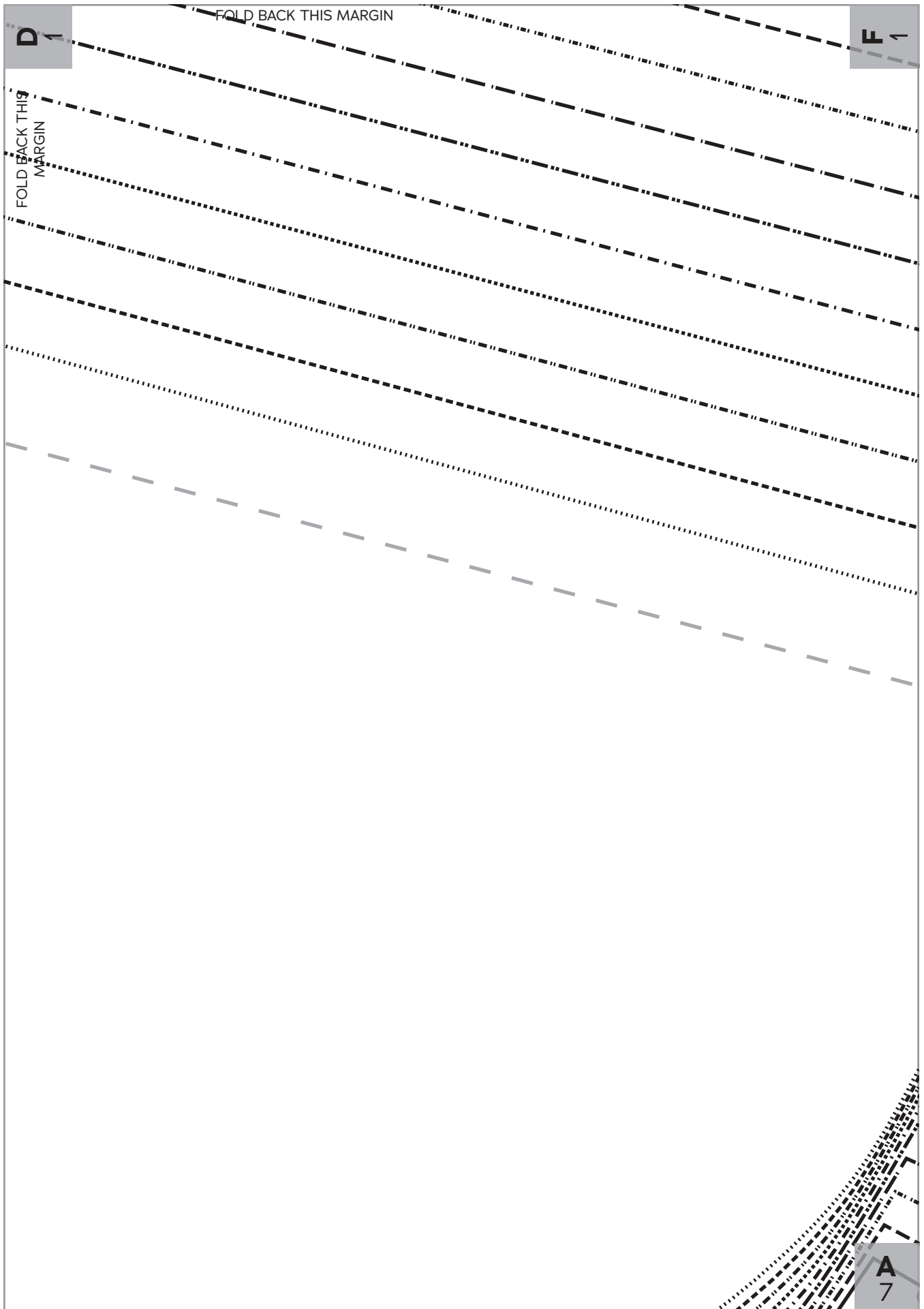

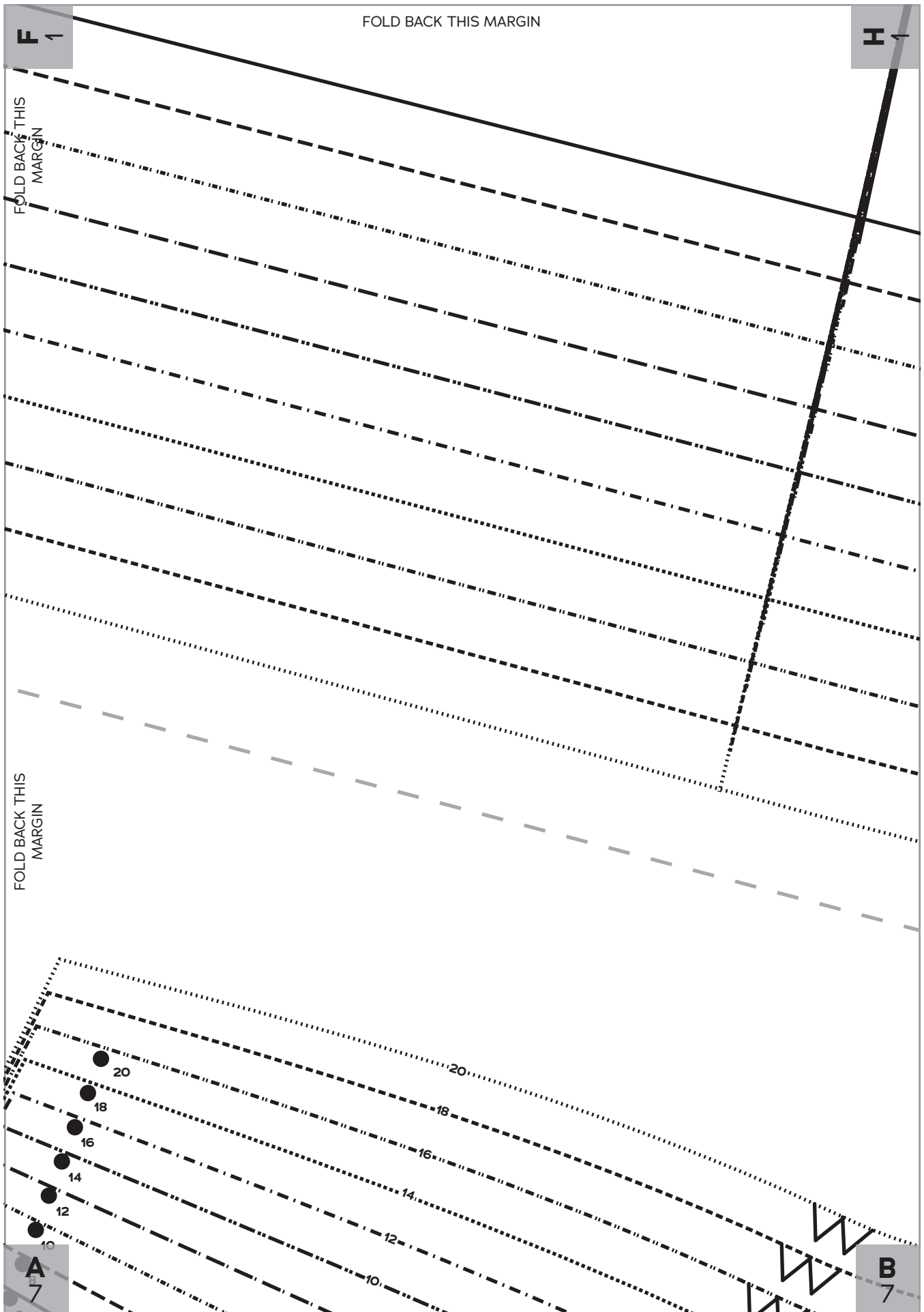

H
1

FOLD BACK THIS MARGIN

J
1

FOLD BACK THIS
MARGIN

FOLD BACK THIS
MARGIN

B
7

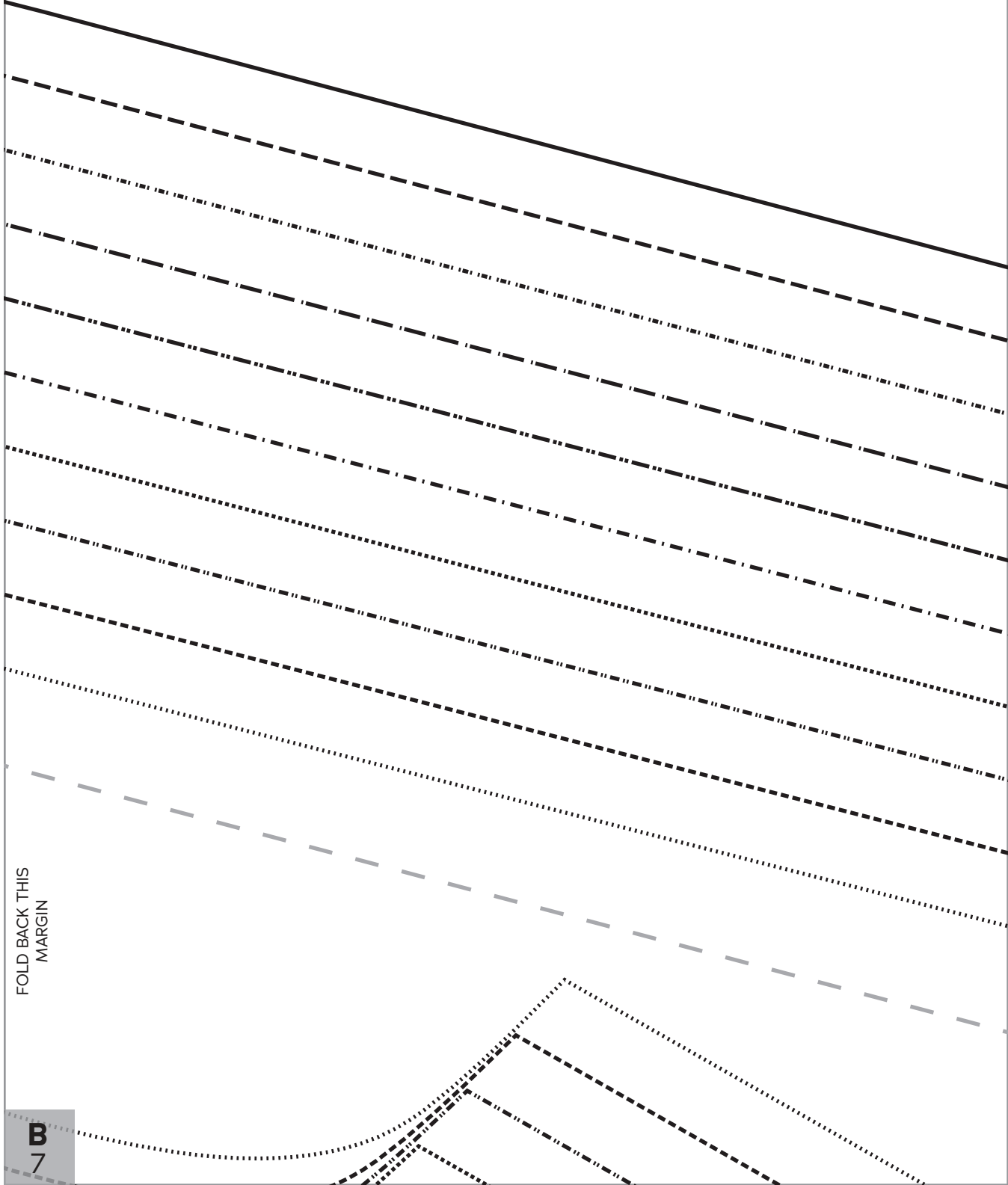

FOLD BACK THIS MARGIN

FOLD BACK THIS MARGIN

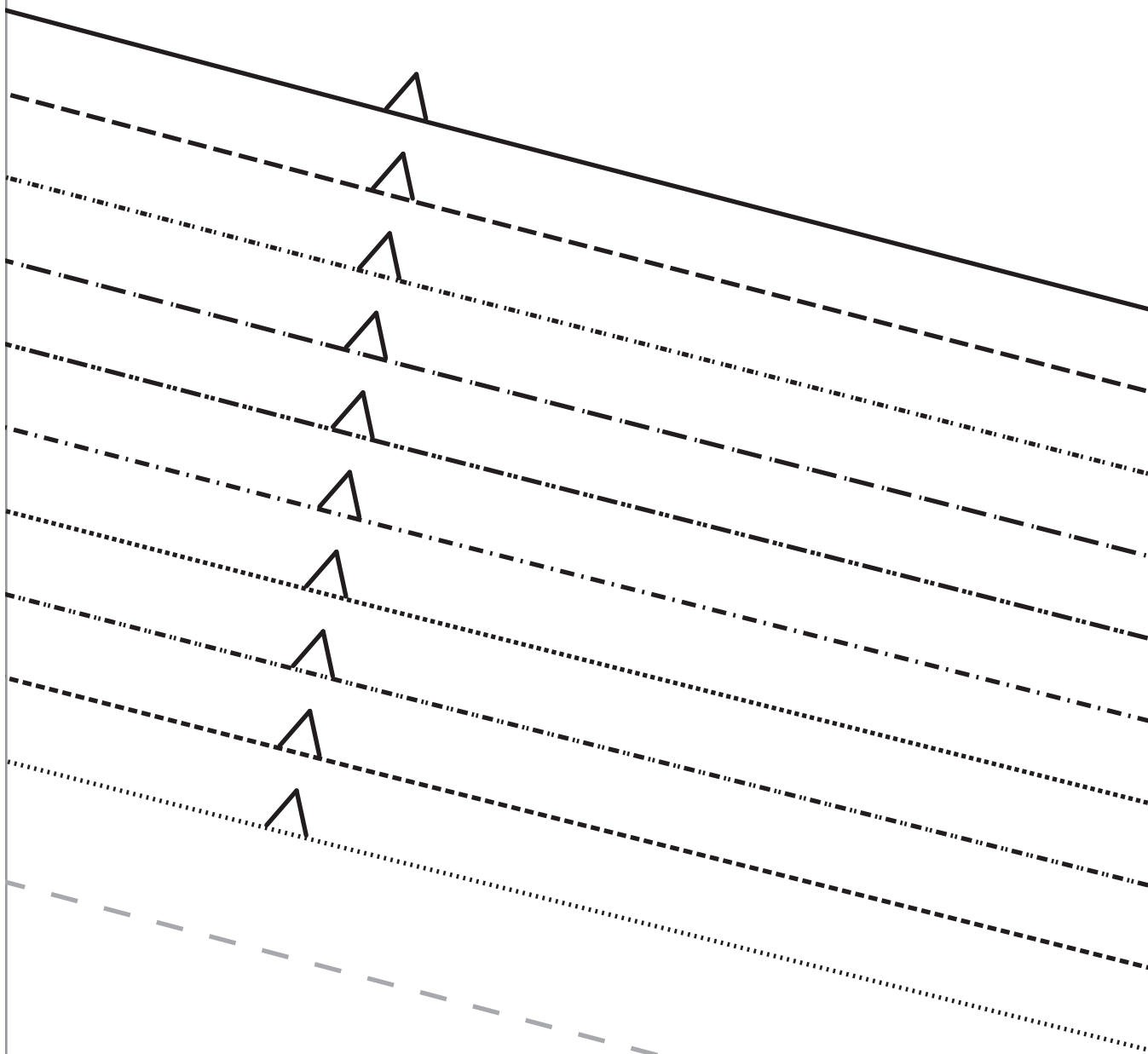

L 1

FOLD BACK THIS MARGIN

FOLD BACK THIS MARGIN

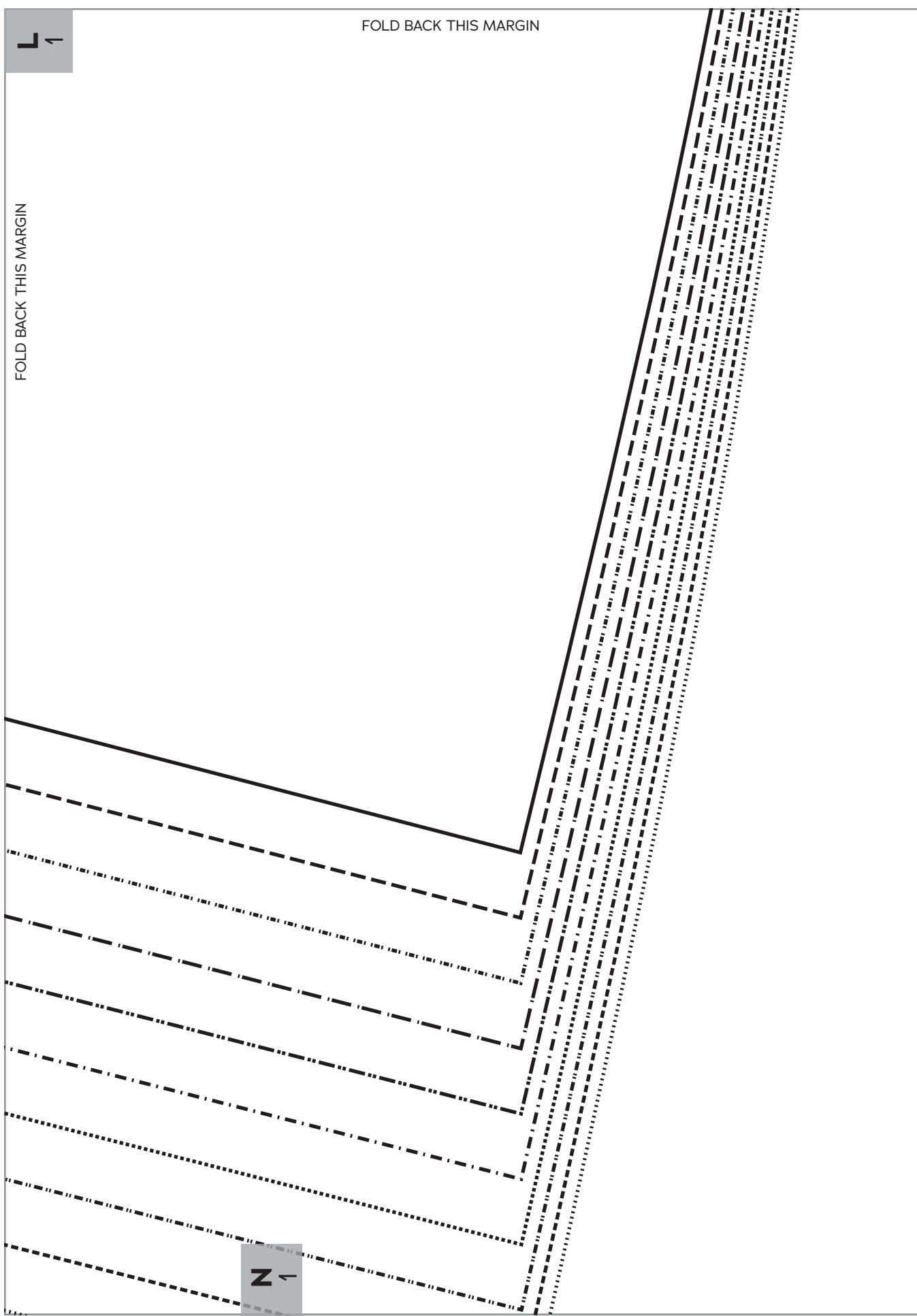



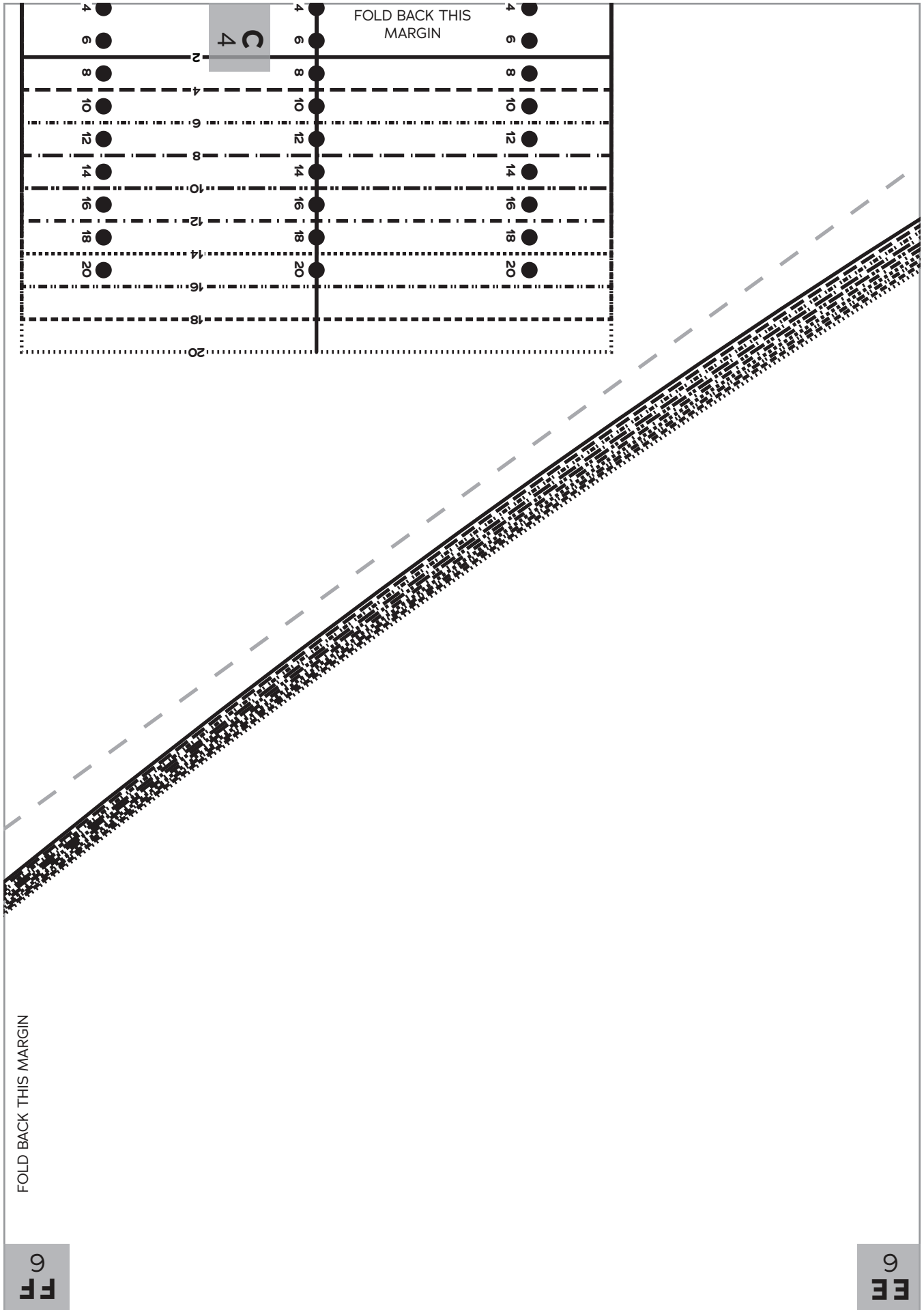

C
4

FOLD BACK THIS MARGIN

FOLD BACK THIS MARGIN

6
FF

6
EE

FOLD BACK THIS MARGIN

9
KK

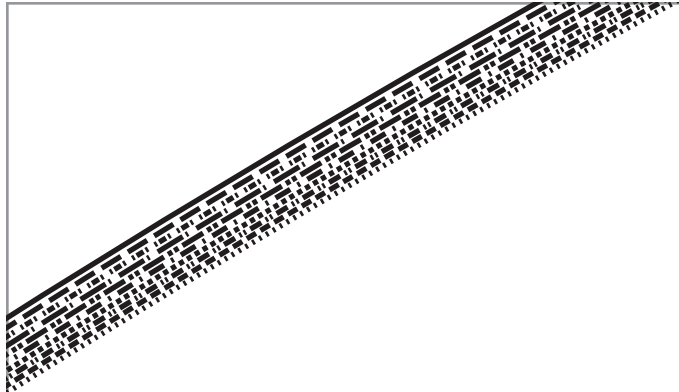

FOLD BACK THIS MARGIN

9
EE

9
DD

9
KK

FOLD BACK THIS MARGIN

9
ff

FOLD BACK THIS MARGIN

9
DD

9
CC

9
ff

FOLD BACK THIS MARGIN

9
ff

FOLD BACK THIS MARGIN

9
cc

9
BB

9
II

FOLD BACK THIS MARGIN

9
HH

FOLD BACK THIS MARGIN

6
BB

6
AA

9
HH

FOLD BACK THIS MARGIN

9
GG

FOLD BACK THIS MARGIN

9
AA

9
ZZ

9
C

FOLD
BACK
THIS
MARGIN

FOLD BACK THIS MARGIN

N
9

C
7

FOLD BACK THIS MARGIN

A
7

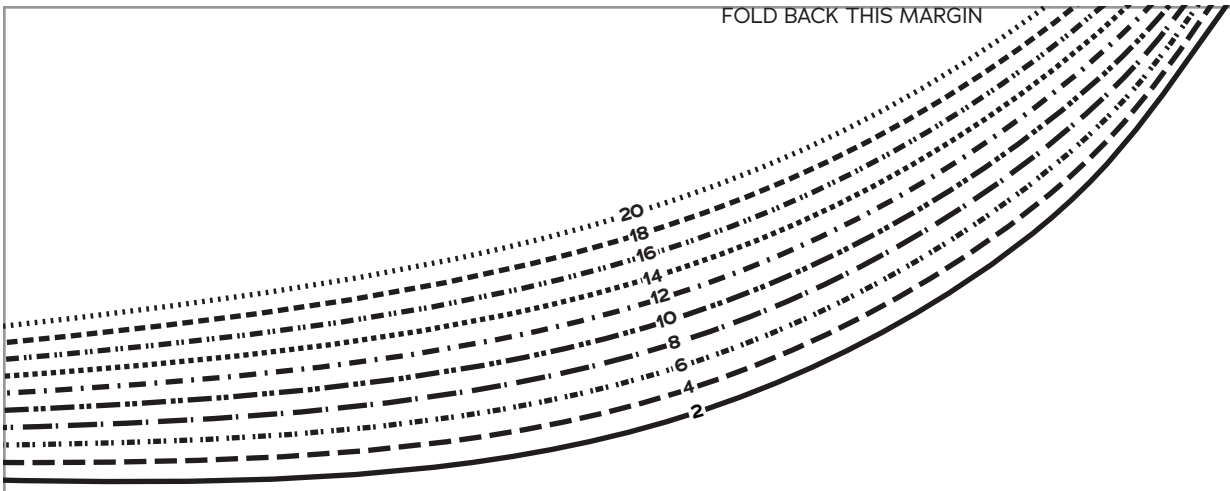

FOLD BACK THIS MARGIN

C
7

D
7

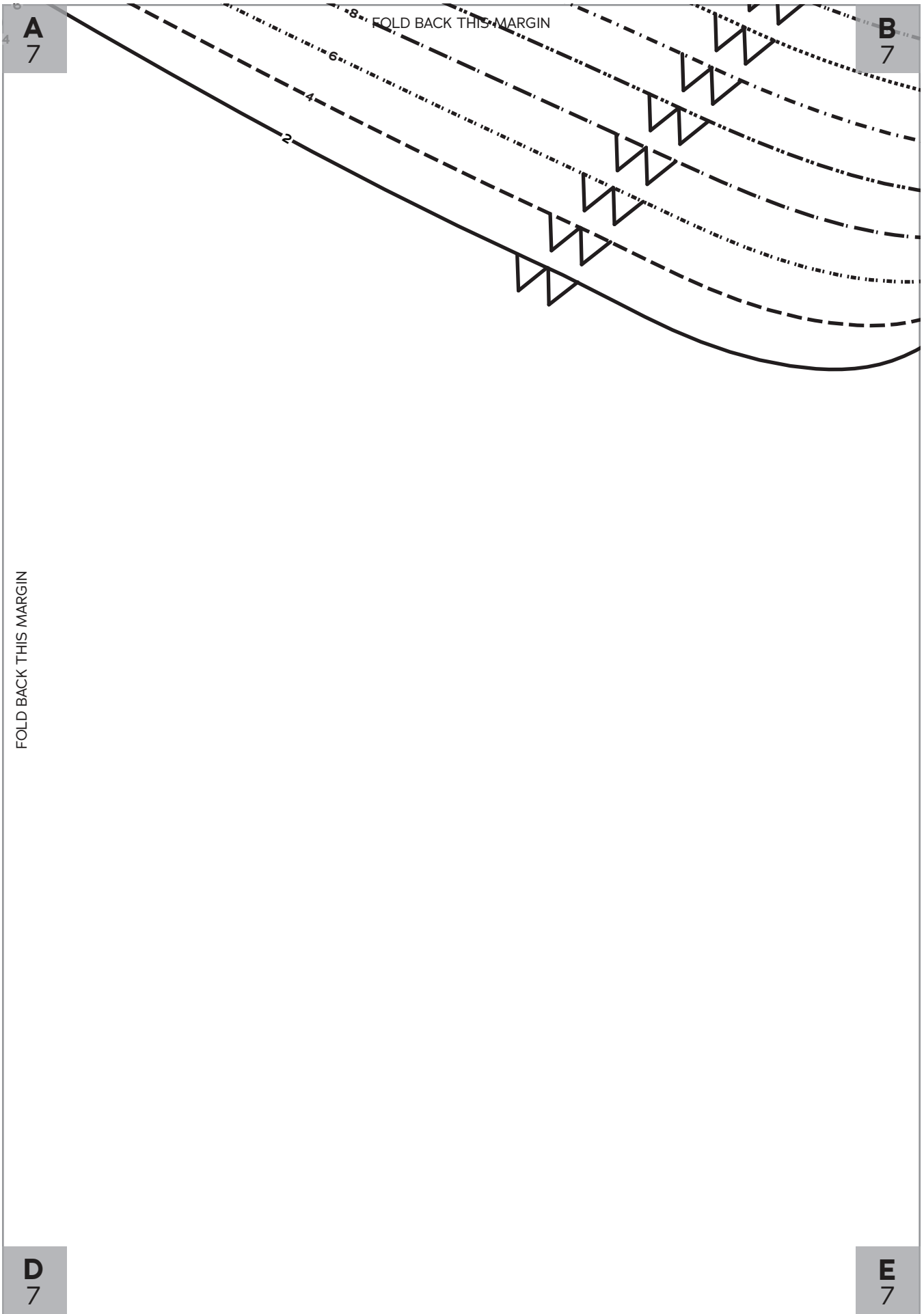

B
7

FOLD BACK THIS MARGIN

FOLD BACK THIS MARGIN

E
7

F
7

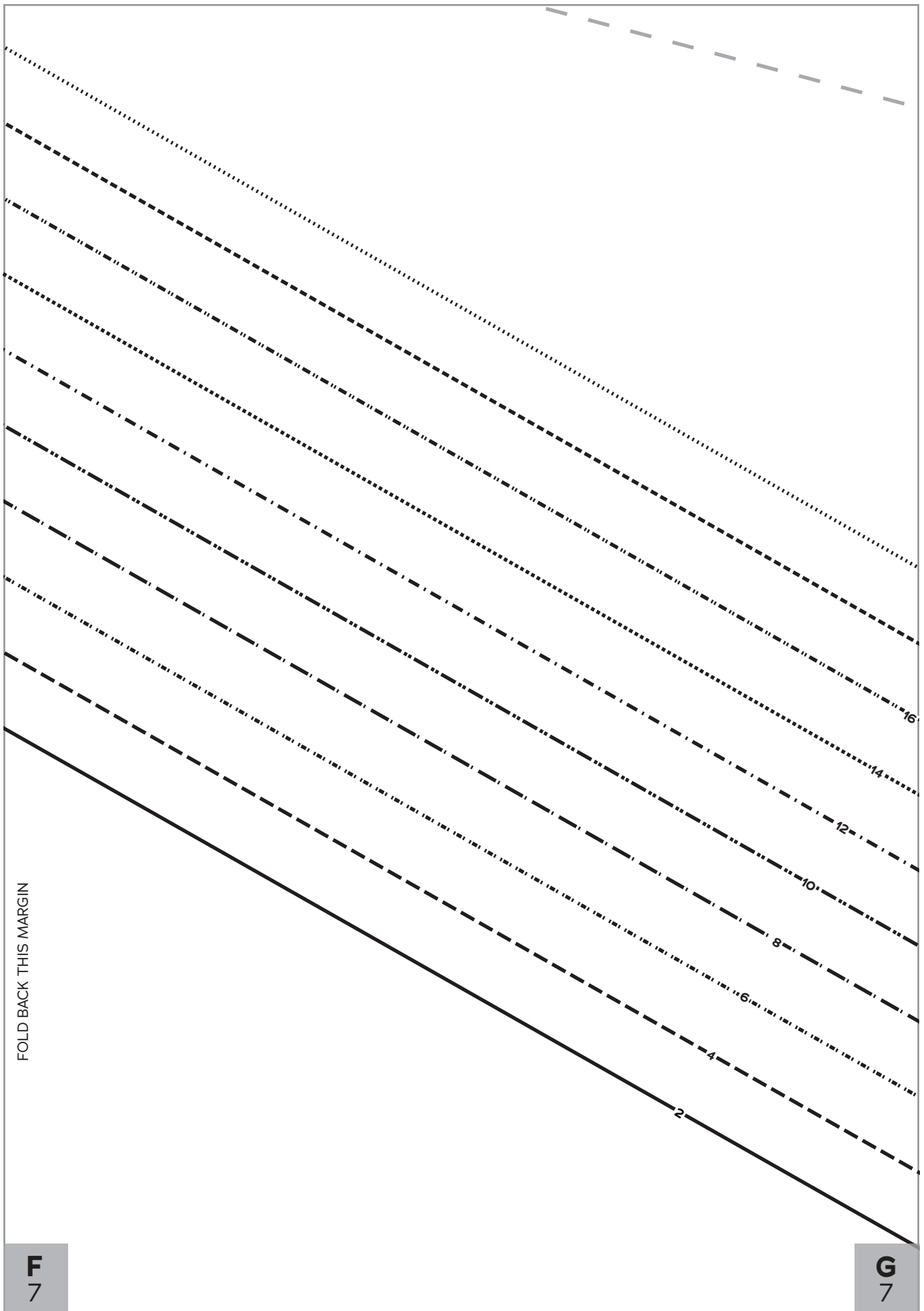

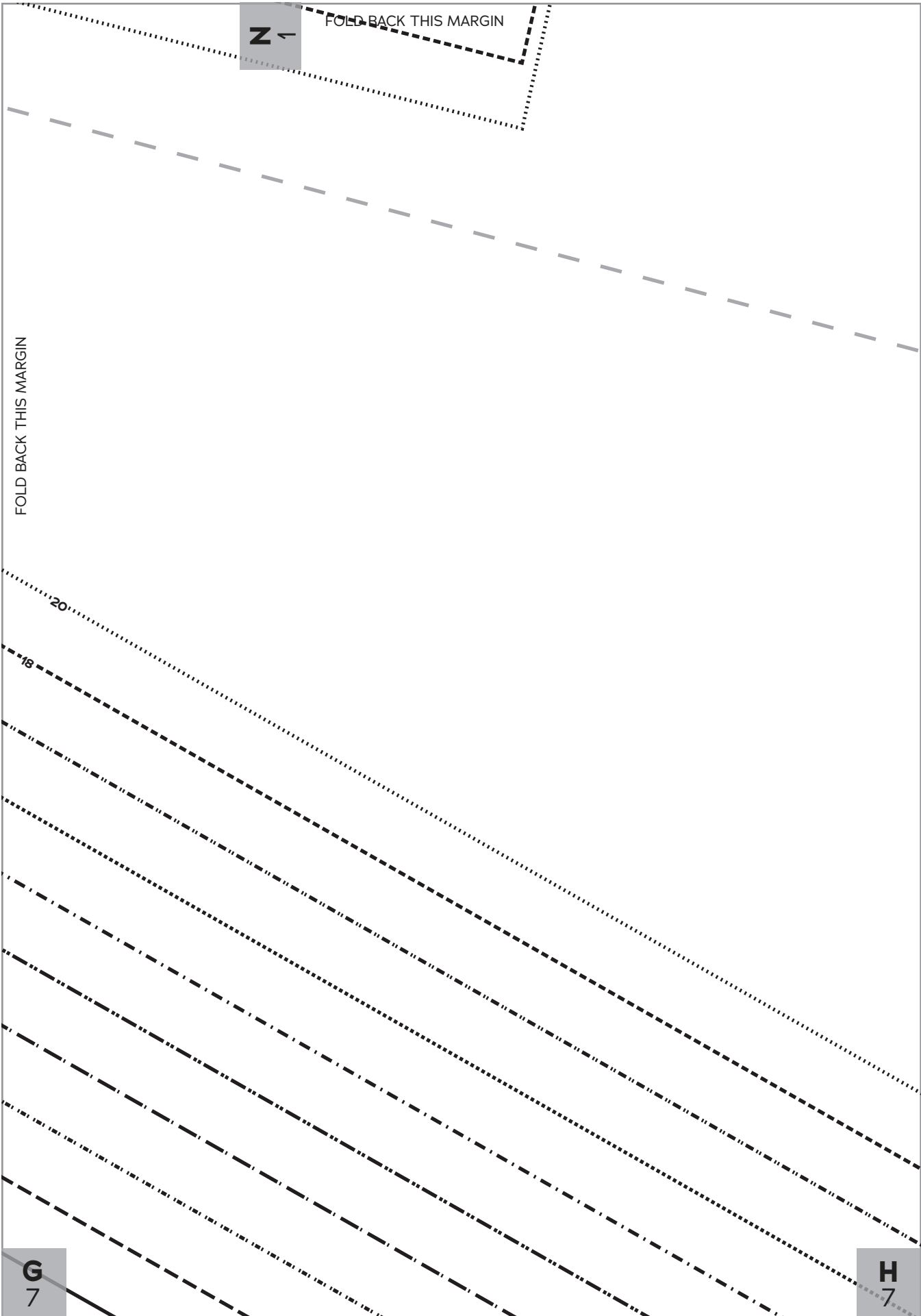

FOLD BACK THIS MARGIN

H
7

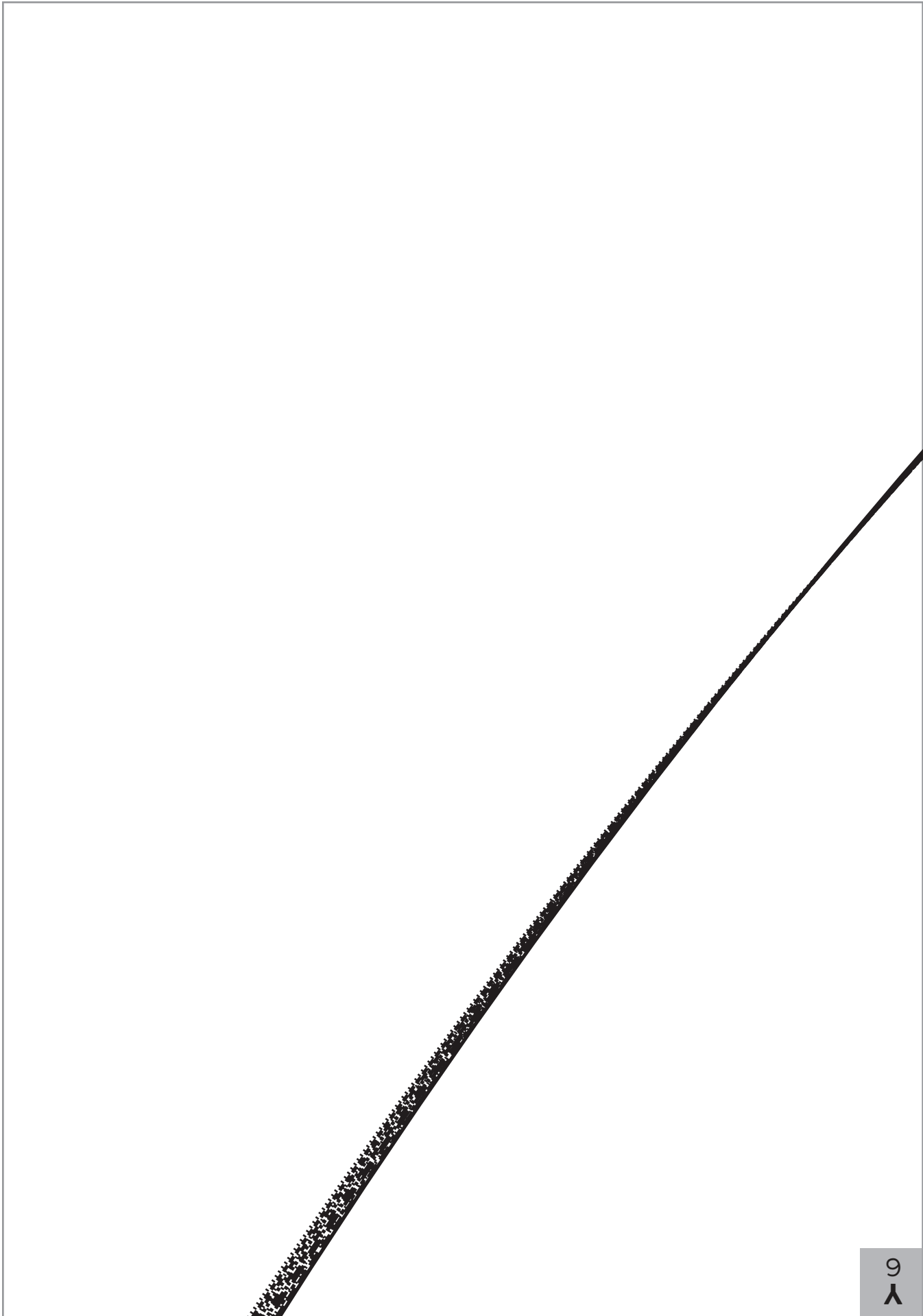

9
A

FOLD BACK THIS MARGIN

9
FF

FOLD BACK THIS MARGIN

9
A

9
X

9

FF

FOLD BACK THIS MARGIN

9

EE

FOLD BACK THIS MARGIN

9

X

9

M

9
EE

FOLD BACK THIS MARGIN

9
DD

FOLD BACK THIS MARGIN

9
MM

9
NN

9
DD

FOLD BACK THIS MARGIN

9
CC

FOLD BACK THIS MARGIN

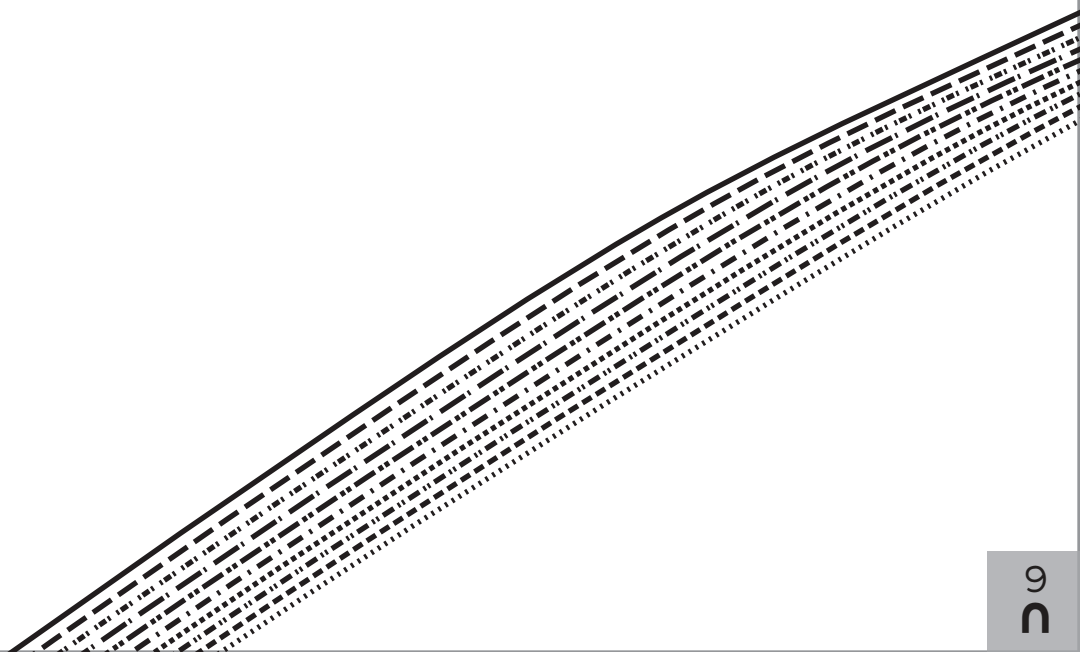

9
A

9
U

9
CC

FOLD BACK THIS MARGIN

9
BB

FOLD BACK THIS MARGIN

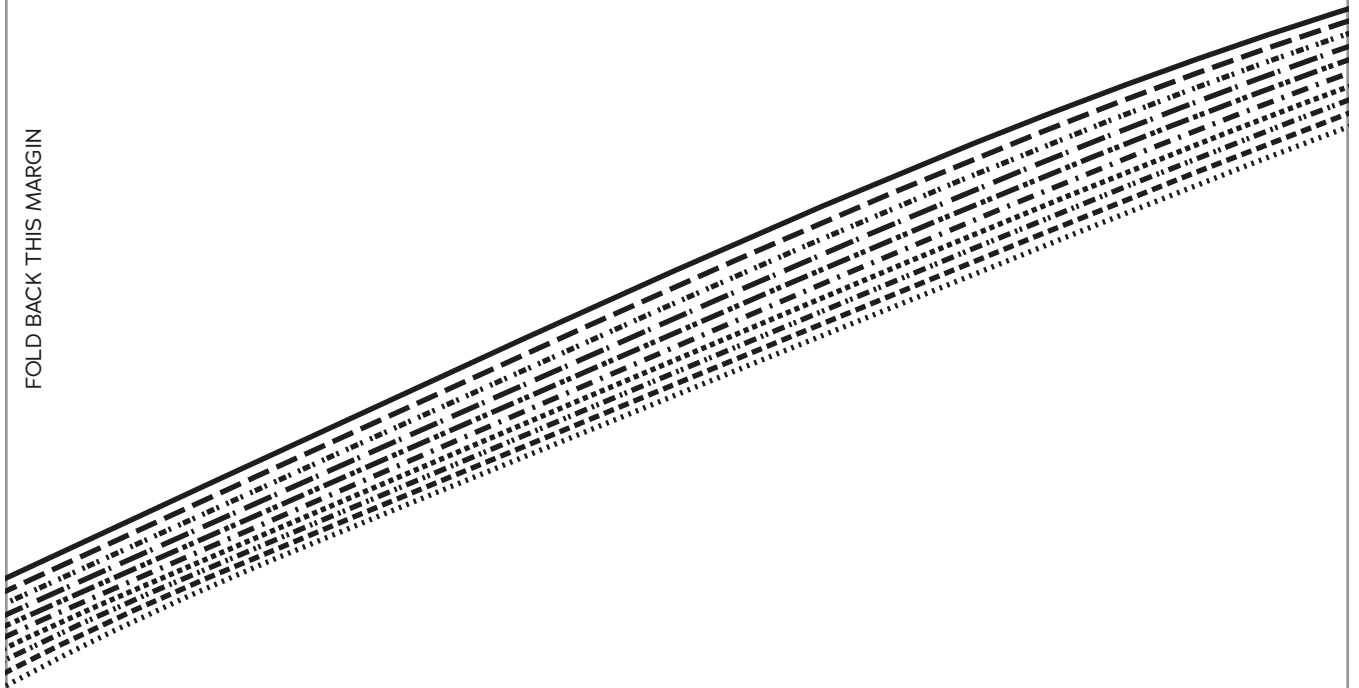

9
CC

9
BB

9
BB

FOLD BACK THIS MARGIN

9
AA

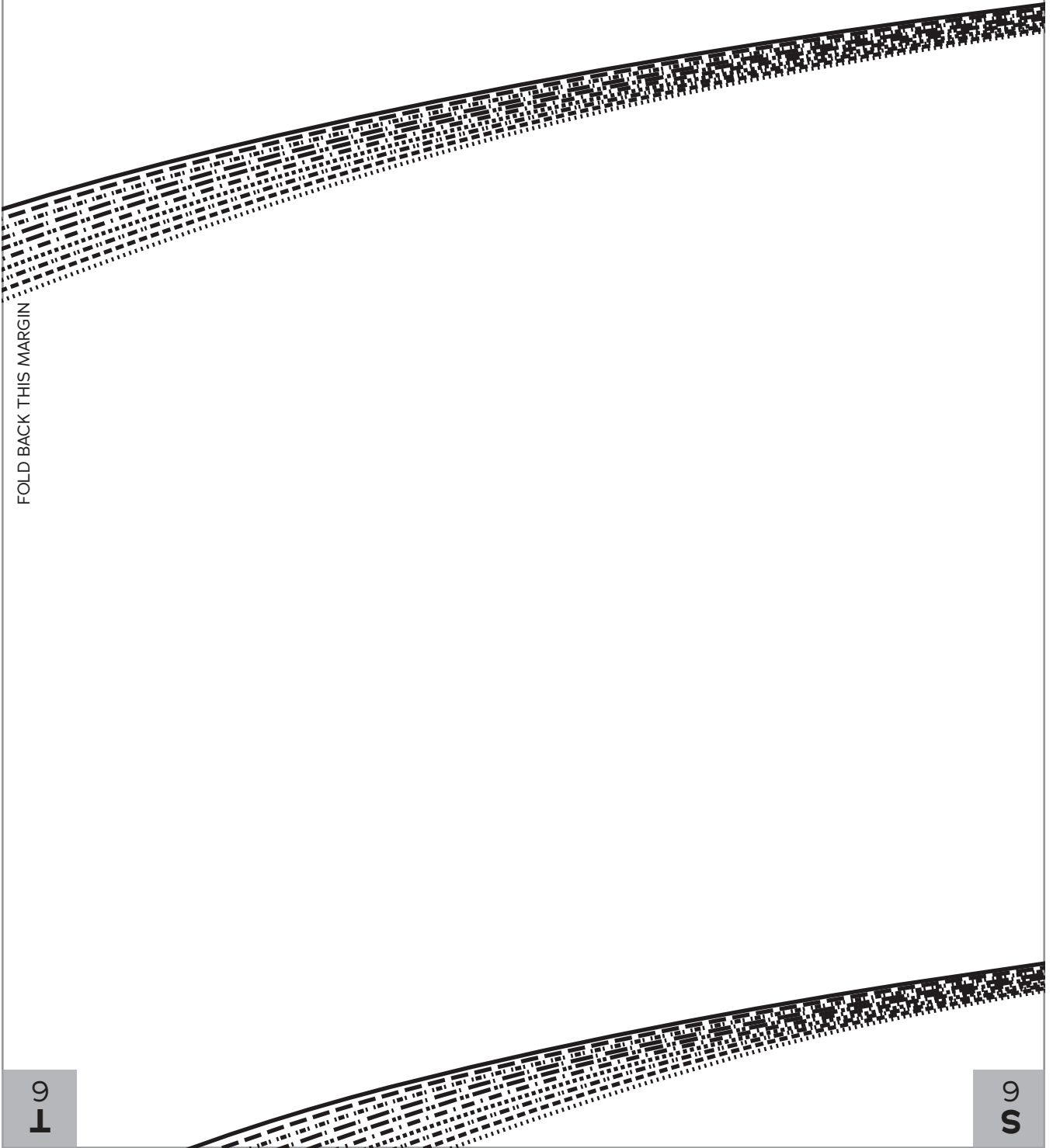

FOLD BACK THIS MARGIN

9
1

9
S

9
AA

FOLD BACK THIS MARGIN

9
Z

FOLD BACK THIS MARGIN

9
S

9
R

9

FOLD
BACK
THIS
MARGIN

FOLD BACK
THIS MARGIN

C
7

FOLD BACK THIS MARGIN

9

I
7

C
7

FOLD BACK THIS MARGIN

D
7

FOLD BACK THIS MARGIN

I
7

J
7

D
7

FOLD BACK THIS MARGIN

E
7

FOLD BACK THIS MARGIN



**FRENCHY
PEIGNOIR
SET**

SIZES 2-20

7

Robe
Back

Cut 1 fabric on fold

J
7

K
7

E
7

FOLD BACK THIS MARGIN

F
7

FOLD BACK THIS MARGIN

K
7

L
7

F
7

FOLD BACK THIS MARGIN

G
7

FOLD BACK THIS MARGIN

L
7

M
7

G
7

FOLD BACK THIS MARGIN

H
7

FOLD BACK THIS MARGIN

M
7

N
7

H
7

FOLD BACK THIS MARGIN

FOLD BACK THIS MARGIN

N
7

O
7

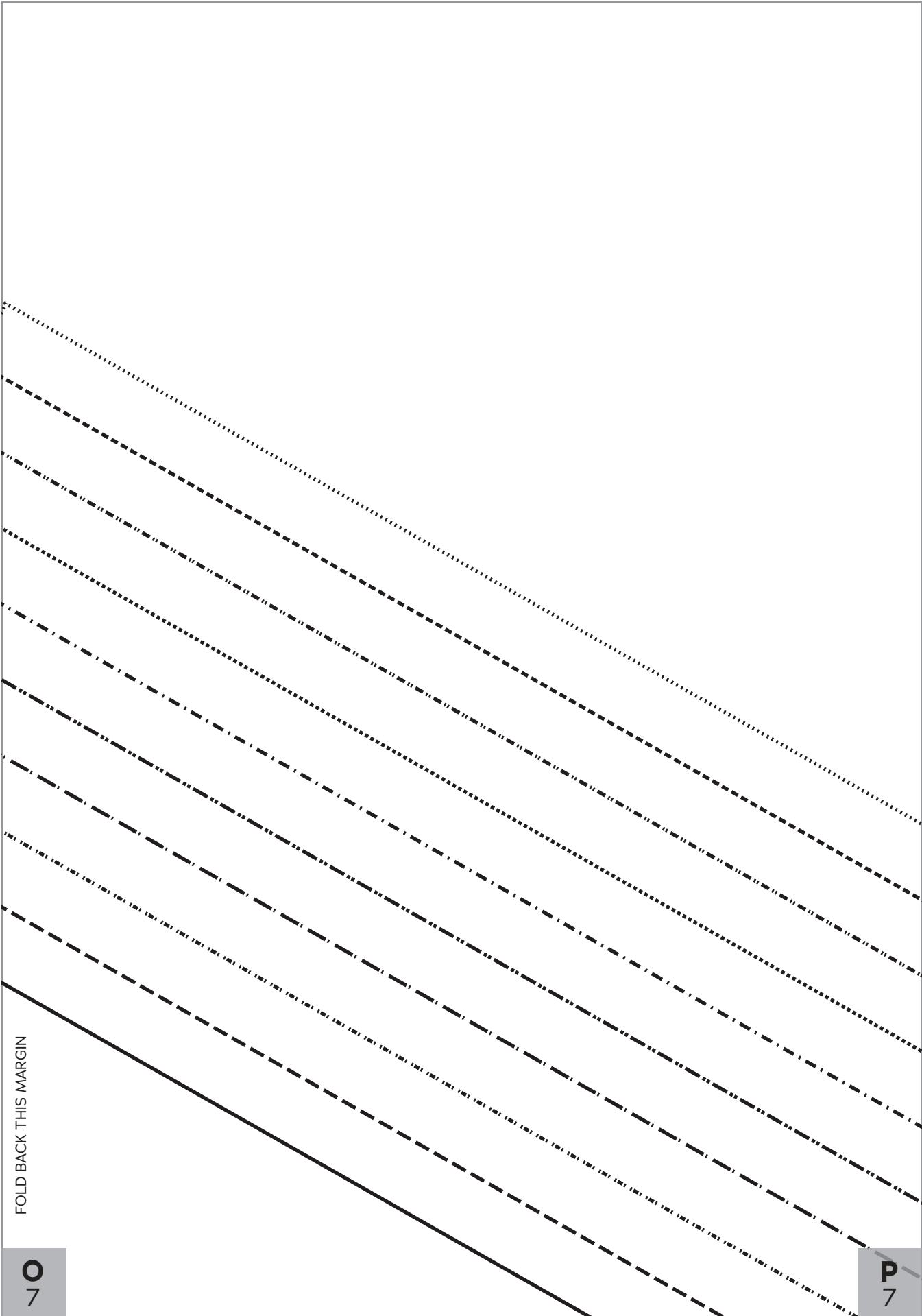

FOLD BACK THIS MARGIN

O
7

P
7

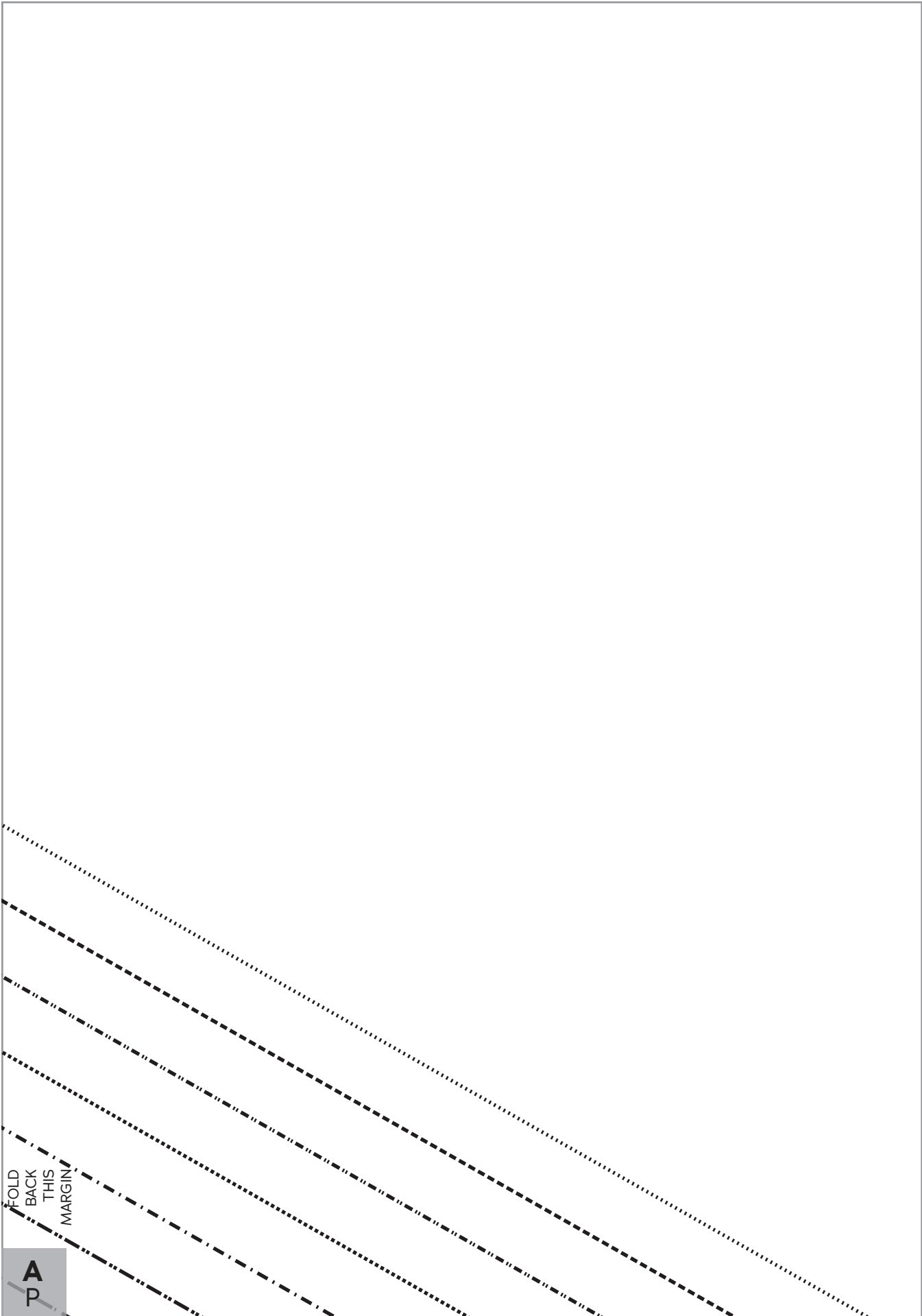

FOLD
BACK
THIS
MARGIN

A
P

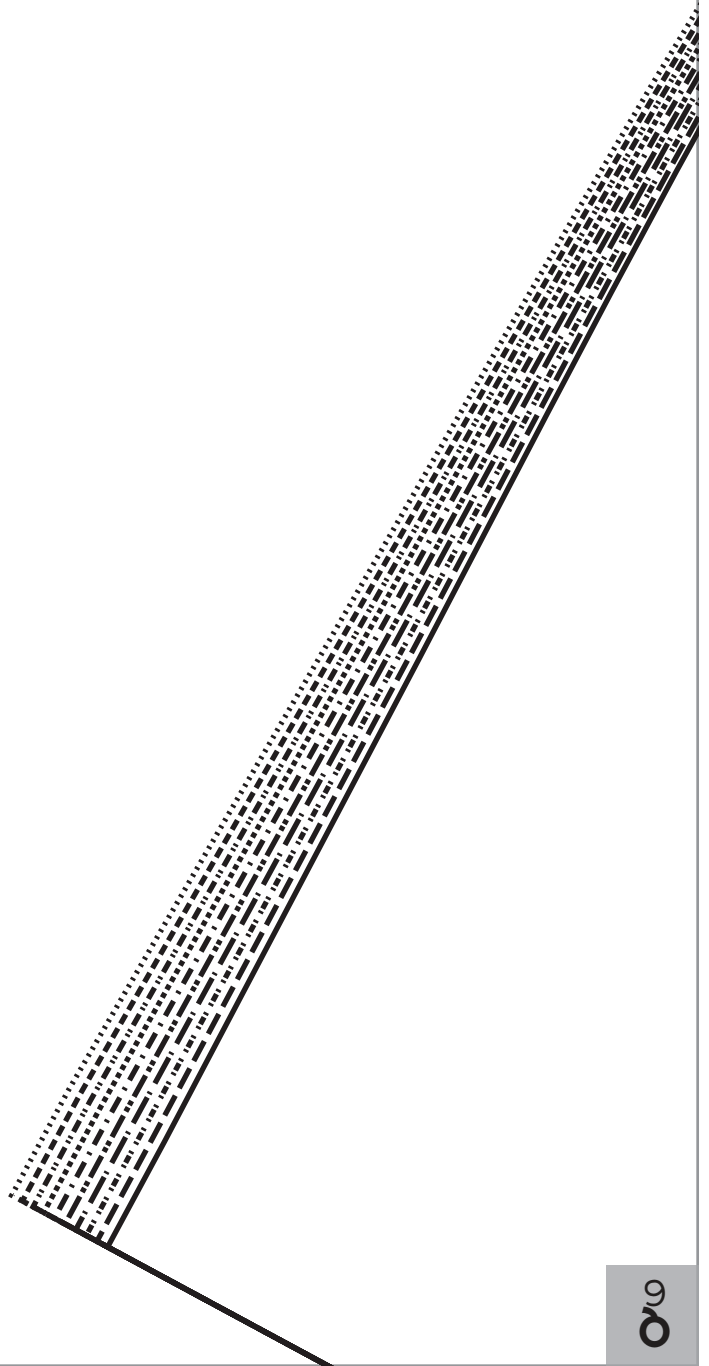

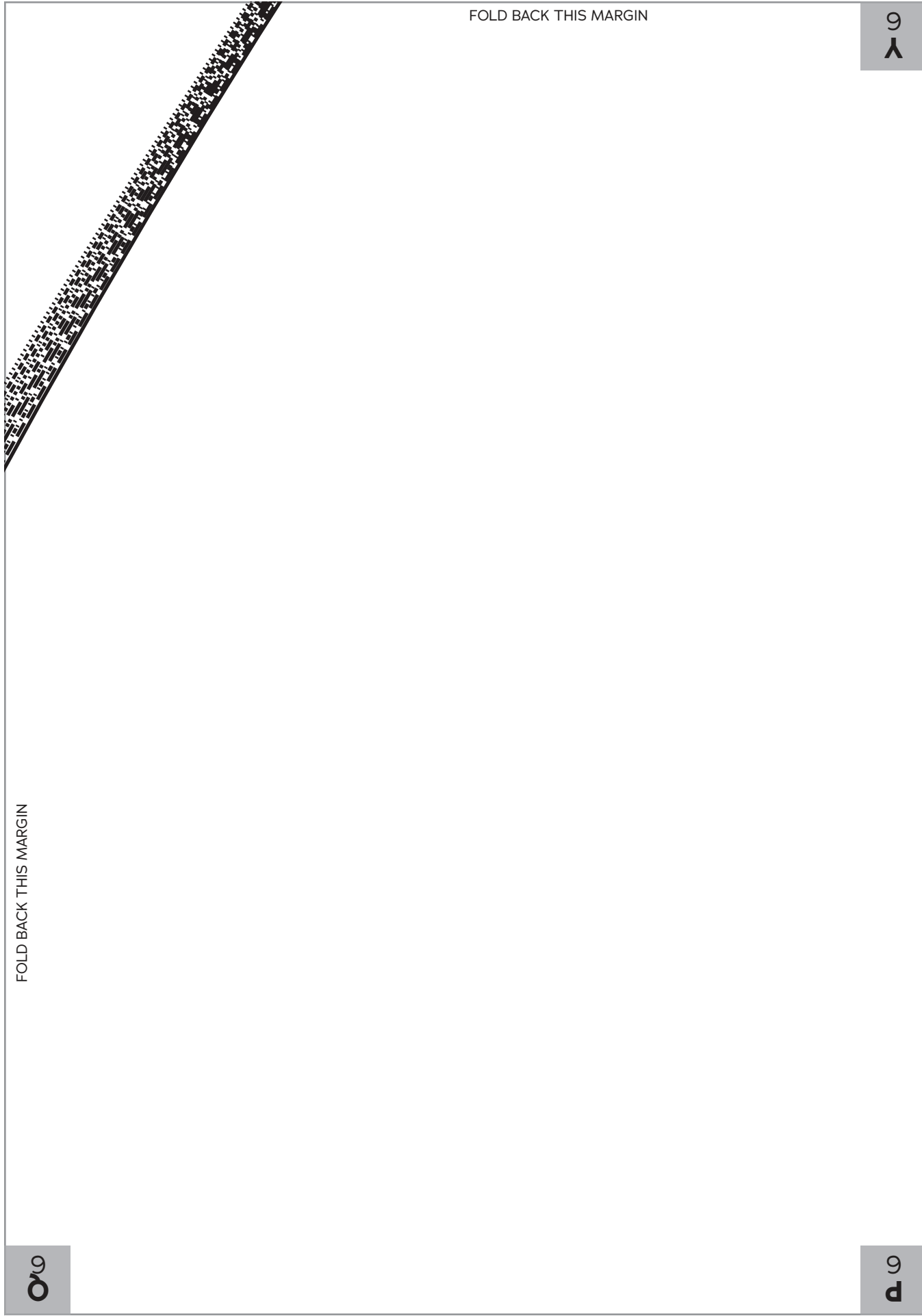

FOLD BACK THIS MARGIN

9
A

FOLD BACK THIS MARGIN

9
A

9
A

9
A

FOLD BACK THIS MARGIN

9
X

FOLD BACK THIS MARGIN

9
B

9
O

9
X

FOLD BACK THIS MARGIN

9
M

FOLD BACK THIS MARGIN

9
O

9
N

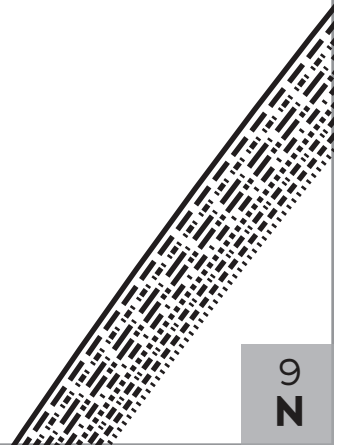

9
M

FOLD BACK THIS MARGIN

9
A

FOLD BACK THIS MARGIN

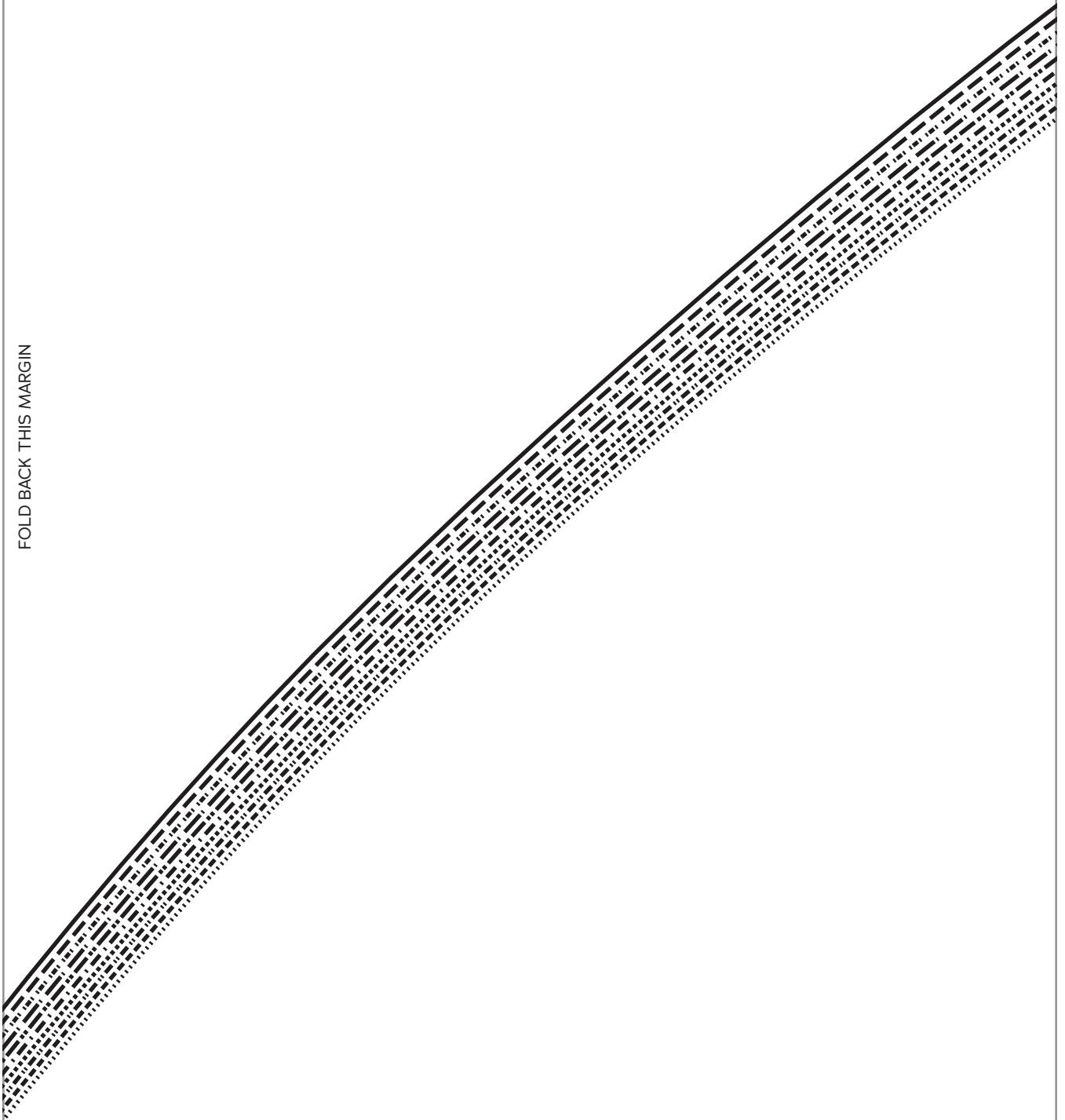

9
Z

9
W

9
^

FOLD BACK THIS MARGIN

9
n

FOLD BACK THIS MARGIN

9
W

9
l

9

FOLD BACK THIS MARGIN

9

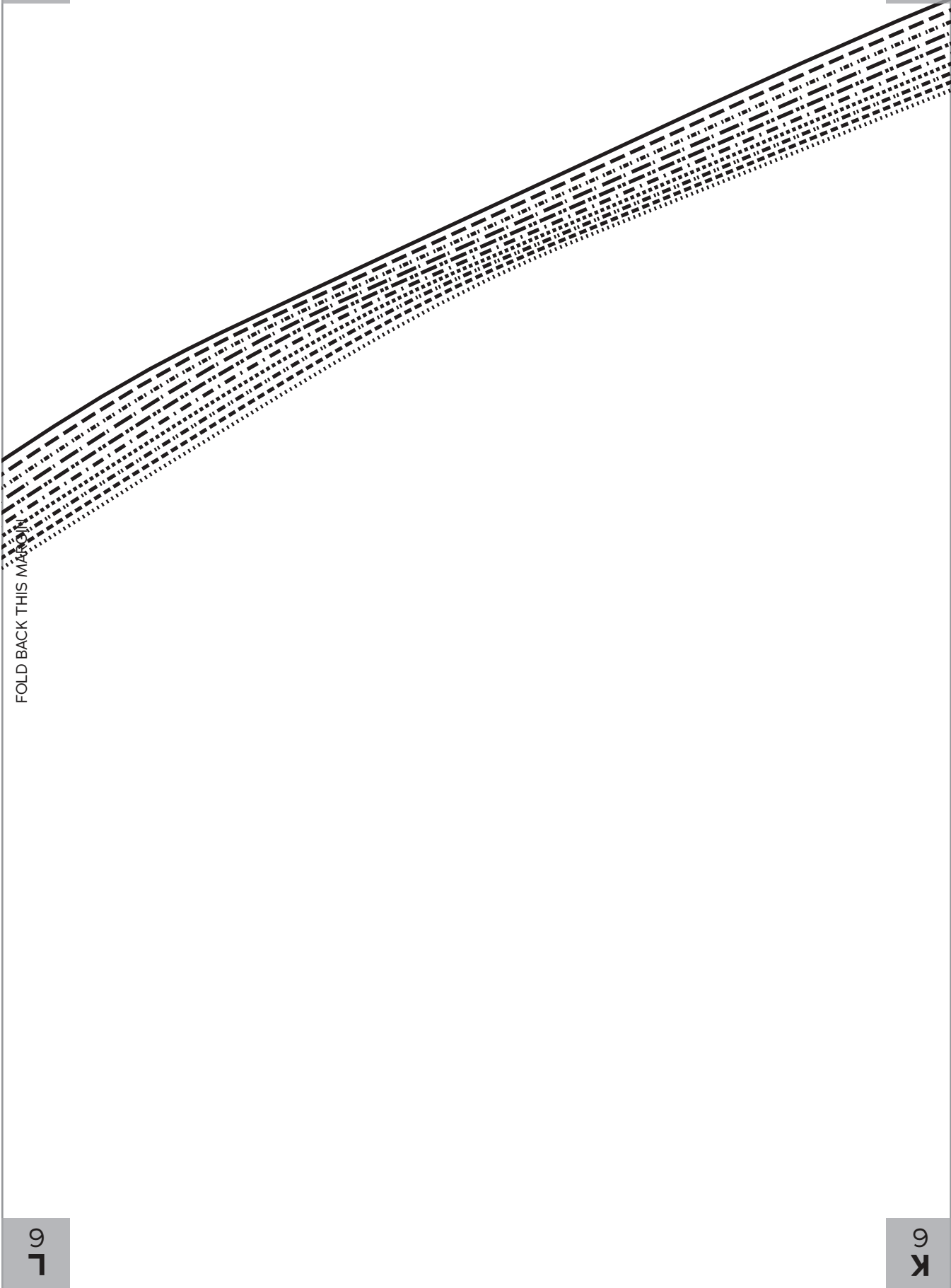

FOLD BACK THIS MARGIN

9

9

9

FOLD BACK THIS MARGIN

9

S

FOLD BACK THIS MARGIN

9

K

9

J

5

FOLD BACK THIS MARGIN

6

FOLD BACK THIS MARGIN

2

4

5

6

29

FOLD
BACK
THIS
MARGIN

FOLD BACK THIS MARGIN

6

8

10

12

14

16

18

20

FOLD BACK
THIS MARGIN

7

FOLD

9

30

I
7

FOLD BACK THIS MARGIN

J
7

FOLD BACK THIS MARGIN

O
7

R
7

J
7

FOLD BACK THIS MARGIN

K
7

FOLD BACK THIS MARGIN

R
7

S
7

K
7

FOLD BACK THIS MARGIN

L
7

FOLD BACK THIS MARGIN

S
7

T
7

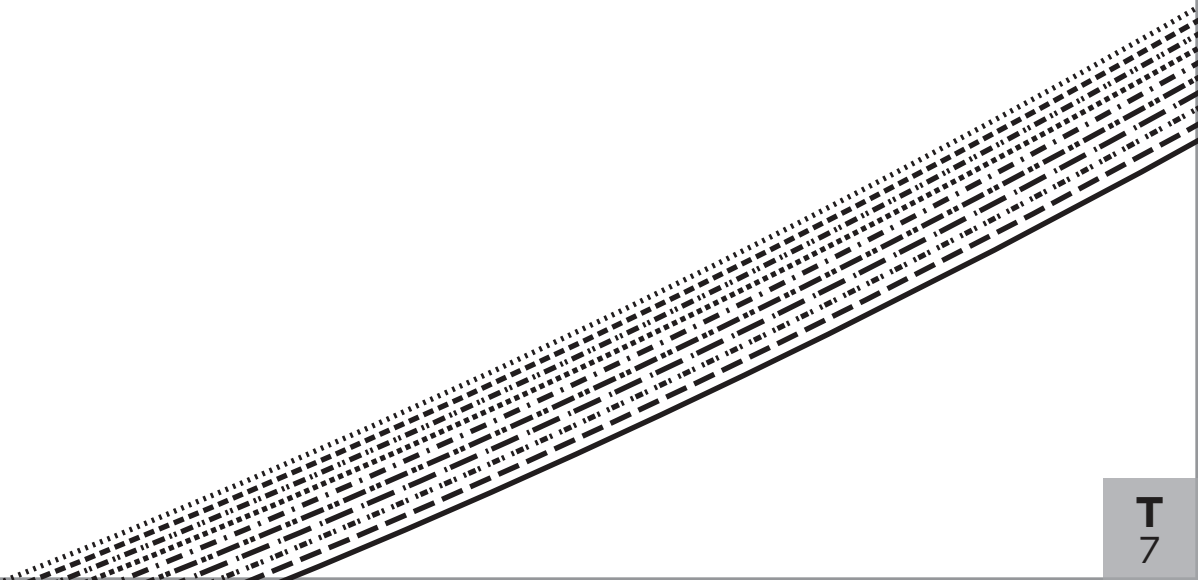

L
7

FOLD BACK THIS MARGIN

M
7

FOLD BACK THIS MARGIN

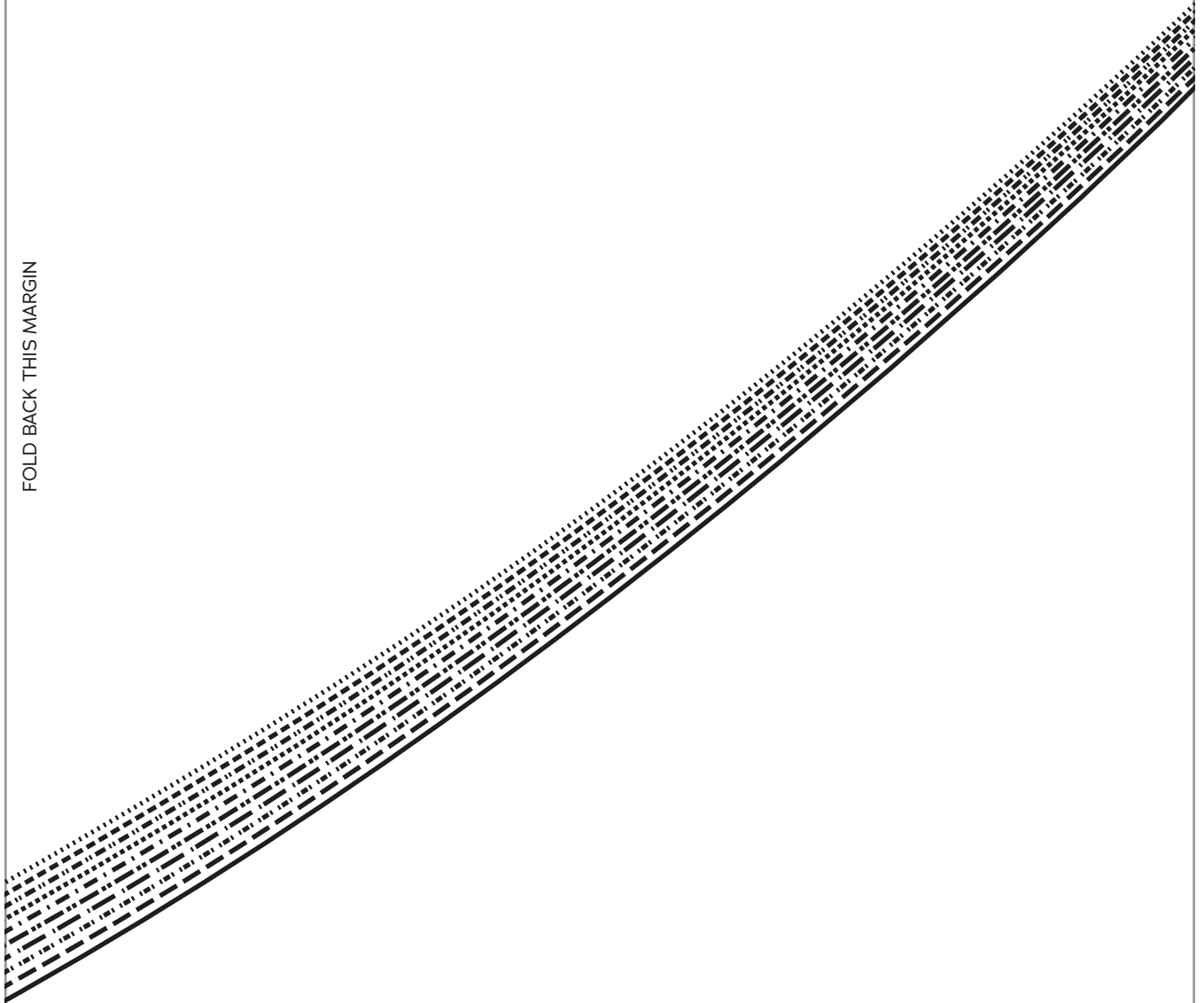

T
7

U
7

M
7

FOLD BACK THIS MARGIN

N
7

FOLD BACK THIS MARGIN

U
7

V
7

N
7

FOLD BACK THIS MARGIN

O
7

FOLD BACK THIS MARGIN

V
7

W
7

O
7

FOLD BACK THIS MARGIN

P
7

FOLD BACK THIS MARGIN

W
7

X
7

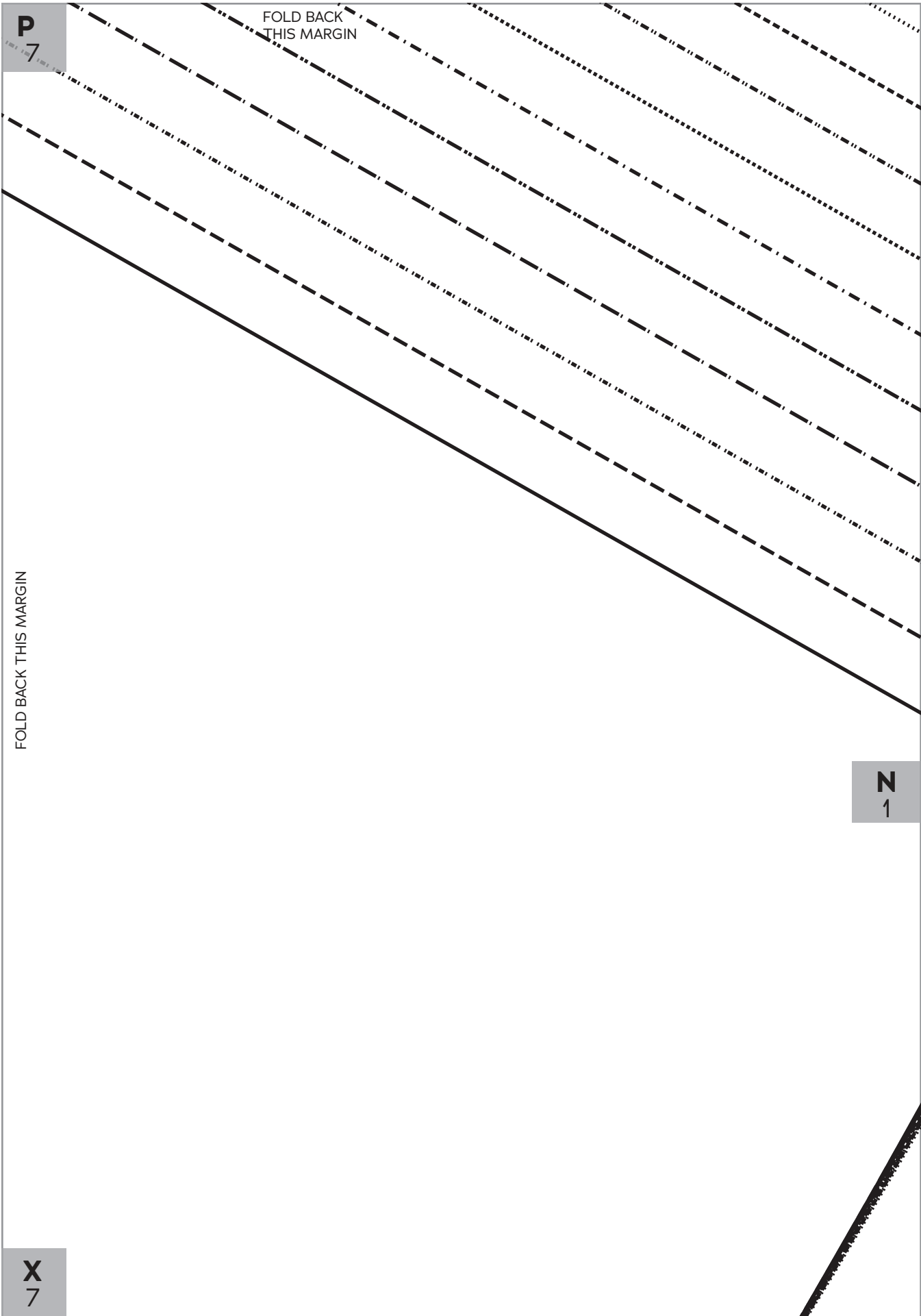

FOLD BACK THIS MARGIN

FOLD BACK THIS MARGIN

P
7

N
1

X
7

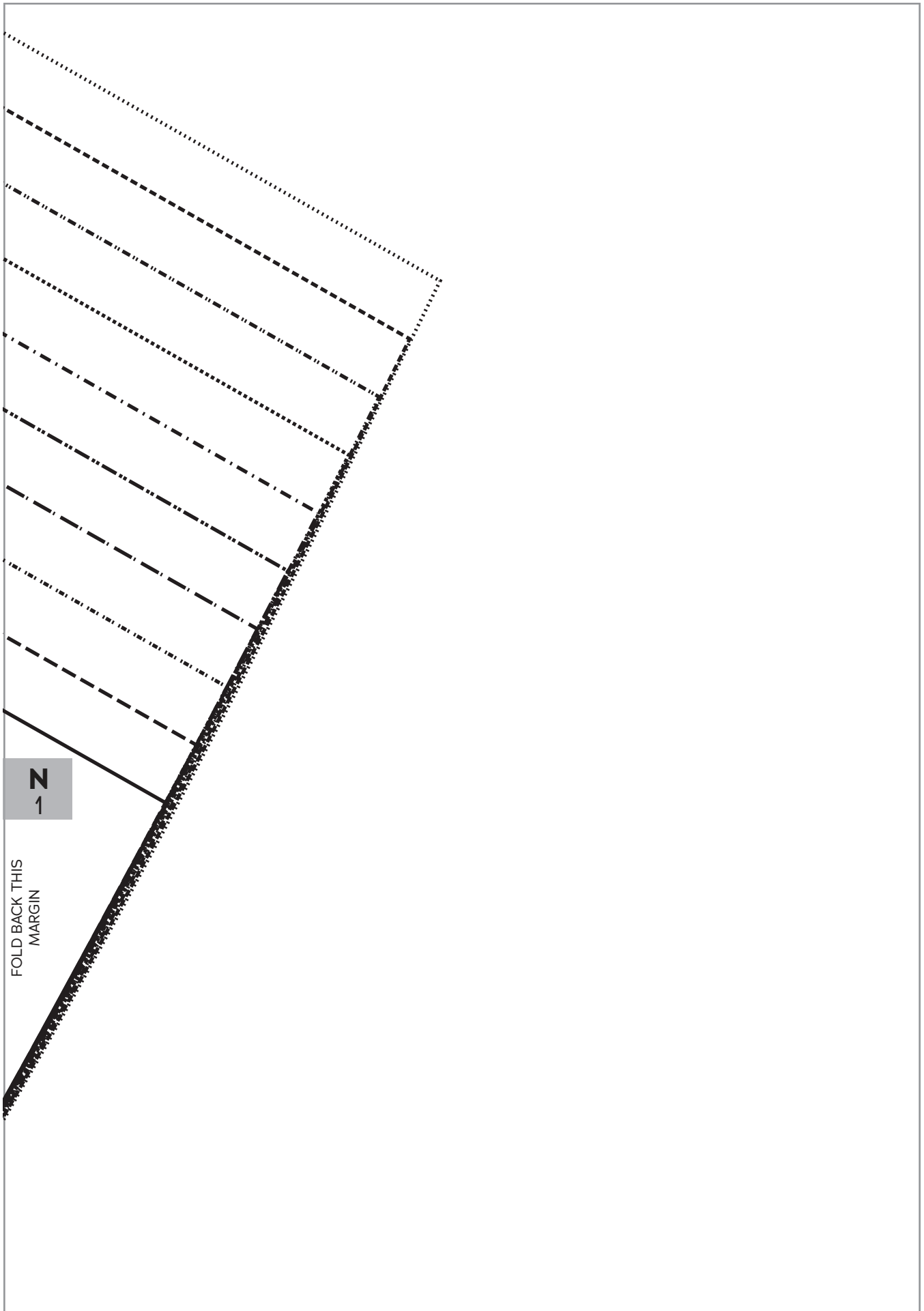

FOLD BACK
THIS MARGIN





FOLD BACK THIS MARGIN



FOLD
BACK
THIS
MARGIN

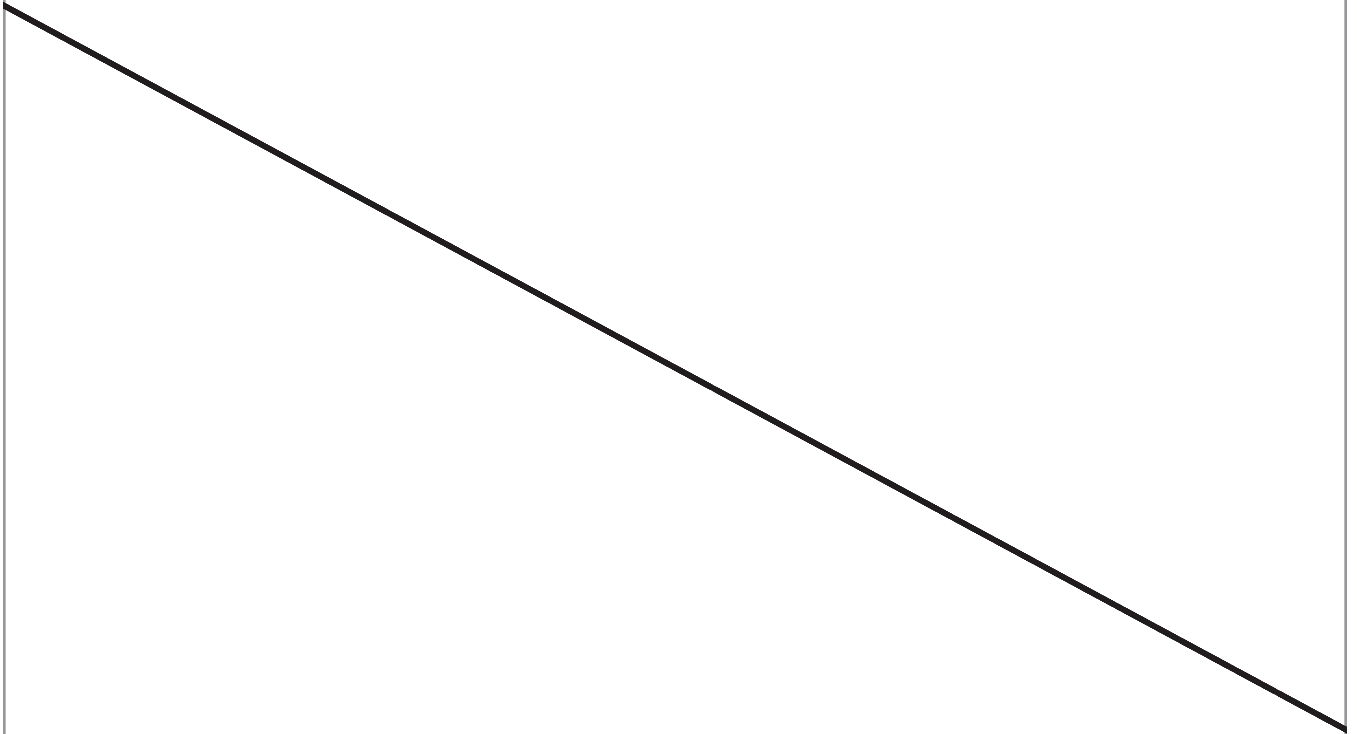

FOLD BACK THIS MARGIN

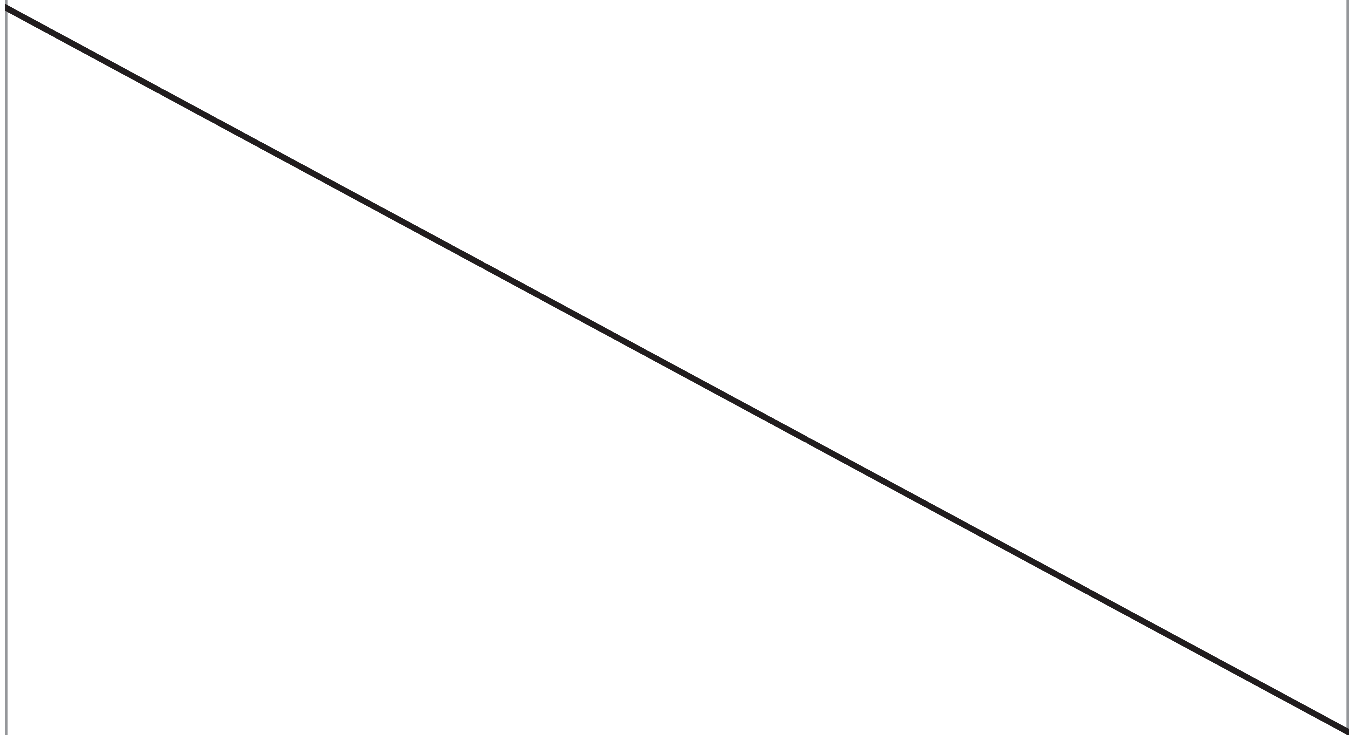

00

FOLD BACK THIS MARGIN

02

FOLD BACK THIS MARGIN

KNEE-LENGTH CUTTING LINE

09

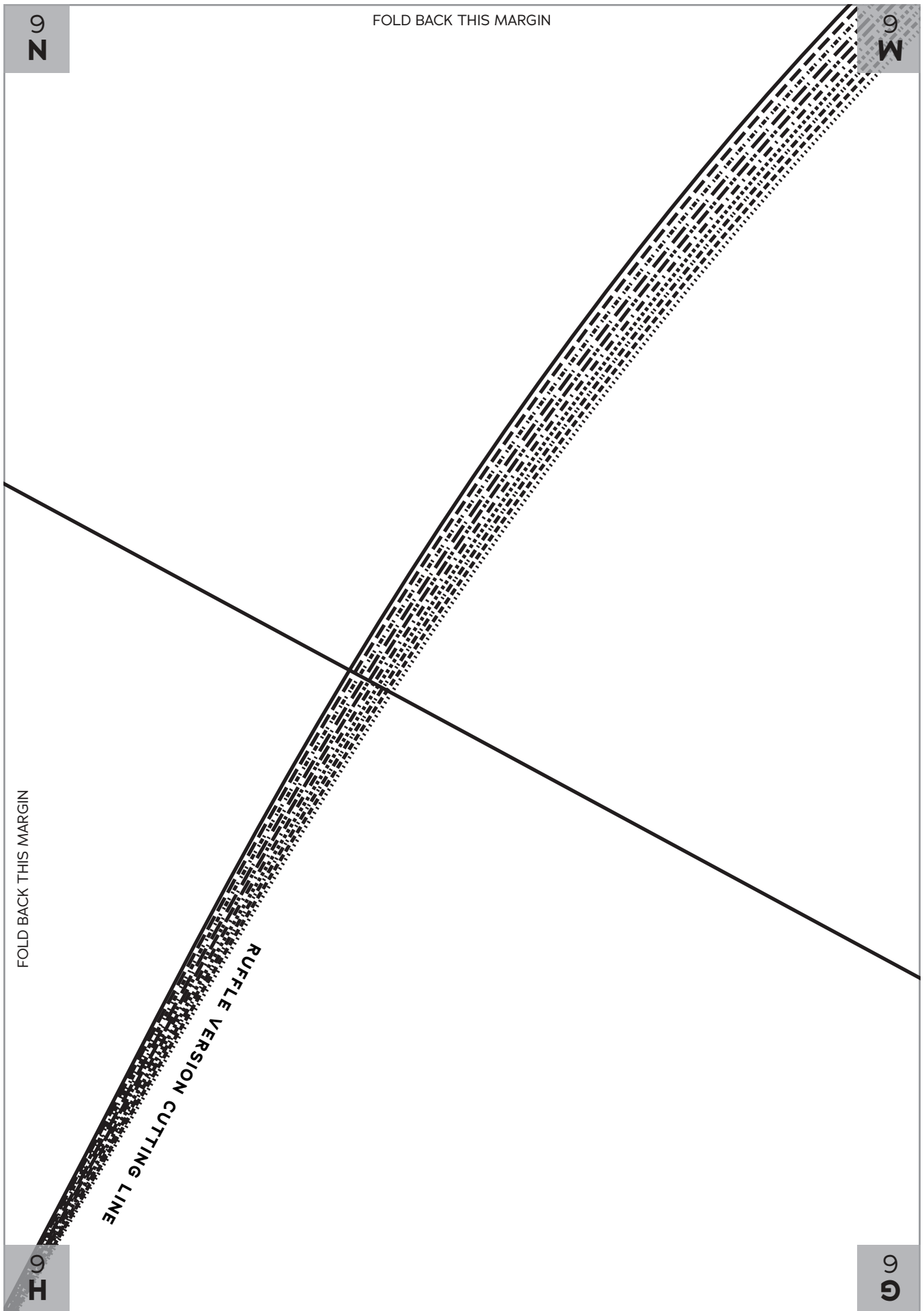

9

FOLD BACK THIS MARGIN

9
W

FOLD BACK THIS MARGIN

RUFFLE VERSION CUTTING LINE

9
H

9
G

9
W

FOLD BACK THIS MARGIN

9
7

FOLD BACK THIS MARGIN

GRAINLINE

9
G

9
7

FOLD BACK THIS MARGIN

6 L

6 K

FOLD BACK THIS MARGIN

Robe
Front
Cut 2 fabric

6

**CHARM
ARTIST
COLLECTIVE**
**FRENCHY
PEIGNOIR
SET**
SIZES 2-20



6 T

6 F

9
K

FOLD BACK THIS MARGIN

9
1

FOLD BACK THIS MARGIN

9
M

9
D



FOLD BACK THIS MARGIN



FOLD BACK THIS MARGIN



9

FOLD
BACK
THIS
MARGIN

FOLD BACK
THIS MARGIN

9
7

FOLD BACK THIS MARGIN

RUFFLE VERSION

KNEE-LENGTH CU

9

Y
7

Q
7

FOLD BACK THIS MARGIN

R
7

CUTTING LINE

FOLD BACK THIS MARGIN

CUTTING LINE

Y
7

Z
7

R
7

FOLD BACK THIS MARGIN

S
7

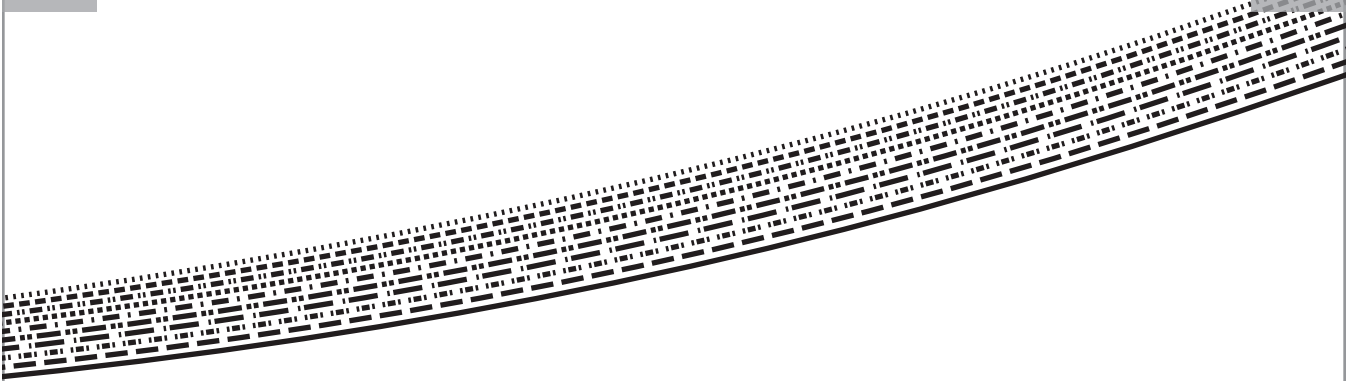

FOLD BACK THIS MARGIN

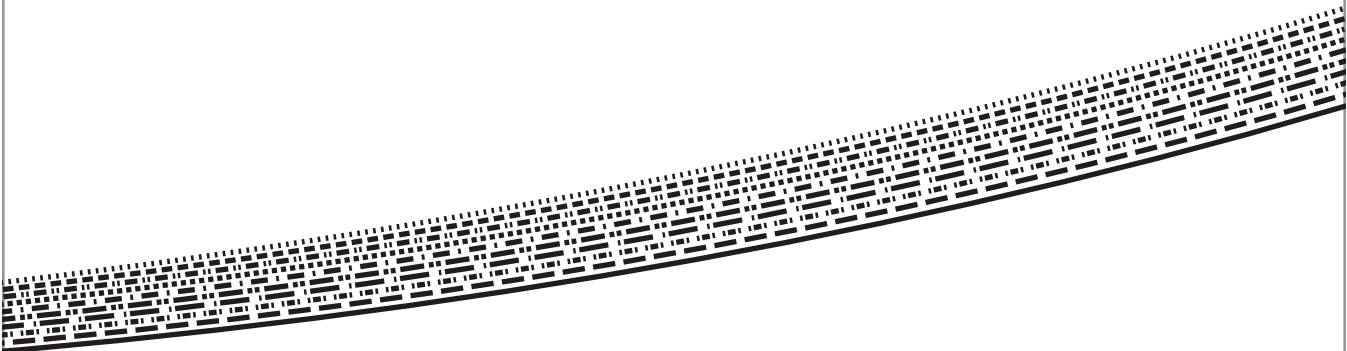

Z
7

AA
7

S
7

FOLD BACK THIS MARGIN

T
7

FOLD BACK THIS MARGIN

AA
7

BB
7

T
7

FOLD BACK THIS MARGIN

U
7

FOLD BACK THIS MARGIN

BB
7

CC
7



FOLD BACK THIS MARGIN



FOLD BACK THIS MARGIN



V
7

FOLD BACK THIS MARGIN

W
7

FOLD BACK THIS MARGIN

DD
7

EE
7

W
7

FOLD BACK THIS MARGIN

X
7

FOLD BACK THIS MARGIN

EE
7

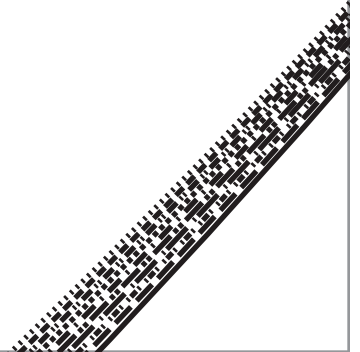

X
7

FOLD BACK THIS MARGIN

FOLD BACK THIS MARGIN

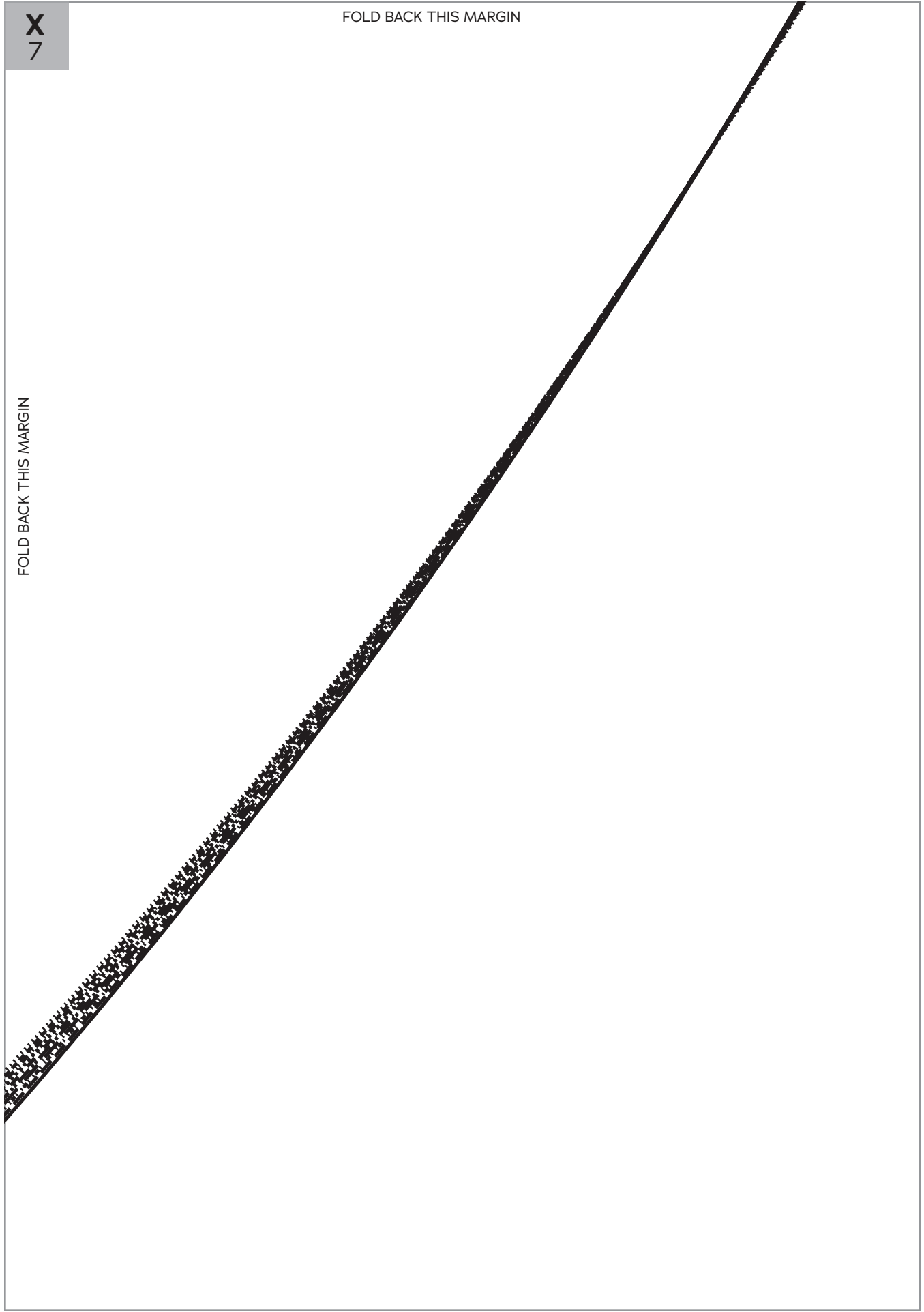

FOLD BACK THIS MARGIN

9
H

H

FOLD BACK THIS MARGIN

G

FOLD BACK THIS MARGIN

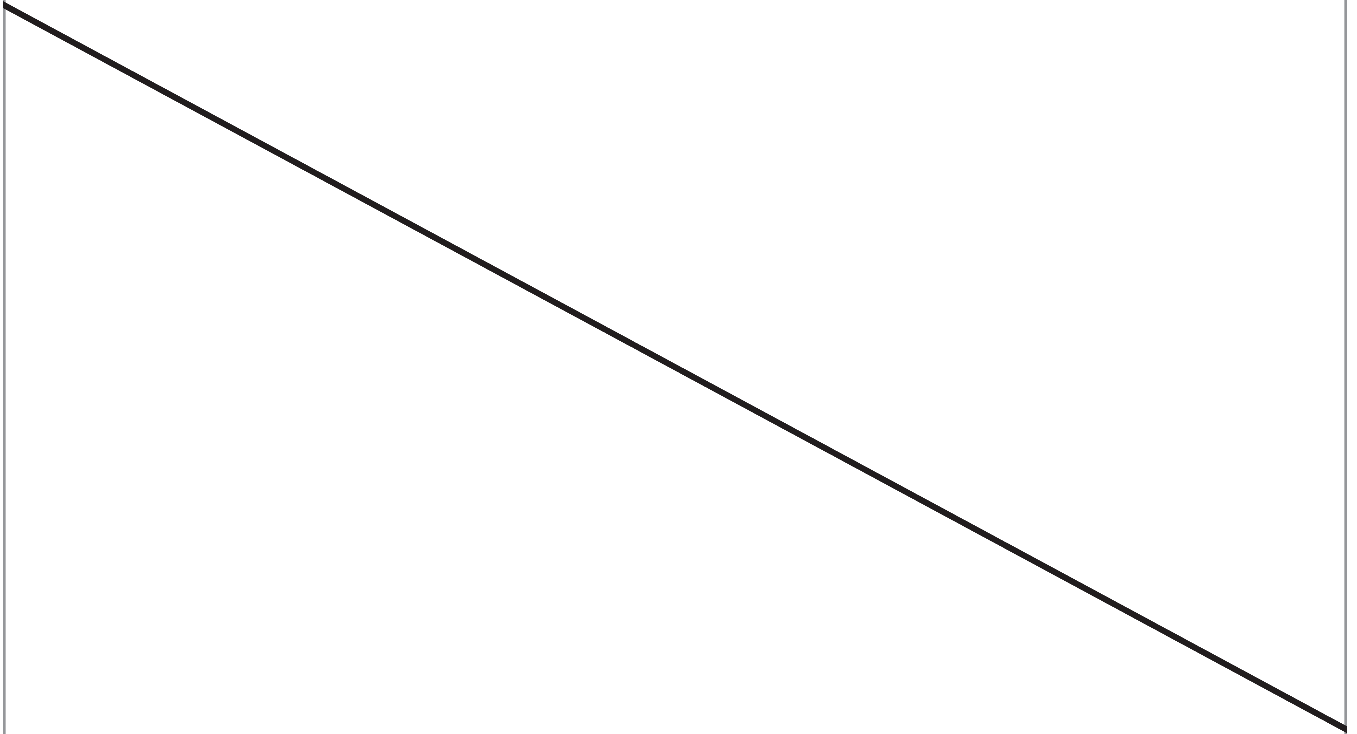

6

FOLD BACK THIS MARGIN

6

FOLD BACK THIS MARGIN

9
F

FOLD BACK THIS MARGIN

9
F

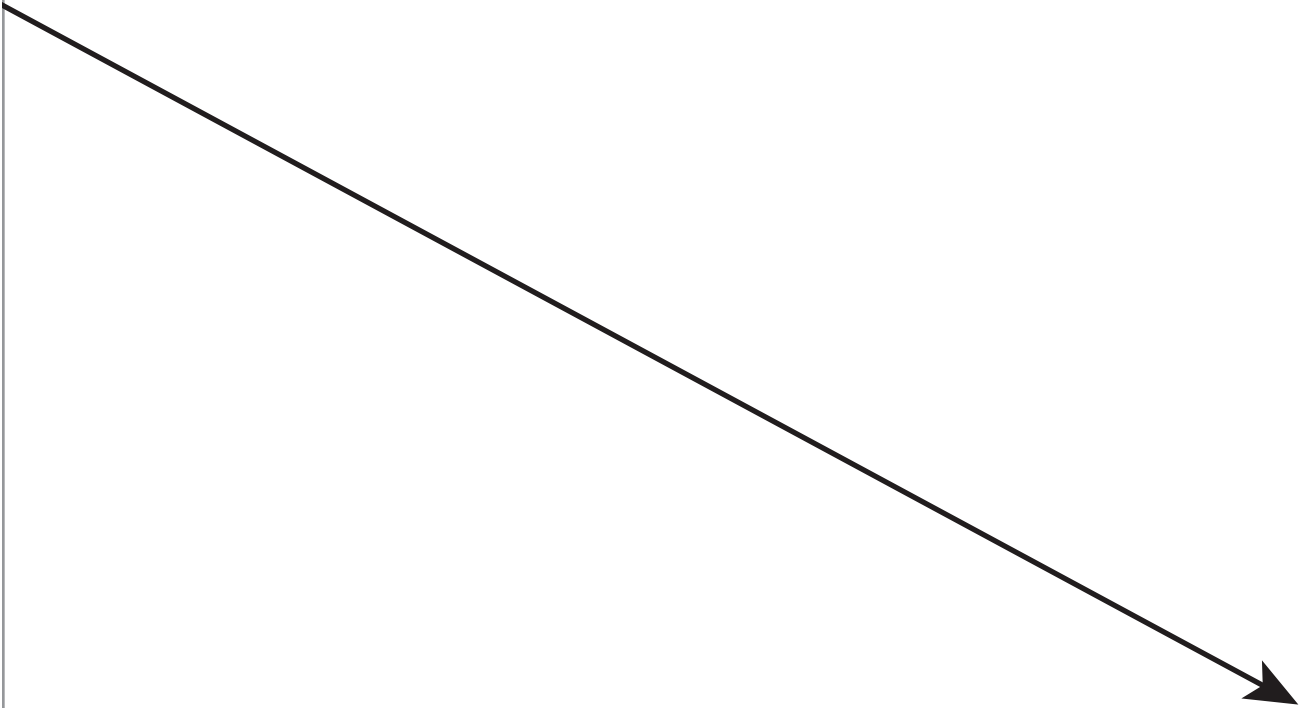

FOLD BACK THIS MARGIN

9
F

9
E

FOLD BACK THIS MARGIN

9
D

FOLD BACK THIS MARGIN

9
B

9
A

FOLD BACK THIS MARGIN



FOLD BACK THIS MARGIN

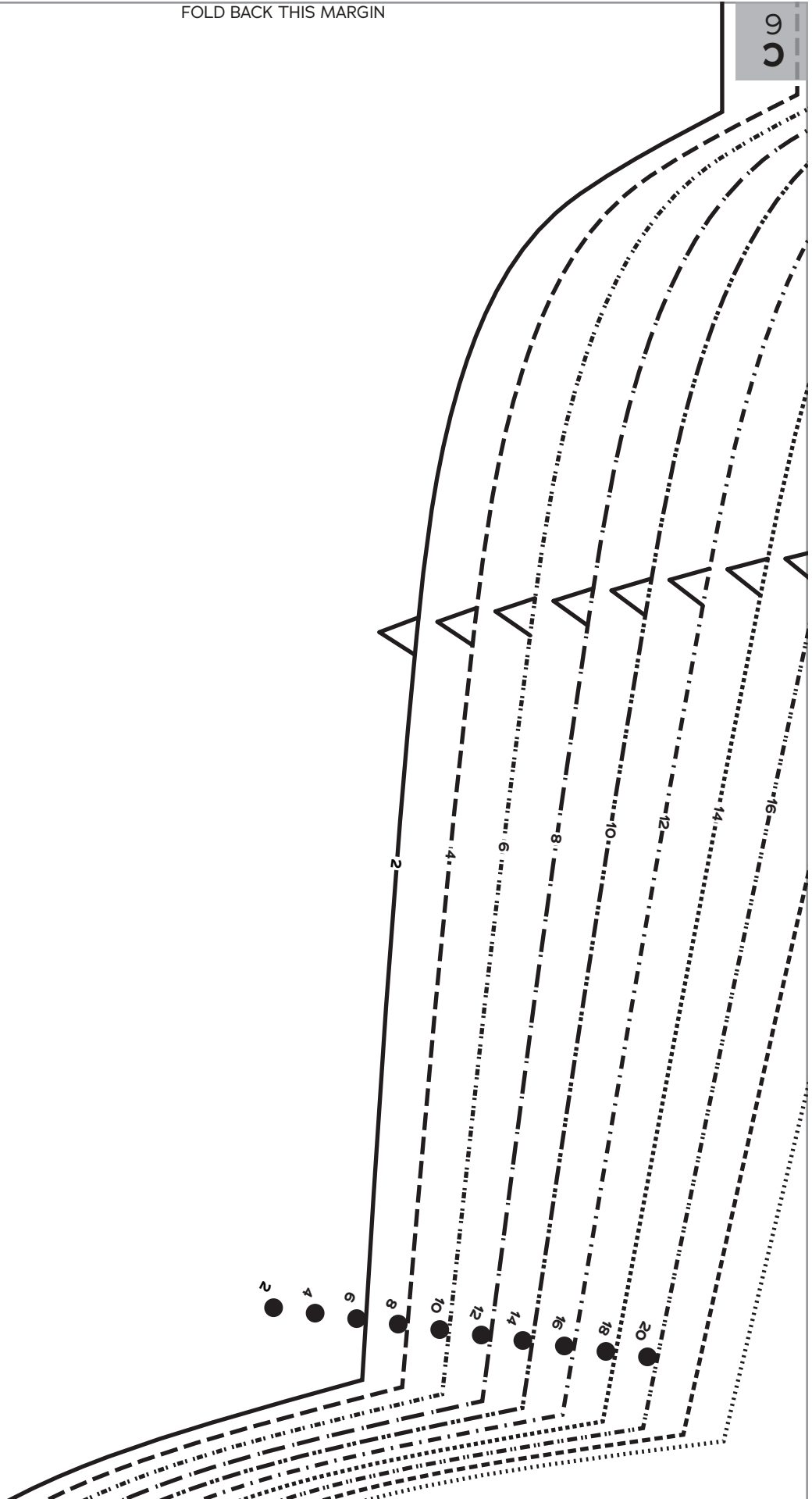

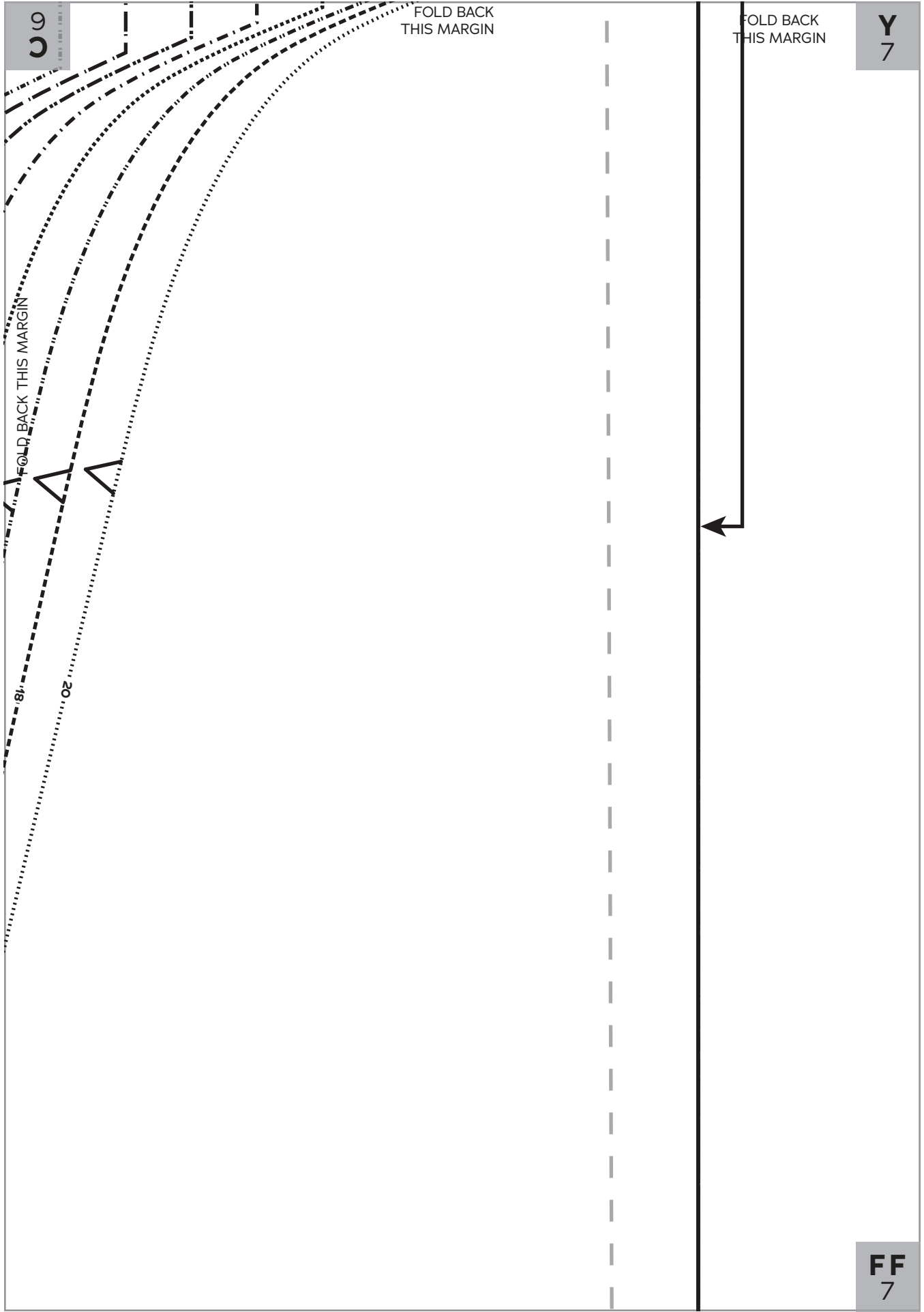

Y
7

FOLD BACK THIS MARGIN

Z
7

FOLD BACK THIS MARGIN

FF
7

GG
7

Z
7

FOLD BACK THIS MARGIN

AA
7

FOLD BACK THIS MARGIN

GG
7

HH
7

AA
7

FOLD BACK THIS MARGIN

BB
7

FOLD BACK THIS MARGIN

HH
7

II
7

BB
7

FOLD BACK THIS MARGIN

CC
7

FOLD BACK THIS MARGIN

II
7

JJ
7

CC
7

FOLD BACK THIS MARGIN

DD
7

FOLD BACK THIS MARGIN

JJ
7



DD
7

FOLD BACK THIS MARGIN

EE
7

FOLD BACK THIS MARGIN



EE
7

FOLD BACK THIS MARGIN

FOLD BACK THIS MARGIN

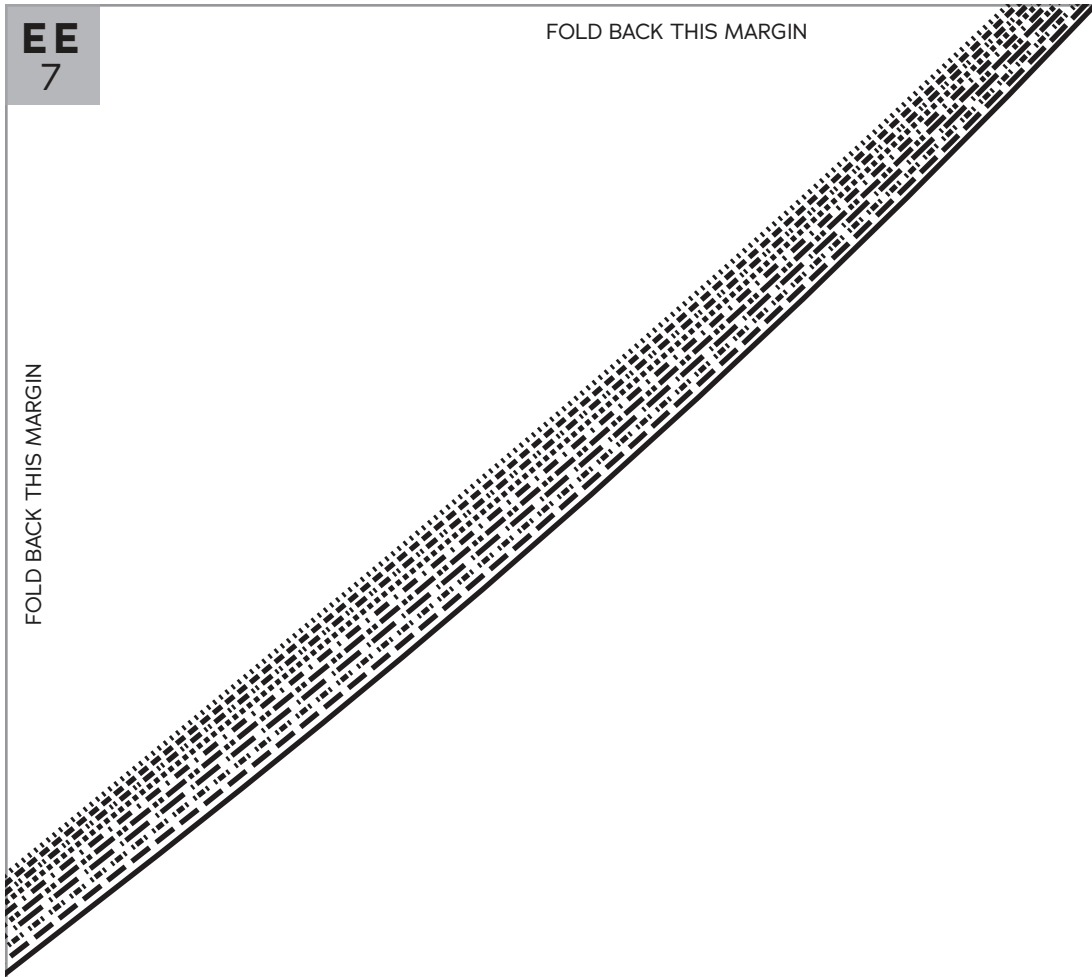

FOLD BACK THIS MARGIN

9



FOLD BACK THIS MARGIN

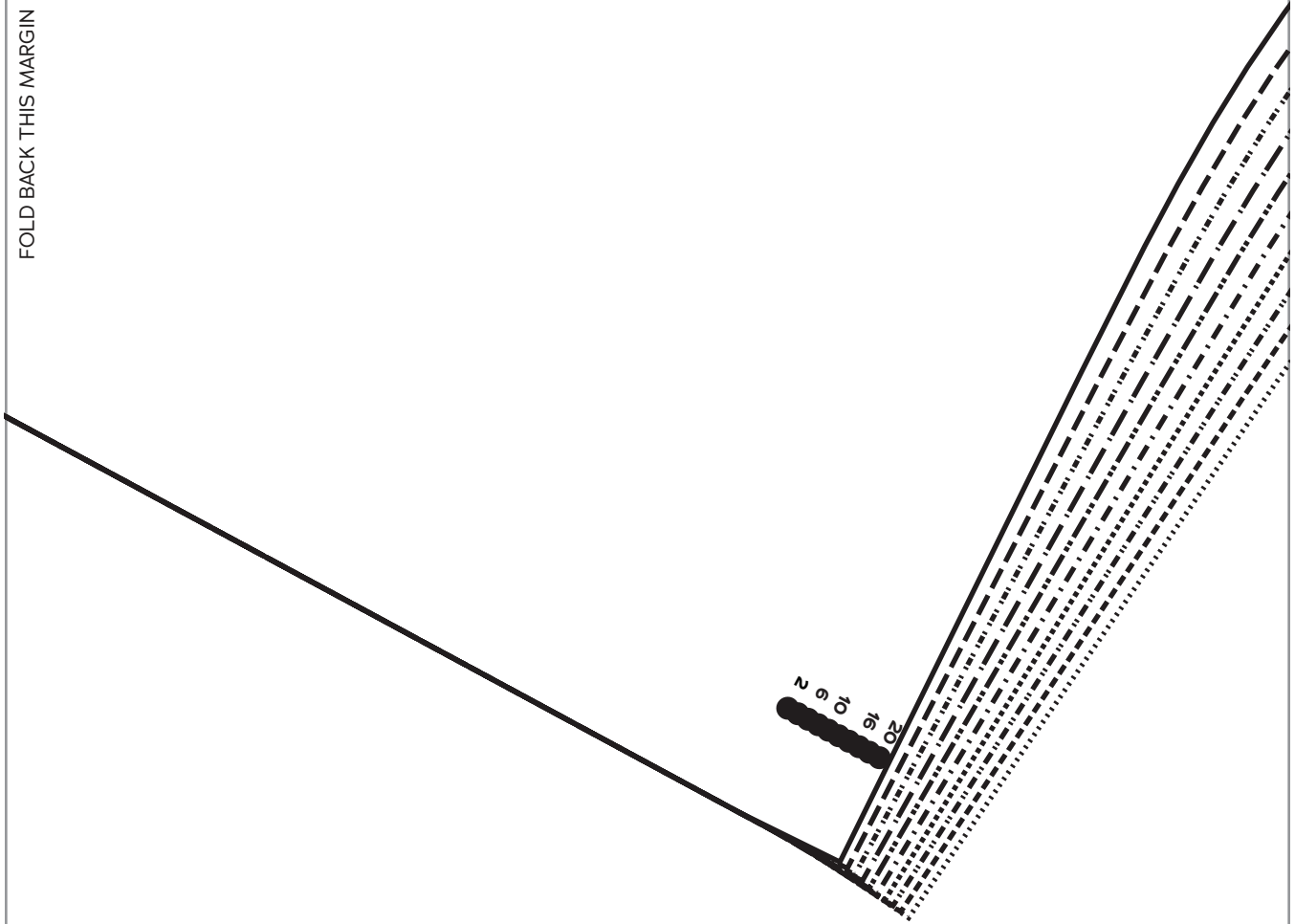

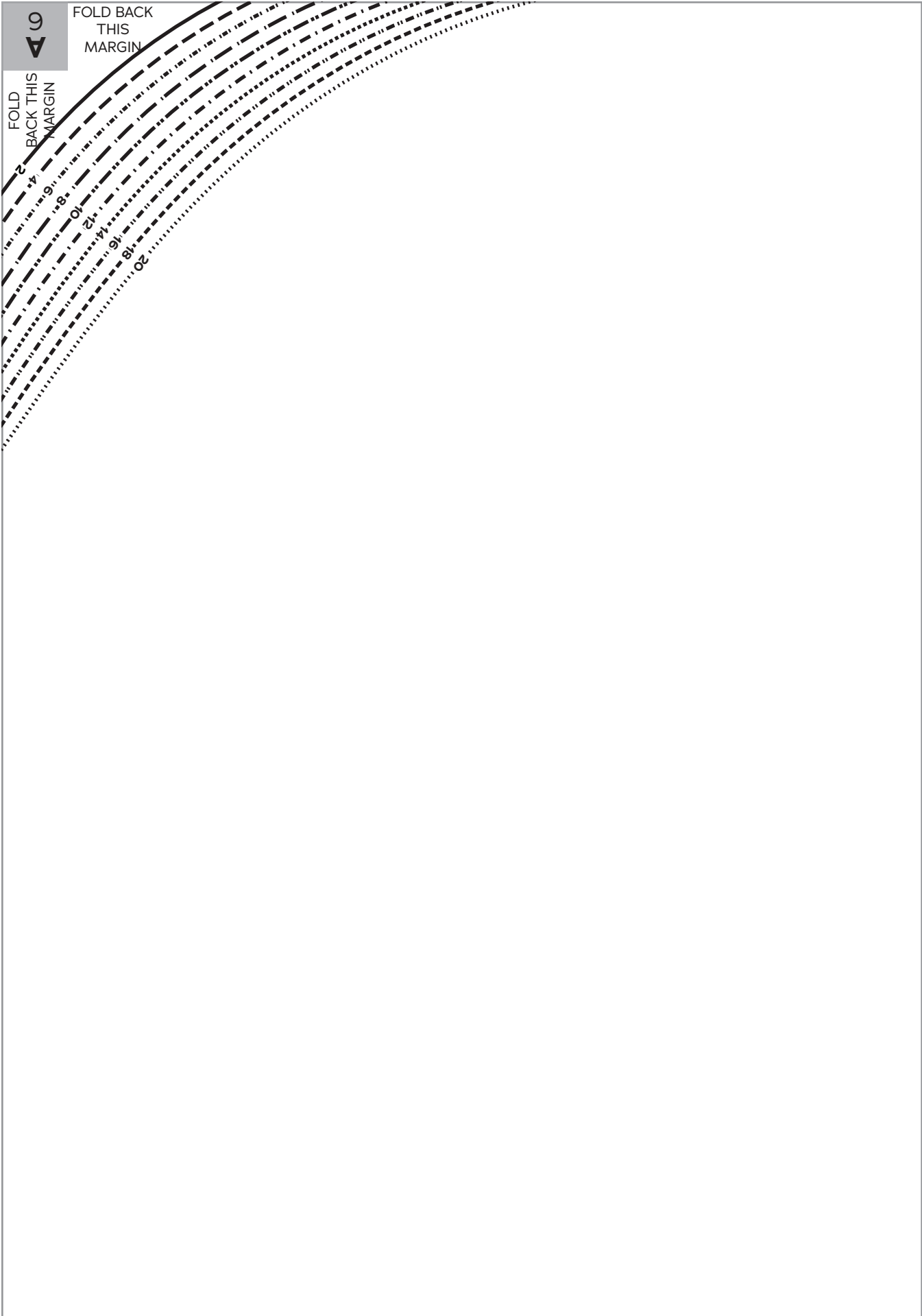

FOLD BACK
THIS MARGIN

FF
7

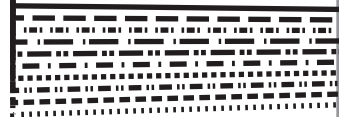

FF
7

FOLD BACK THIS MARGIN

GG
7

FOLD BACK THIS MARGIN



GG
7

FOLD BACK THIS MARGIN

HH
7

FOLD BACK THIS MARGIN

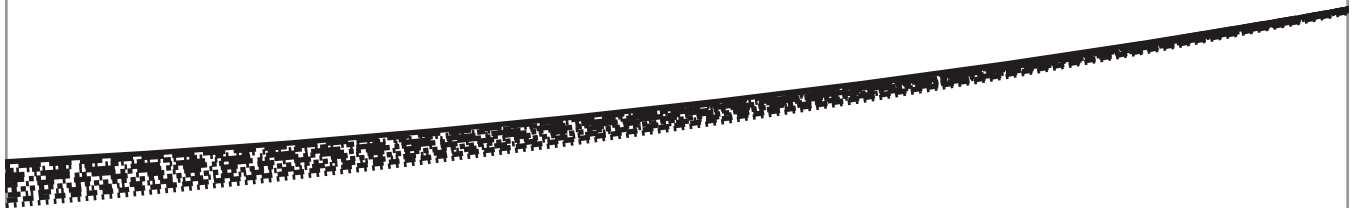

HH
7

FOLD BACK THIS MARGIN

||
7

FOLD BACK THIS MARGIN



II
7

FOLD BACK THIS MARGIN

JJ
7

FOLD BACK THIS MARGIN

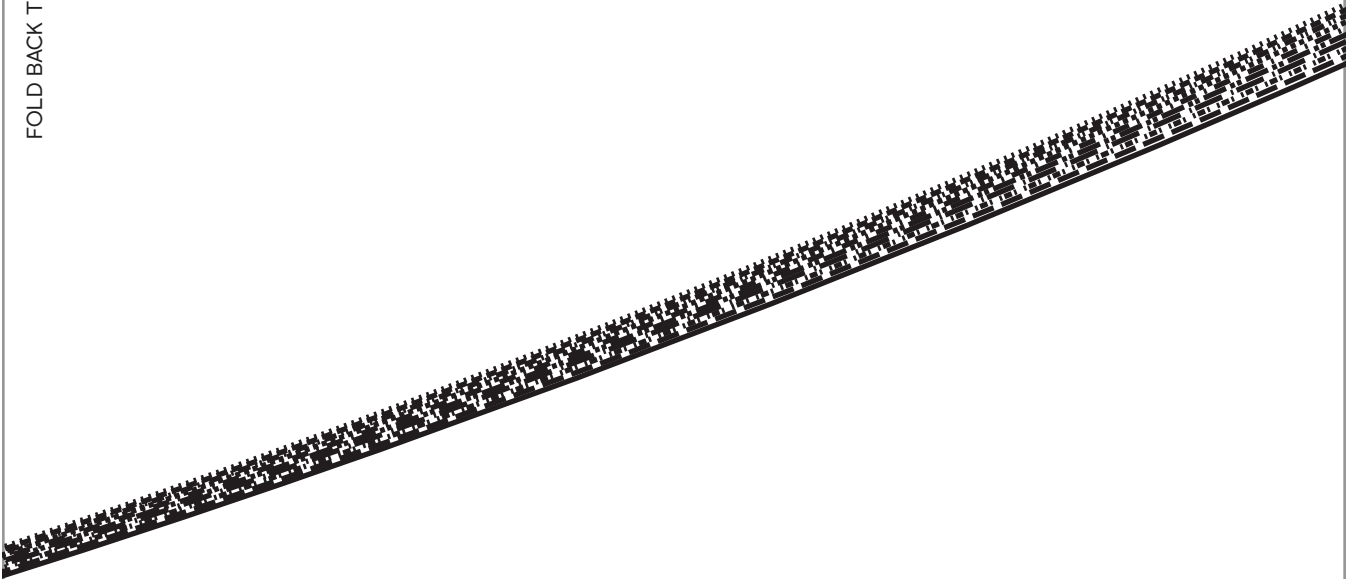

JJ
7

FOLD BACK THIS MARGIN

FOLD BACK THIS MARGIN

