

Society

DRESS



Sizes 2-20
with cup sizes A-H

5/8 inch (in) (1.5 cm) seam allowances are included on all pattern pieces.

SIZES 2-20
PATTERN
SIZE KEY

2	—————
4	- - - - -
6	· · · · ·
8	- - - - -
10	· · · · ·
12	- - - - -
14	· · · · ·
16	- - - - -
18	· · · · ·
20	· · · · ·

SYMBOL KEY

grainline arrow



match point/
placement mark



1 in
test
square

2 cm
test
square

PAGE

1

FOLD BACK THIS MARGIN

FOLD BACK THIS MARGIN

A1

PAGE

2

FOLD BACK THIS MARGIN

A1

FOLD BACK THIS MARGIN

A2

PAGE

3

FOLD BACK THIS MARGIN

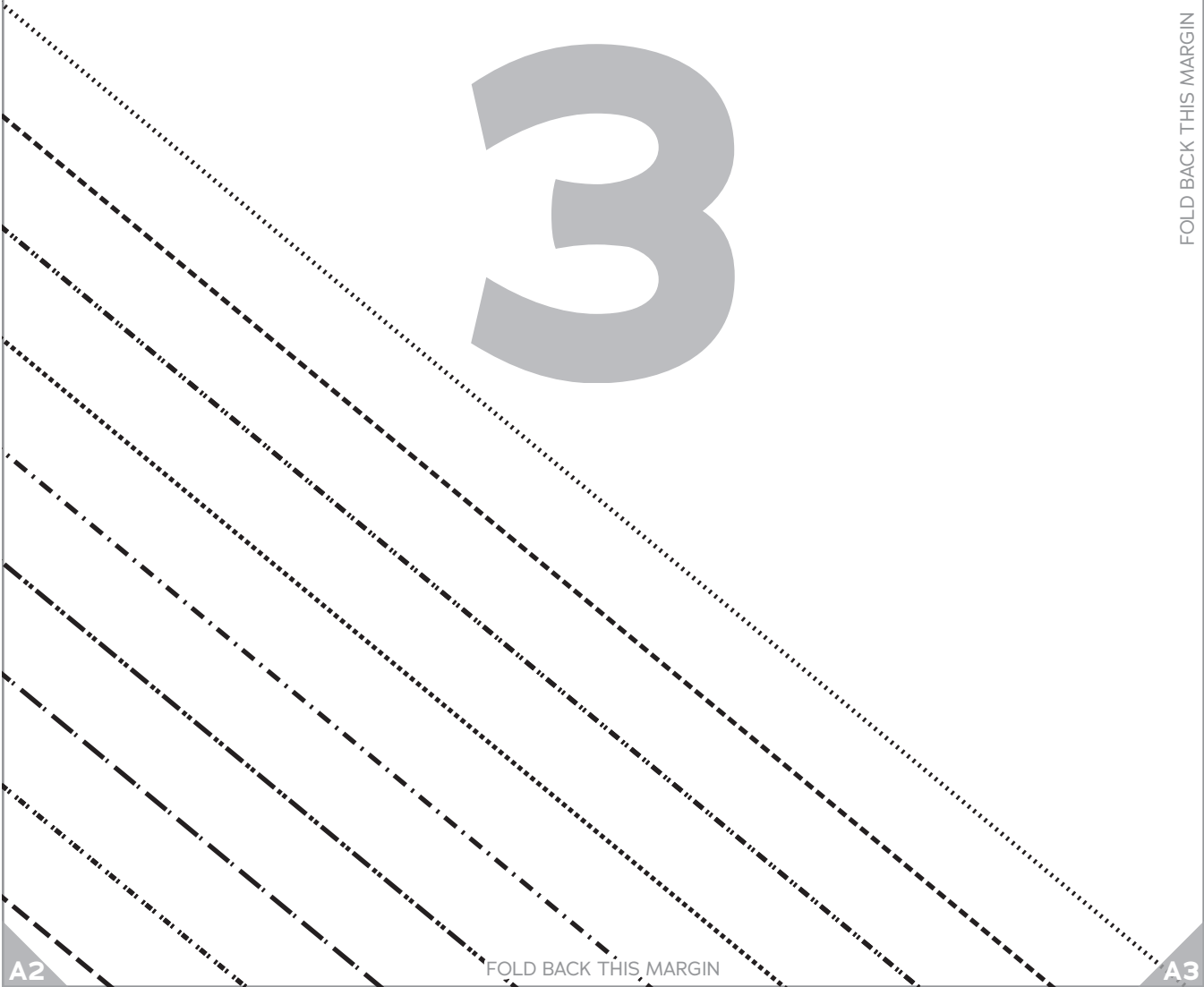

A2

FOLD BACK THIS MARGIN

A3

PAGE

4

FOLD BACK THIS MARGIN

A3

FOLD BACK THIS MARGIN

A4

PAGE

5

FOLD BACK THIS MARGIN

A4

FOLD BACK THIS MARGIN

A5

20

18

16

14

12

10

8

6

4

2

PAGE

6

FOLD BACK THIS MARGIN

A5

FOLD BACK THIS MARGIN

A6

PAGE

7

FOLD BACK THIS MARGIN

A6

FOLD BACK THIS MARGIN

A7

PAGE

8

FOLD BACK THIS MARGIN

A7

FOLD BACK THIS MARGIN

A8

PAGE
9

FOLD BACK THIS MARGIN

A8

FOLD BACK THIS MARGIN

A9

PAGE 10

FOLD BACK THIS MARGIN



A9

FOLD BACK THIS MARGIN

A10

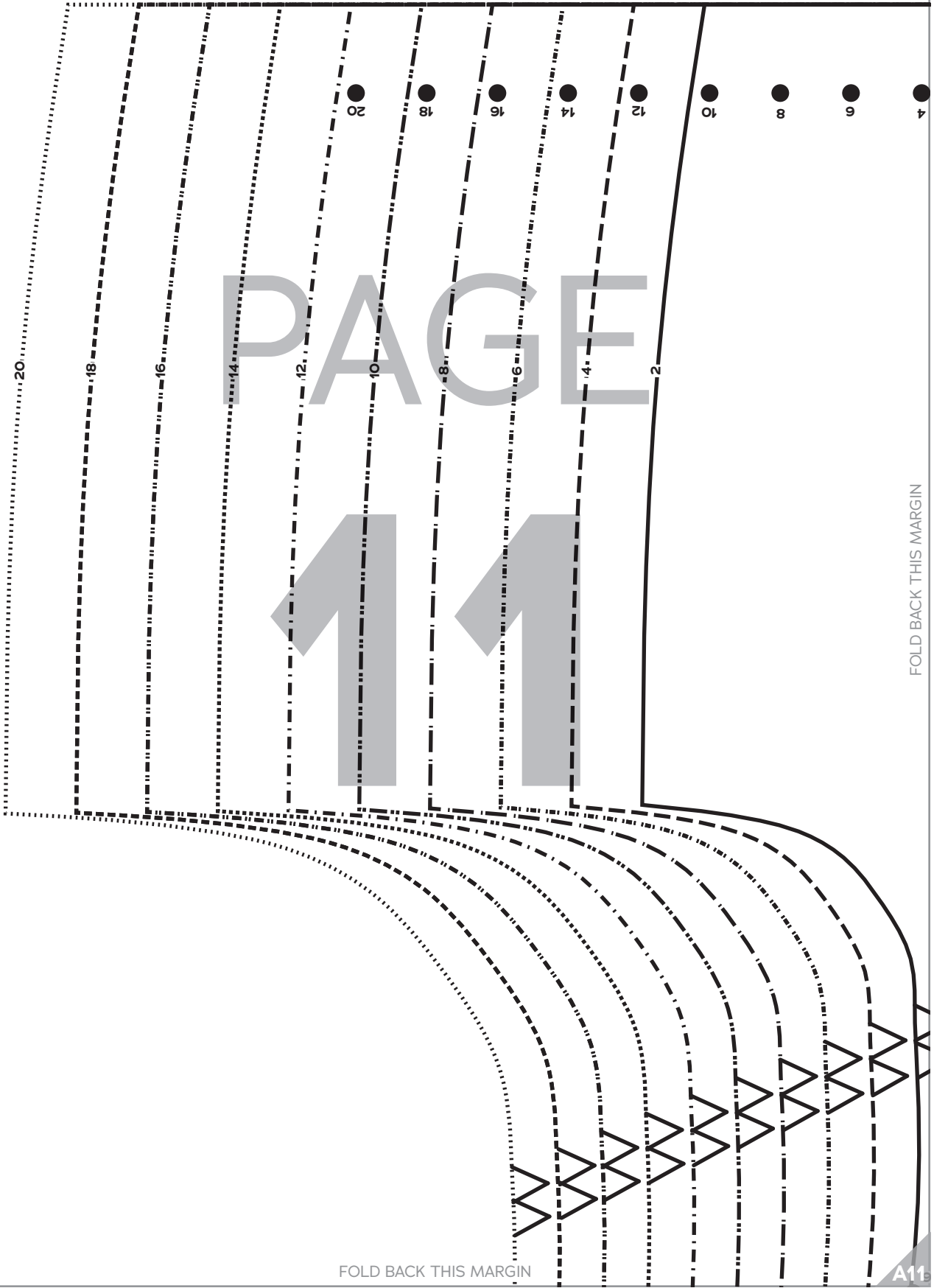

PAGE

11

FOLD BACK THIS MARGIN

FOLD BACK THIS MARGIN

A10

A11

A1

PAGE

13

FOLD BACK THIS MARGIN

FOLD BACK THIS MARGIN

B1

A1

A2

PAGE

14

FOLD BACK THIS MARGIN

B1

FOLD BACK THIS MARGIN

B2

A2

A3

PAGE

15

FOLD BACK THIS MARGIN

B2

FOLD BACK THIS MARGIN

B3

A3

A4

PAGE

16

FOLD BACK THIS MARGIN

FOLD BACK THIS MARGIN

B4

B3

A4

A5

PAGE

17

FOLD BACK THIS MARGIN

FOLD

B4

FOLD BACK THIS MARGIN

B5

A5

A6

Society
of
CHARM
Society
DRESS
SIZES 2-20

11
Knee-Length
Skirt Back
Cut 1 fabric on fold

PAGE

18

FOLD BACK THIS MARGIN

B5

FOLD BACK THIS MARGIN

B6

A6

A7

PAGE 19

FOLD BACK THIS MARGIN

B6

FOLD BACK THIS MARGIN

B7

A7

A8

PAGE
20

FOLD BACK THIS MARGIN

B7

B8

FOLD BACK THIS MARGIN

A8

A9

PAGE

21

Society
of
CHARM

Society
DRESS
SIZES 2-20

15

Cowl

Hood

Cut 4 fabric

GRAINLINE

FOLD BACK THIS MARGIN

B8

FOLD BACK THIS MARGIN

B9

A9

A10

HOOD FRONT

PAGE 22

FOLD BACK THIS MARGIN

B10

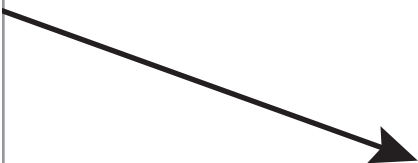

B9

FOLD BACK THIS MARGIN



B10

A10

A11

PAGE 23

FOLD BACK THIS MARGIN

FOLD BACK THIS MARGIN

B10

B11

PAGE

24

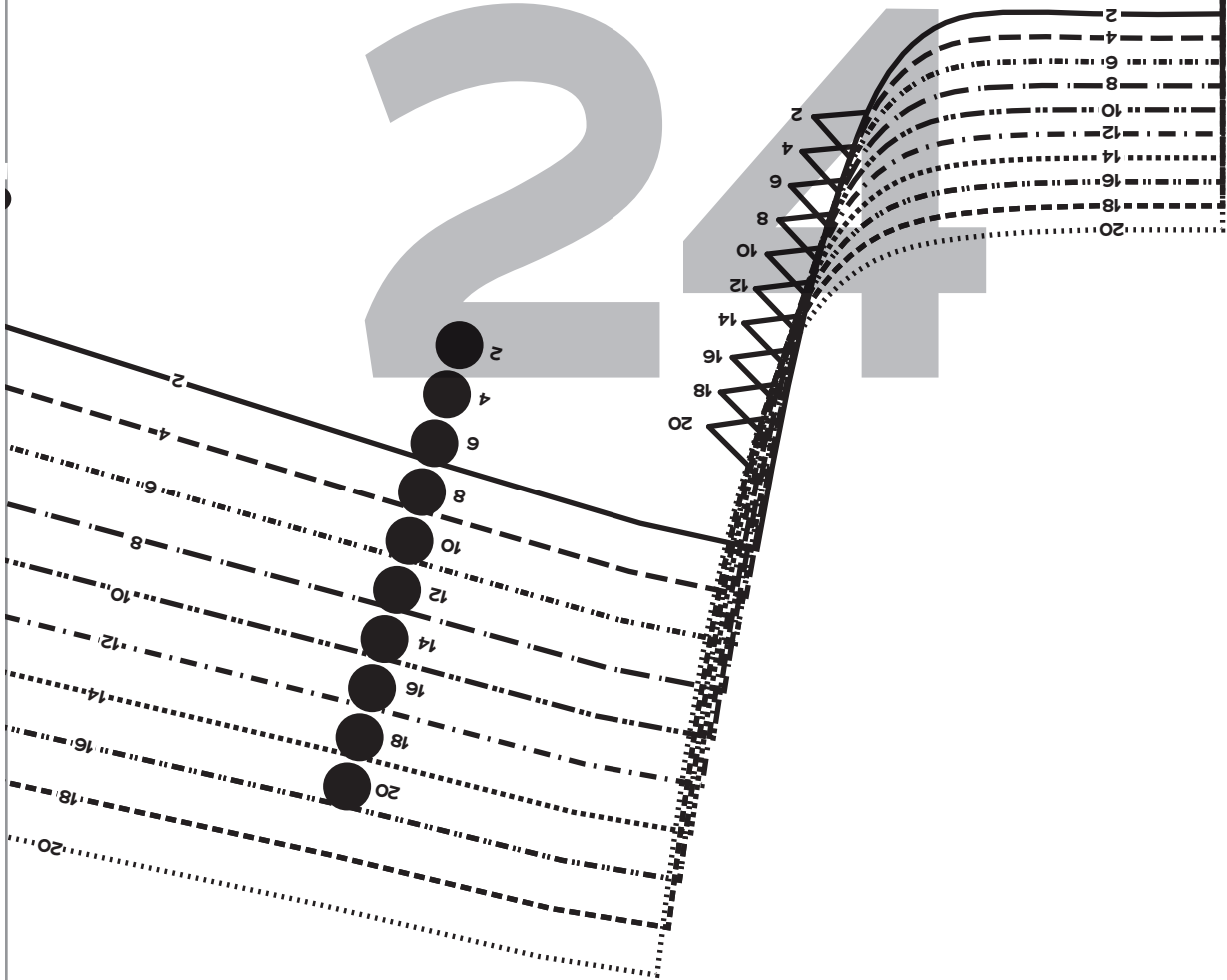

PAGE

25

FOLD BACK THIS MARGIN

FOLD BACK THIS MARGIN



B1

B2

PAGE

26

FOLD BACK THIS MARGIN

C1

FOLD BACK THIS MARGIN

C2

B2

B3

10
Society
 of CHARM
DRESS
 SIZES 2-20
PR **GE**
 Knee-Length
 Skirt Front
 Cut 1 fabric on fold

27

FOLD BACK THIS MARGIN

FOLD

C2

FOLD BACK THIS MARGIN

C3

B3

B4

PAGE 28

FOLD BACK THIS MARGIN

C3

FOLD BACK THIS MARGIN

C4

B4

B5

PAGE
29

FOLD BACK THIS MARGIN

C4

FOLD BACK THIS MARGIN

C5

B5

B6

PAGE

30

FOLD BACK THIS MARGIN

C5

FOLD BACK THIS MARGIN

C6

B6

B7

PAGE

31

FOLD BACK THIS MARGIN

C6

FOLD BACK THIS MARGIN

C7

B7

B8

PAGE
32

FOLD BACK THIS MARGIN

C7

FOLD BACK THIS MARGIN

C8

B8

B9

PAGE

33

BACK

FOLD BACK THIS MARGIN

2
4
6
8
10
12
14
16
18
20

C8

FOLD BACK THIS MARGIN

C9

B9

B10



COOL HOOD



PAGE

34

FOLD BACK THIS MARGIN

C9

FOLD BACK THIS MARGIN

C10

B10

B11

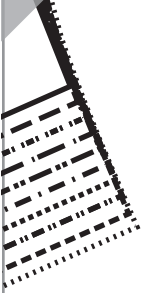

FOLD BACK THIS MARGIN

FOLD BACK THIS MARGIN

C10

C11

Society
of CHARM
Society
DRESS
SIZES 2-20

6
Bishop
Sleeve Cuff
Cut 2 fabric

FOLD LINE

GRAINLINE

2 4 6 8 10 12 14 16 18 20

2 4 6 8 10 12 14 16 18 20



PAGE

37

FOLD BACK THIS MARGIN



FOLD BACK THIS MARGIN



C1

C2

PAGE

38

D1

D2

FOLD BACK THIS MARGIN

FOLD BACK THIS MARGIN

20"

18"

16"

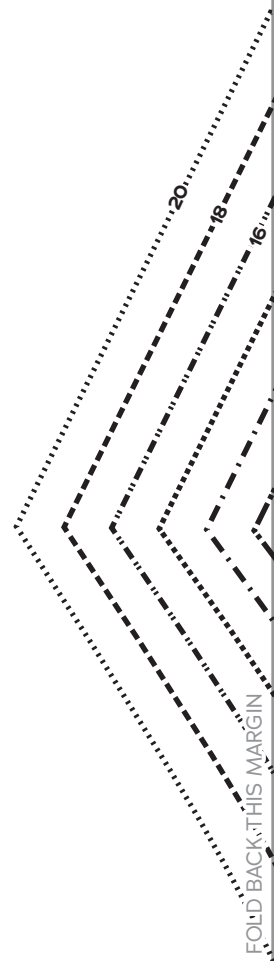

C2

C3

PAGE

39

FOLD BACK THIS MARGIN

D2

D3

FOLD BACK THIS MARGIN

C3

C4

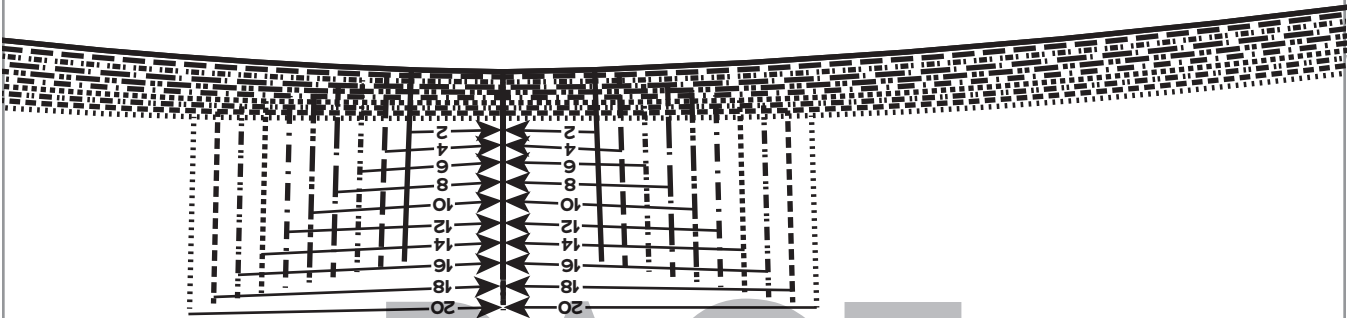

PAGE

40

Short Pleated
Sleeve
Cut 2 fabric

7
SIZES 2-20
DRESS
Society
Society
of CHARM

GRAINLINE

FOLD BACK THIS MARGIN

D3

FOLD BACK THIS MARGIN

D4

C4

C5

PAGE
441

FOLD BACK THIS MARGIN

- 2 ●
- 4 ●
- 6 ●
- 8 ●
- 10 ●
- 12 ●
- 14 ●
- 16 ●

FOLD BACK THIS MARGIN

D4

D5

C5

C6

PAGE

42

FOLD BACK THIS MARGIN

D5

FOLD BACK THIS MARGIN

D6

C6

C7

PAGE

43

FOLD BACK THIS MARGIN

2

4

FOLD BACK THIS MARGIN

D6

D7

C7

C8

PAGE

44

FOLD BACK THIS MARGIN



D7

FOLD BACK THIS MARGIN

D8

C8

C9

PAGE

FOLD

45

Society
of
CHARM

Society

DRESS
SIZES 2-20

12

Floor-Length
Skirt Front

Cut 1 fabric on fold

FOLD BACK THIS MARGIN

D8

FOLD BACK THIS MARGIN

GODET CUTTING LINE

D9

C9

C10

PAGE

46

FOLD BACK THIS MARGIN

D9

FOLD BACK THIS MARGIN

D10

C10

C11



PAGE

47

FOLD BACK THIS MARGIN

D10

FOLD BACK THIS MARGIN

D11

C11

PAGE

48

D11

FOLD BACK THIS MARGIN

PAGE 49

GRAINLINE

FOLD BACK THIS MARGIN

FOLD BACK THIS MARGIN

D1

D2

PAGE

50

FOLD BACK THIS MARGIN

E1

FOLD BACK THIS MARGIN

E2

D2

D3

PAGE

51

FOLD BACK THIS MARGIN

E2

FOLD BACK THIS MARGIN

E3

D3

D4



TO SHOULDER SEAM

PAGE

52

FOLD BACK THIS MARGIN

E3

FOLD BACK THIS MARGIN

E4

D4

D5

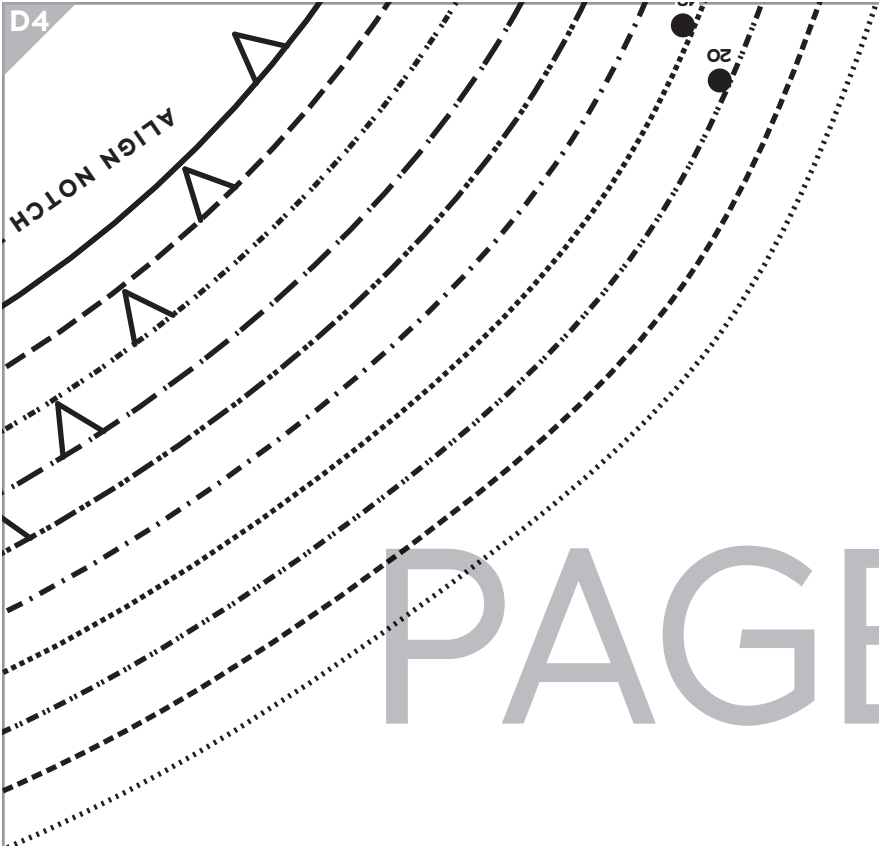

PAGE

53

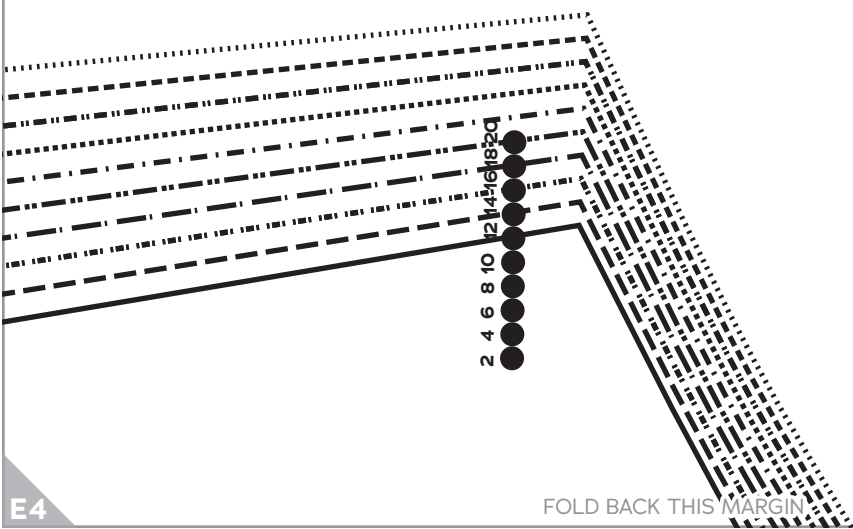
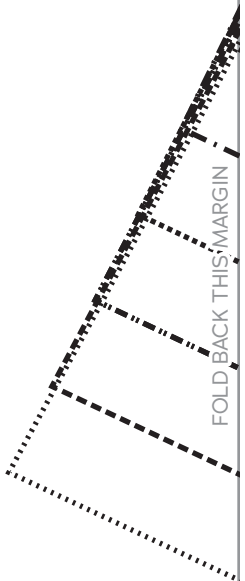

E4

E5

D5

D6

PAGE

54

FOLD BACK THIS MARGIN

E5

FOLD BACK THIS MARGIN

E6

D6

D7

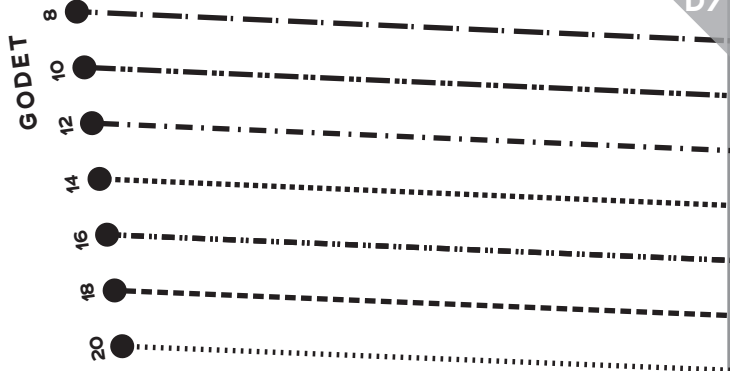

PAGE

55

SIDE SEAM
GODET



6

8

10

12

14

16

18

20

FOLD BACK THIS MARGIN

FOLD BACK THIS MARGIN

E6

E7

D7

D8

PAGE

56

FOLD BACK THIS MARGIN

E7

FOLD BACK THIS MARGIN

E8

D8

D9

PAGE

57

FOLD BACK THIS MARGIN

E8

FOLD BACK THIS MARGIN

E9

D9

D10

PAGE

58

FOLD BACK THIS MARGIN

E9

FOLD BACK THIS MARGIN

E10

D10

D11

PAGE

59

FOLD BACK THIS MARGIN

E10

FOLD BACK THIS MARGIN

E11

D11

PAGE

60

2 4 6 8 10 12 14 16 18 20

E11

FOLD BACK THIS MARGIN

E1

Floor-Length
Skirt Godet
Cut 6 fabric

14

SIZES 2-20

DRESS

Society

of CHARM

PAGE

61

FOLD BACK THIS MARGIN

FOLD BACK THIS MARGIN

F1

E1

E2

PAGE

62

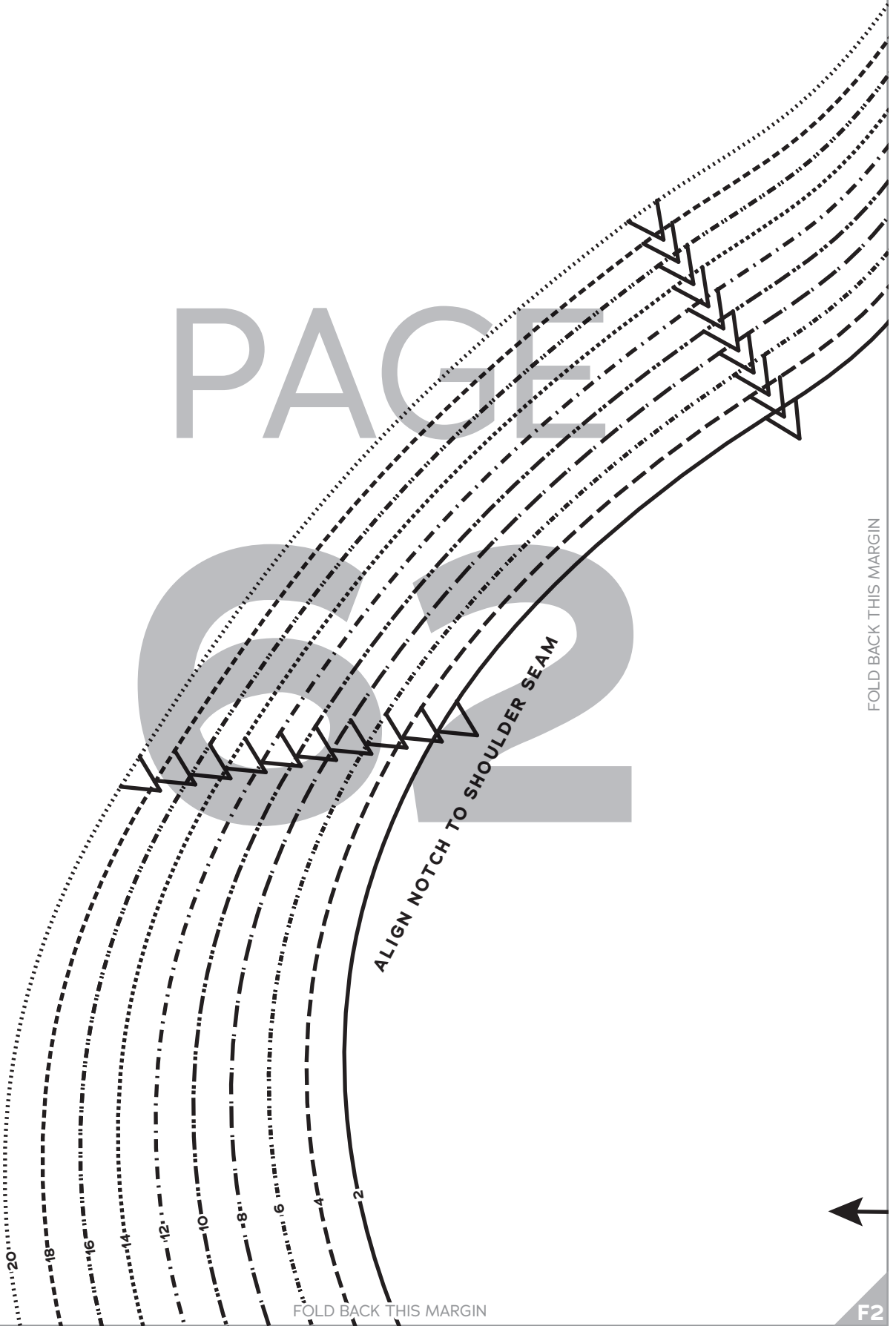

ALIGN NOTCH TO SHOULDER SEAM

FOLD BACK THIS MARGIN

F1

FOLD BACK THIS MARGIN

F2

E2

E3

6

4

2

PAGE

63

FOLD BACK THIS MARGIN

F2

FOLD BACK THIS MARGIN

F3

E3

E4

PAGE

64

FOLD BACK THIS MARGIN

Society
of CHARM
Society

DRESS
SIZES 2-20

5

**Bishop
Sleeve**
Cut 2 fabric

GRAINLINE

F3

FOLD BACK THIS MARGIN

F4

E4

E5

PAGE 65

FOLD BACK THIS MARGIN

GATHER BETWEEN CIRCLES



F4

FOLD BACK THIS MARGIN

F5

E5

E6

PAGE

66

FOLD BACK THIS MARGIN

F5

FOLD BACK THIS MARGIN

F6

E6

E7

PAGE

67

FOLD BACK THIS MARGIN

F6

FOLD BACK THIS MARGIN

F7

E7

E8

PAGE

68

FOLD BACK THIS MARGIN

F7

FOLD BACK THIS MARGIN

F8

E8

E9

8

10

12

14

16

18

20

PAGE

69

FOLD BACK THIS MARGIN

FOLD

F8

FOLD BACK THIS MARGIN

F9

E9

E10

PAGE

70

FOLD BACK THIS MARGIN

F9

FOLD BACK THIS MARGIN

F10

E10

E11

PAGE

71

FOLD BACK THIS MARGIN

F10

FOLD BACK THIS MARGIN

F11

E11

PAGE

72

F11

FOLD BACK THIS MARGIN

PAGE 73

FOLD BACK THIS MARGIN

FOLD BACK THIS MARGIN

F1

F2

PAGE

74

FOLD BACK THIS MARGIN

G1

FOLD BACK THIS MARGIN

G2

F2

F3

PAGE

75

FOLD BACK THIS MARGIN

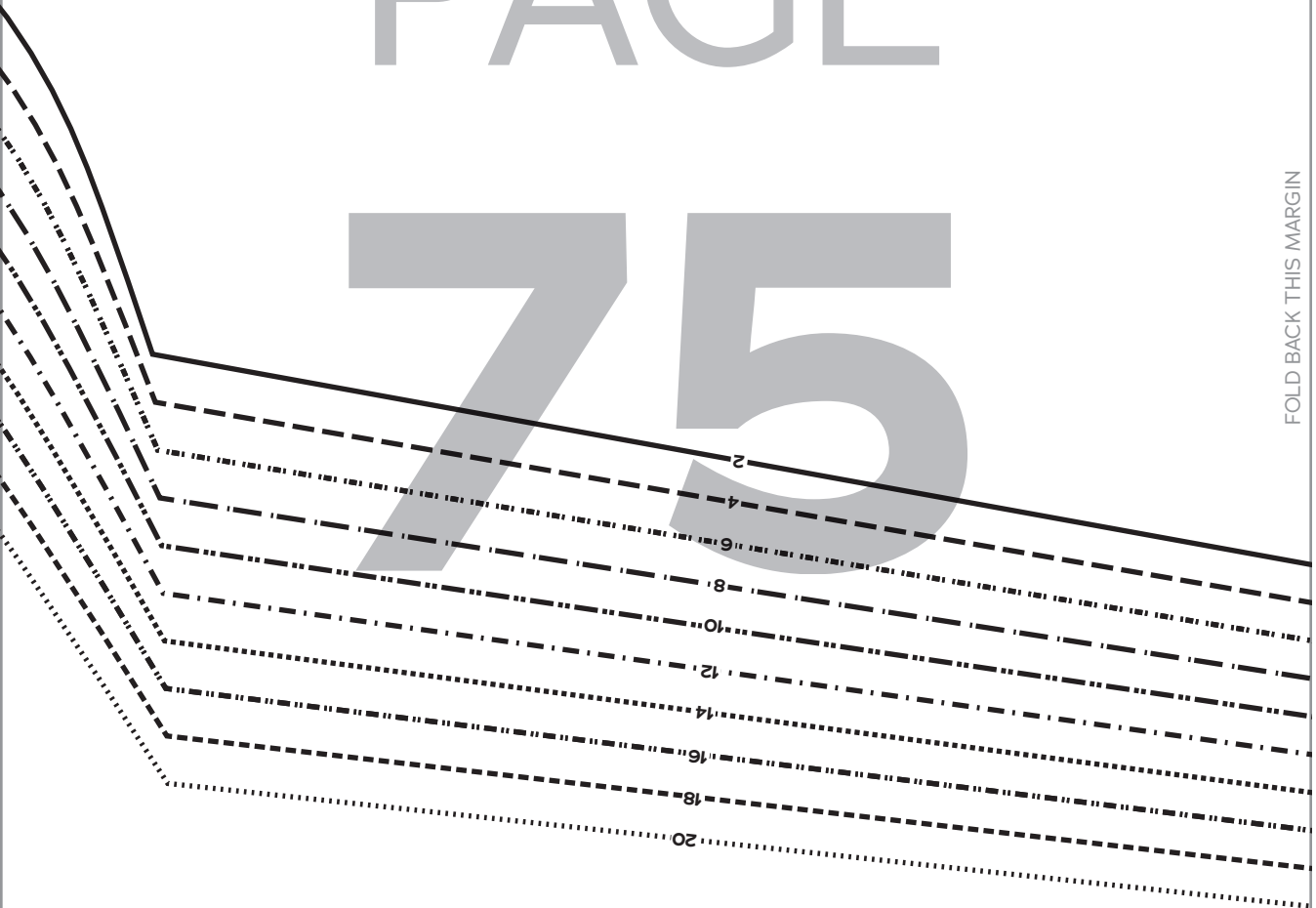

G2

FOLD BACK THIS MARGIN

G3

F3

F4

PAGE 76

FOLD BACK THIS MARGIN

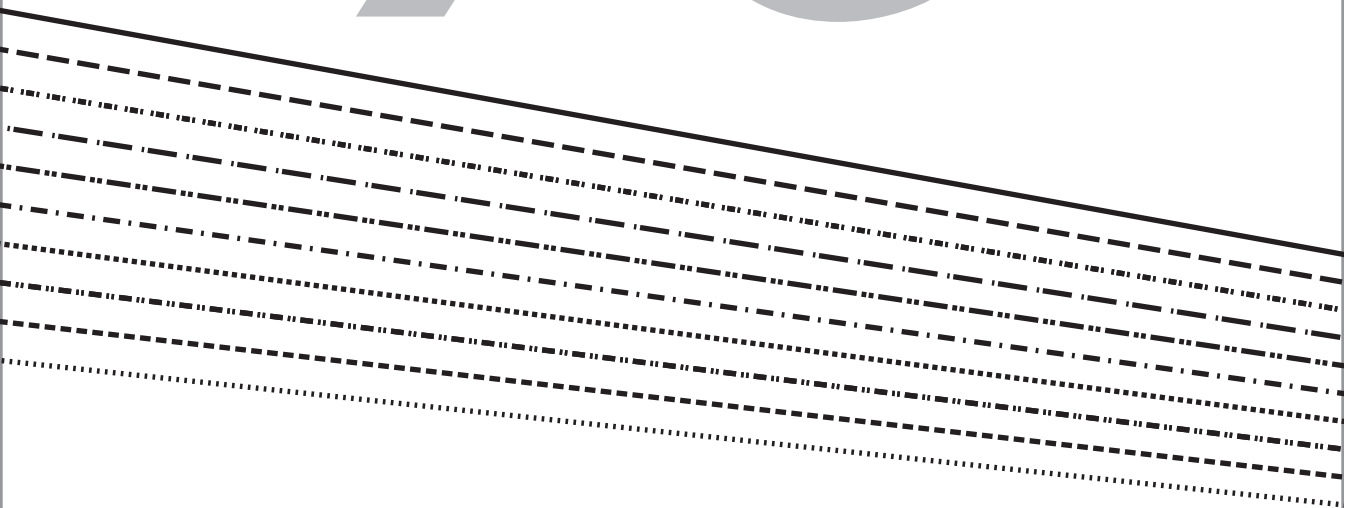

G3

FOLD BACK THIS MARGIN

G4

F4

F5

PAGE
77

FOLD BACK THIS MARGIN

20 18 16 14 12 10 8 6 4 2

G4

FOLD BACK THIS MARGIN

G5

F5

F6

G5

G6

20

18

16

14

12

10

8

6

4

2

PAGE

78

FOLD BACK THIS MARGIN

FOLD BACK THIS MARGIN

F6

F7

PAGE

79

FOLD BACK THIS MARGIN

G6

FOLD BACK THIS MARGIN

G7

F7

F8

PAGE

80

FOLD BACK THIS MARGIN

G7

FOLD BACK THIS MARGIN

G8

F8

F9

13
Floor-Length
Skirt Back
Cut 1 fabric on fold

Society
of
CHARM
DRESS
SIZES 2-20

PAGE

81

GODET CUTTING LINE

FOLD BACK THIS MARGIN

G8

FOLD BACK THIS MARGIN

G9

F9

F10

PAGE

82

FOLD BACK THIS MARGIN

G9

FOLD BACK THIS MARGIN

G10

F10

F11

PAGE

83

FOLD BACK THIS MARGIN

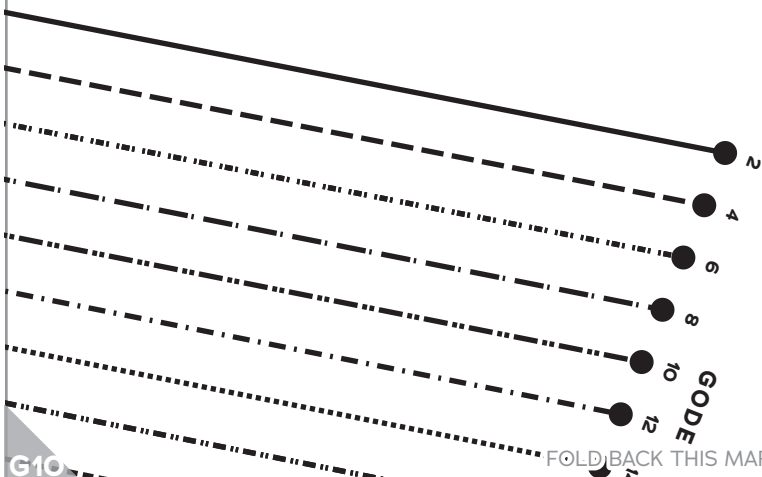

FOLD BACK THIS MARGIN

G10

G11

PAGE

84

PAGE

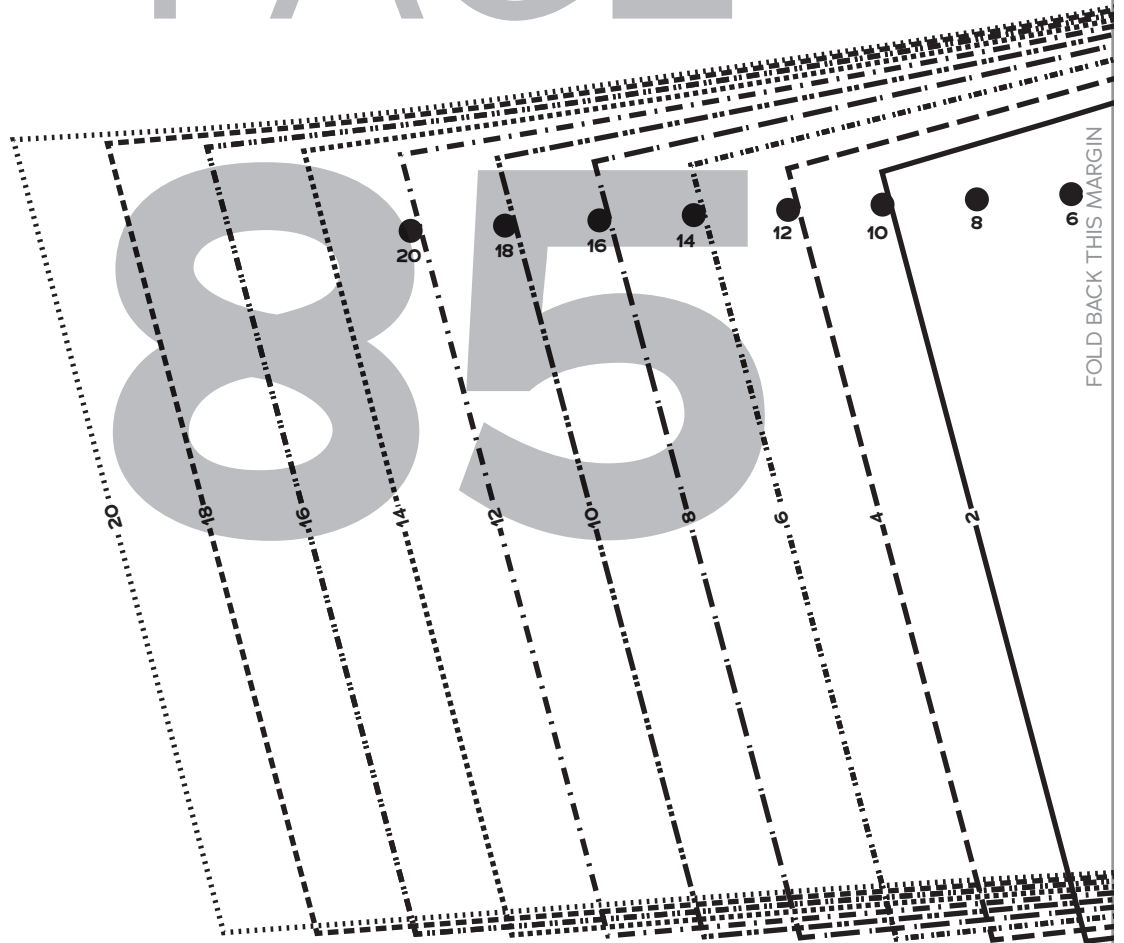

FOLD BACK THIS MARGIN

G1

G2

PAGE

●
4

●
2

Society
of CHARM

Society

DRESS

SIZES 2-20

3

Midriff
Front

Cut 1 fabric on fold,
1 power mesh on fold



FOLD BACK THIS MARGIN

H1

FOLD BACK THIS MARGIN

H2

PAGE



FOLD

2 4 6 8 10 12 14 16 18 20

2

4

FOLD BACK THIS MARGIN

Society of CHARM
Society
DRESS
 SIZES 2-20

4
 Midriff
 Back

Cut 1 fabric on fold

G3

G4

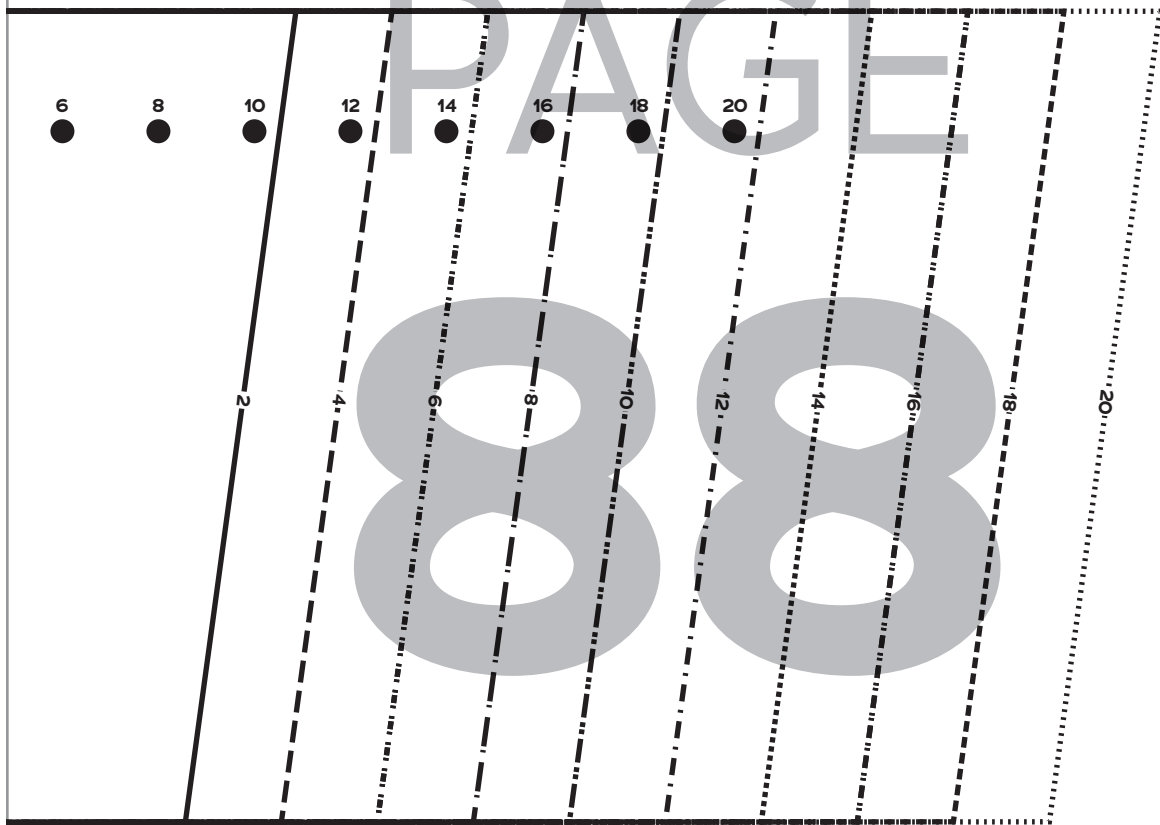

FOLD BACK THIS MARGIN

H3

FOLD BACK THIS MARGIN

H4

PAGE

89

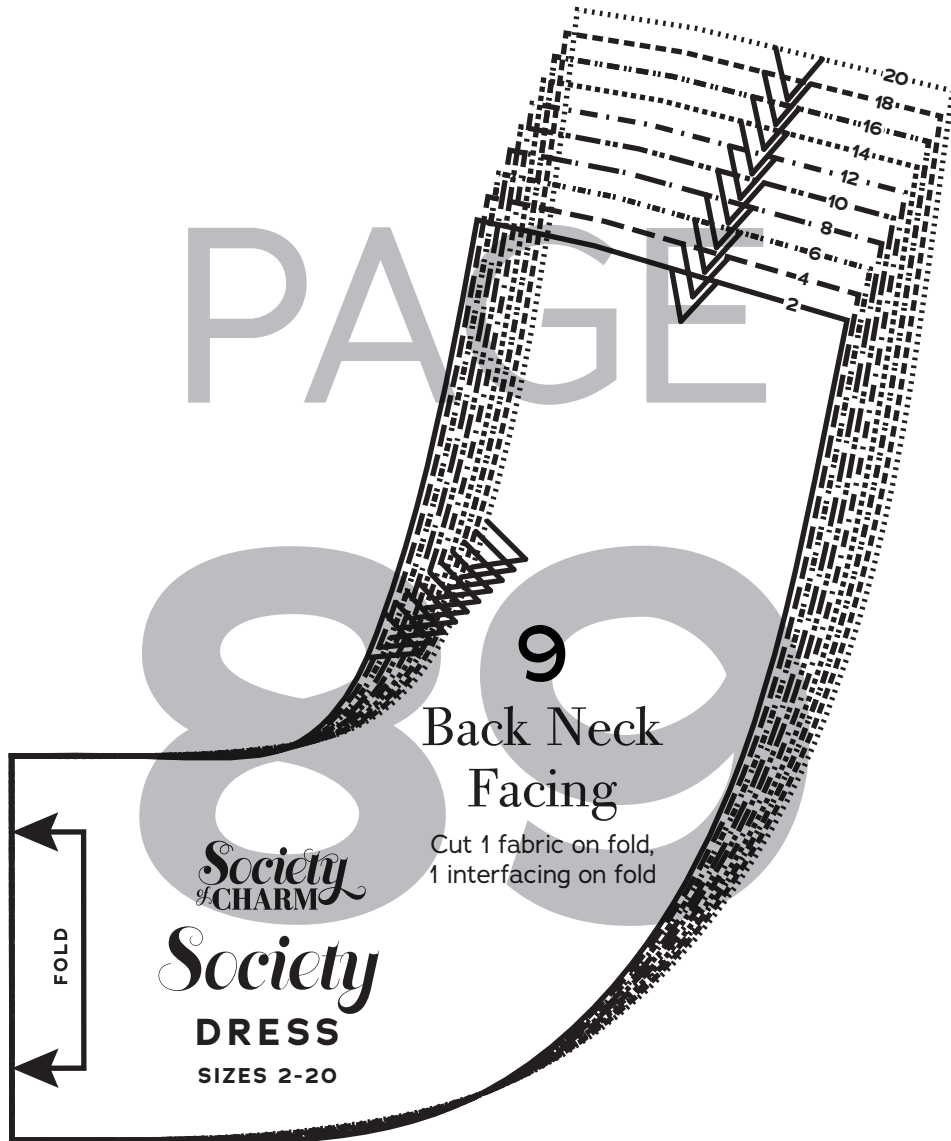

FOLD BACK THIS MARGIN

G5

G6

PAGE

90

FOLD BACK THIS MARGIN

FOLD BACK THIS MARGIN

H5

H6

G6

G7

PAGE

91

FOLD BACK THIS MARGIN

H6

FOLD BACK THIS MARGIN

H7

G7

G8

PAGE

92

FOLD BACK THIS MARGIN

2

4

6

8

10

12

14

16

18

20

H7

FOLD BACK THIS MARGIN

H8

G8

G9

PAGE

93

FOLD BACK THIS MARGIN

H8

FOLD BACK THIS MARGIN

H9

PAGE

94

FOLD BACK THIS MARGIN



G10

G11

16
18
20

PAGE

95

SIDE SEAM
GODET

FOLD BACK THIS MARGIN

FOLD BACK THIS MARGIN

H10

H11

PAGE

96

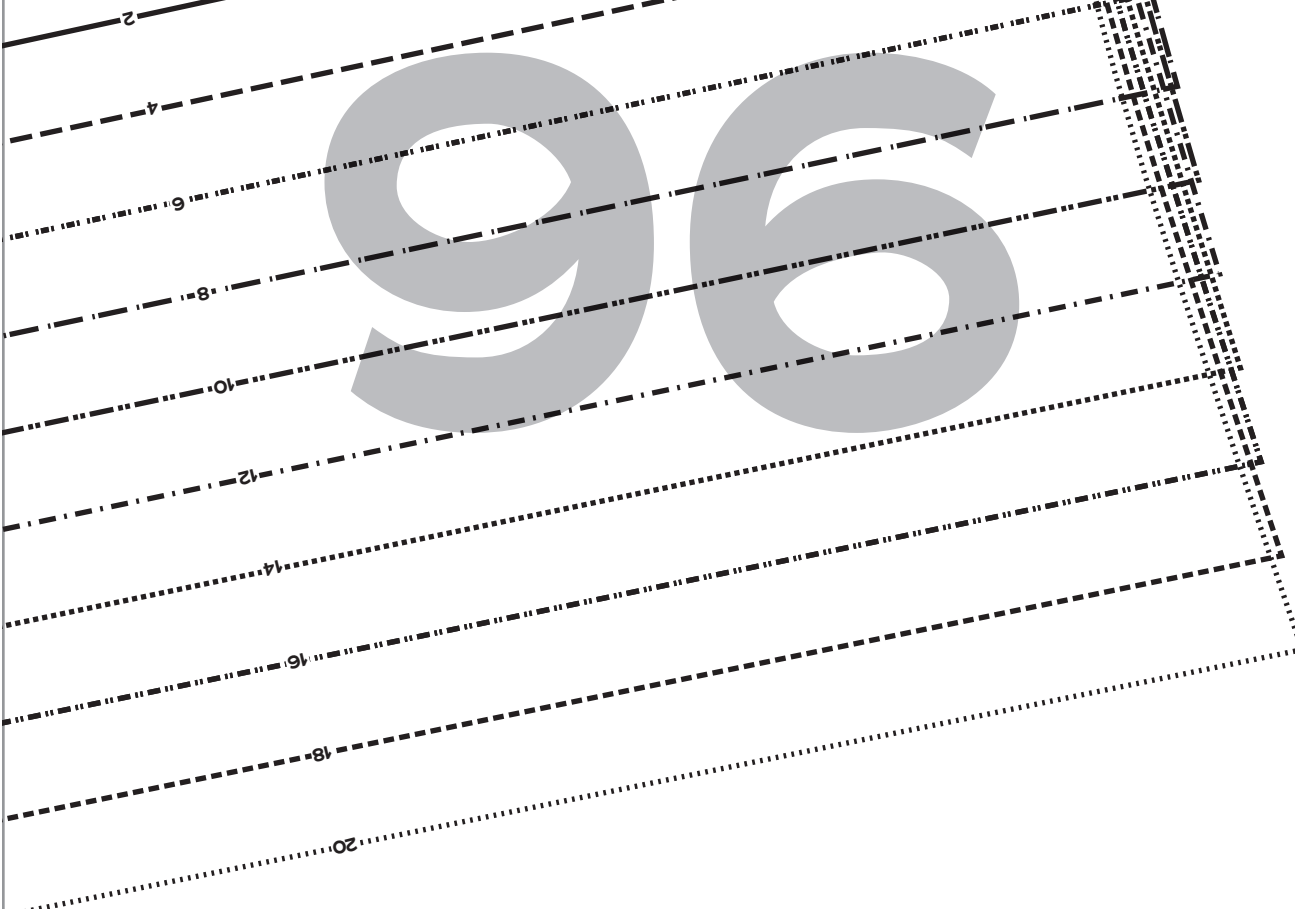

PAGE

GATHER BETWEEN CIRCLES

97

FOLD BACK THIS MARGIN

2
10
20

Bodice Front,
A Cup
Cut 2 fabric



SIZES 2-20
DRESS
Society
Society of CHARM

GRAINLINE

FOLD BACK THIS MARGIN

H1

H2

● 2 ● 4 ● 6 ● 8 ● 10 ● 12 ● 14 ● 16 ● 18 ● 20

PAGE

98

FOLD BACK THIS MARGIN

FOLD BACK THIS MARGIN

I1

I2

PAGE

99

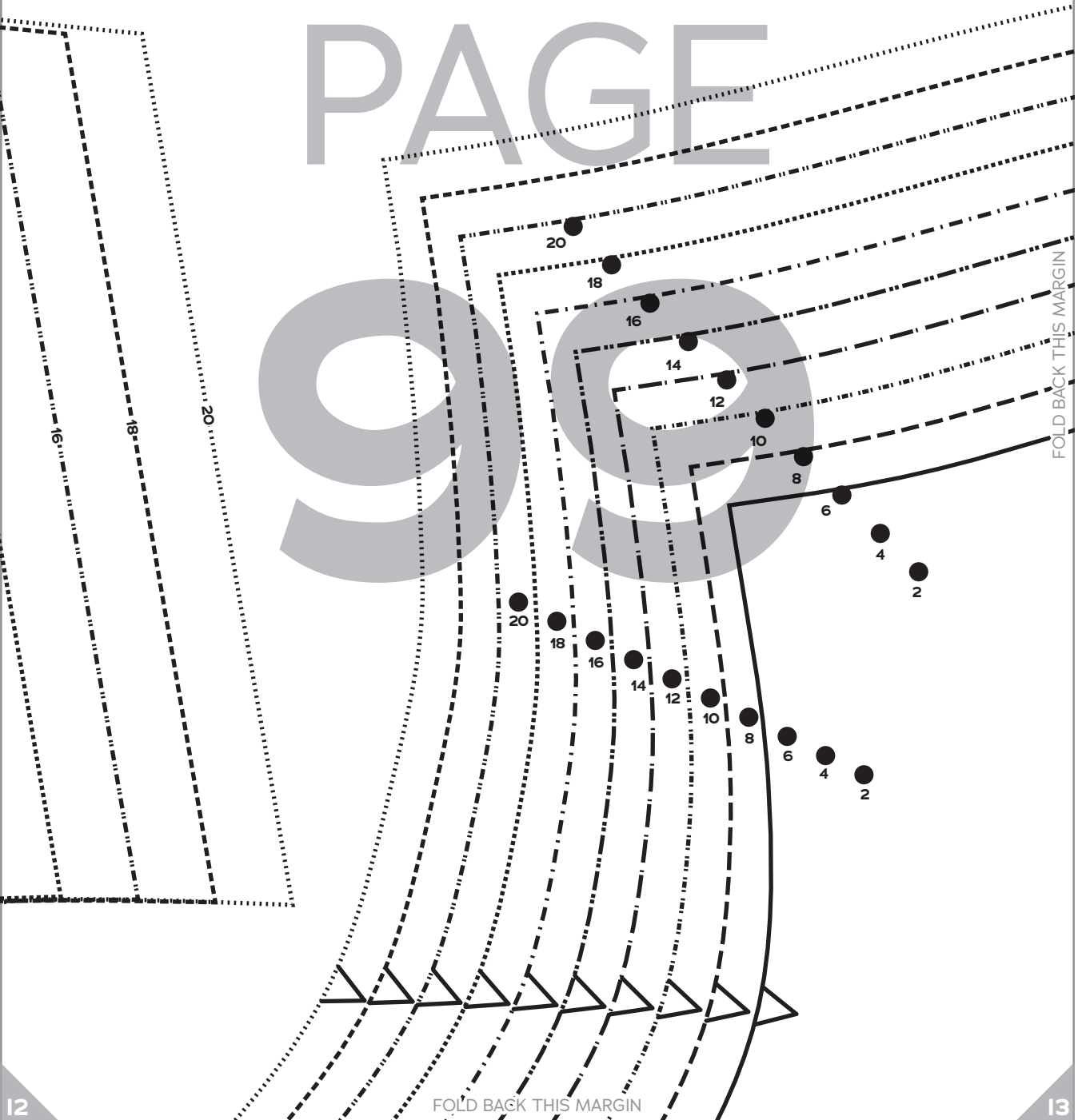

H3

H4

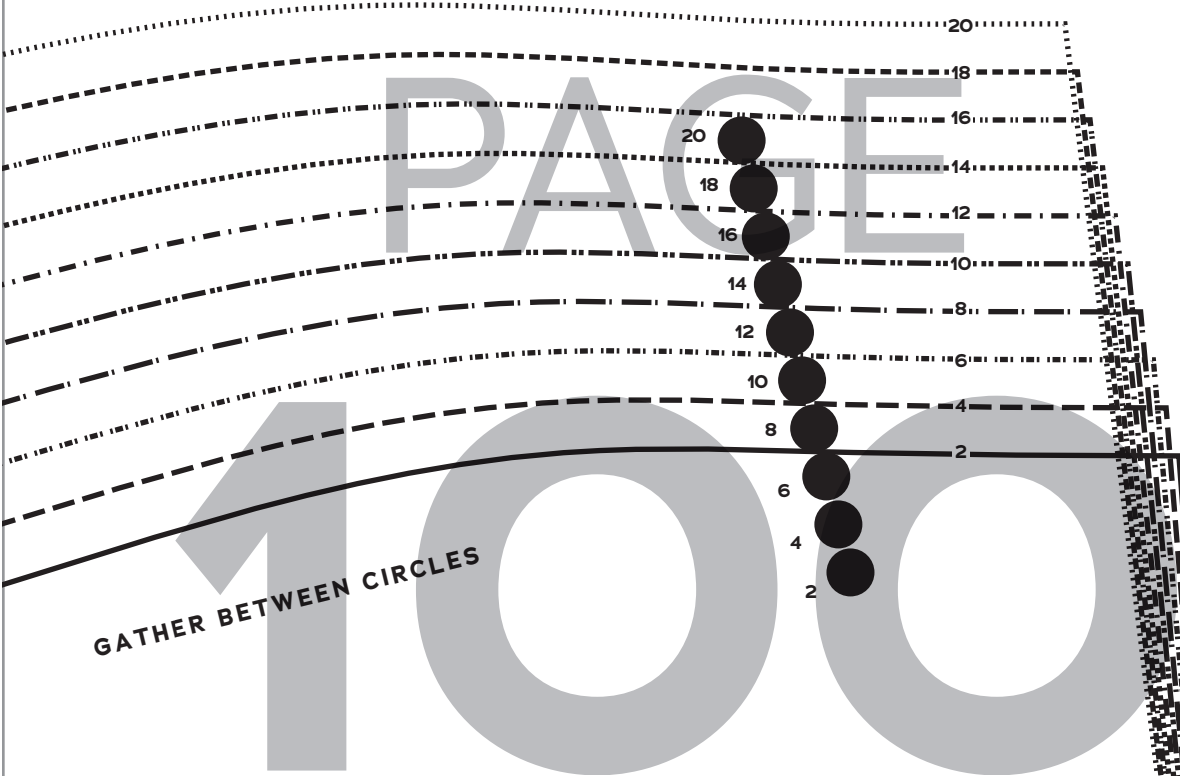

GATHER BETWEEN CIRCLES

FOLD BACK THIS MARGIN

I3

FOLD BACK THIS MARGIN

I4

H4

H5

PAGE

ATHER BETWEEN CIRCLES

101

FOLD BACK THIS MARGIN

2
10
20

Bodice Front,
D/DD Cup
Cut 2 fabric



SIZES 2-20

DRESS
Society
Society
of CHARM

GRAINLINE

I4

FOLD BACK THIS MARGIN

I5

H5

H6

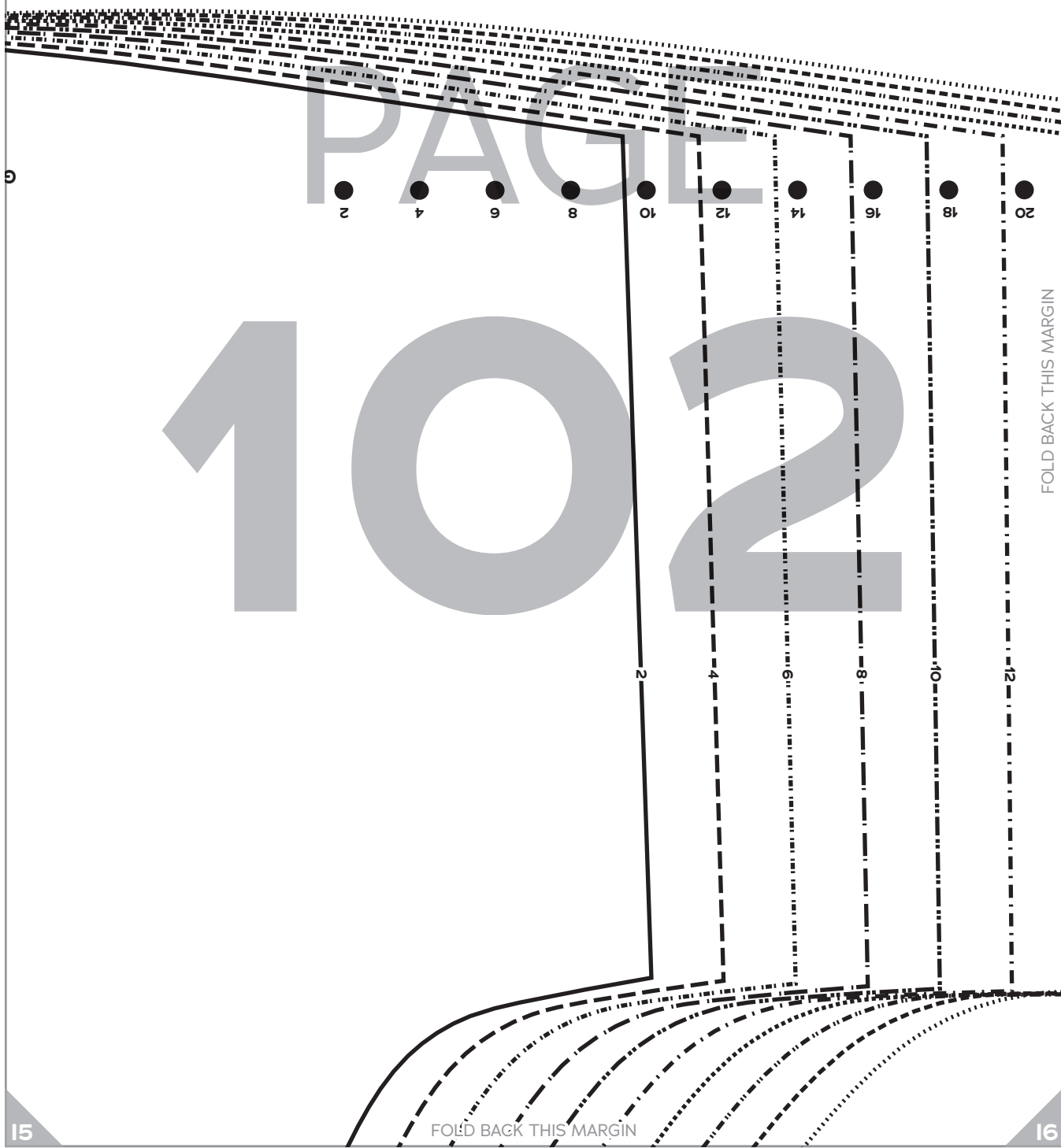

G

2 4 6 8 10 12 14 16 18 20

102

PAGLE

FOLD BACK THIS MARGIN

2 4 6 8 10 12

FOLD BACK THIS MARGIN

I5

I6

PAGE

103

FOLD BACK THIS MARGIN

FOLD BACK THIS MARGIN

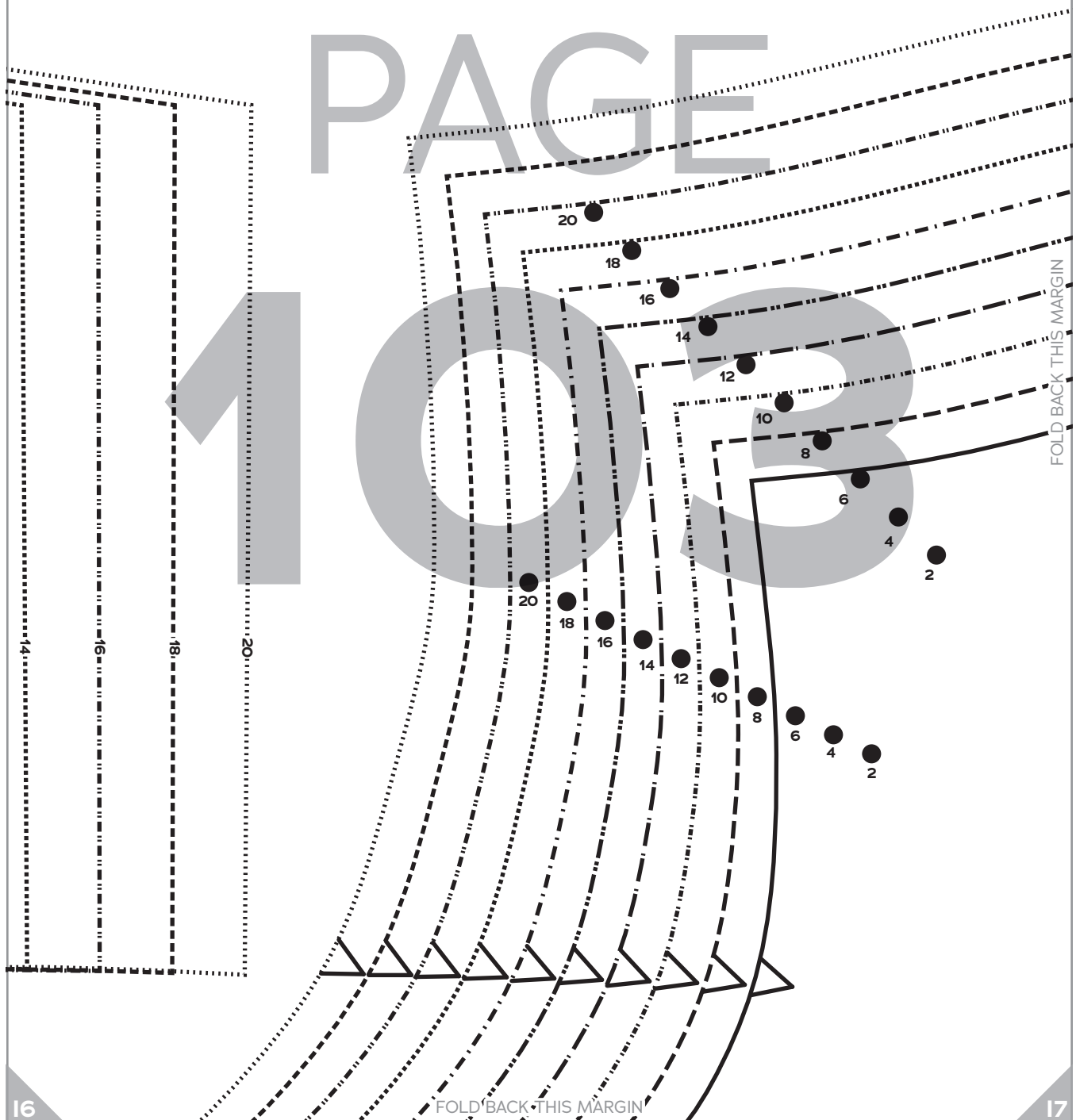

H7

H8

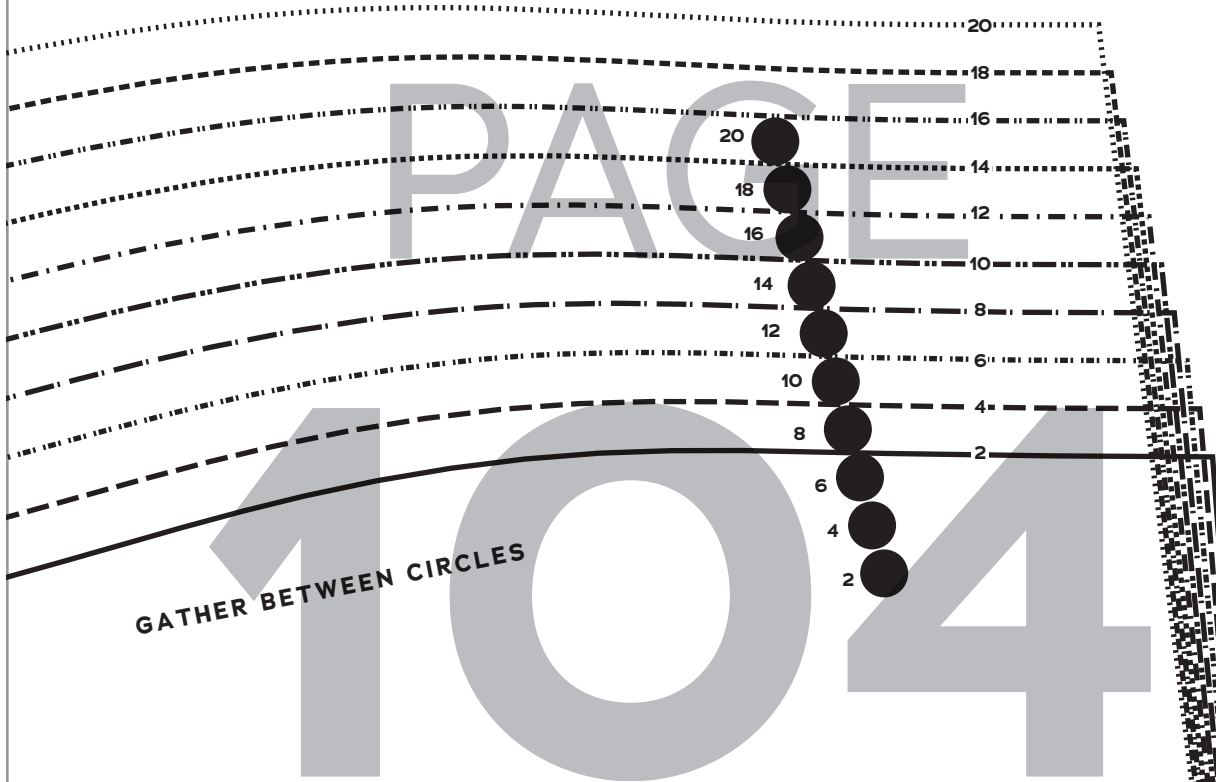

GATHER BETWEEN CIRCLES

FOLD BACK THIS MARGIN

I7

FOLD BACK THIS MARGIN

I8

H8

H9

PAGE 105

FOLD BACK THIS MARGIN

I8

FOLD BACK THIS MARGIN

I9

PAGE

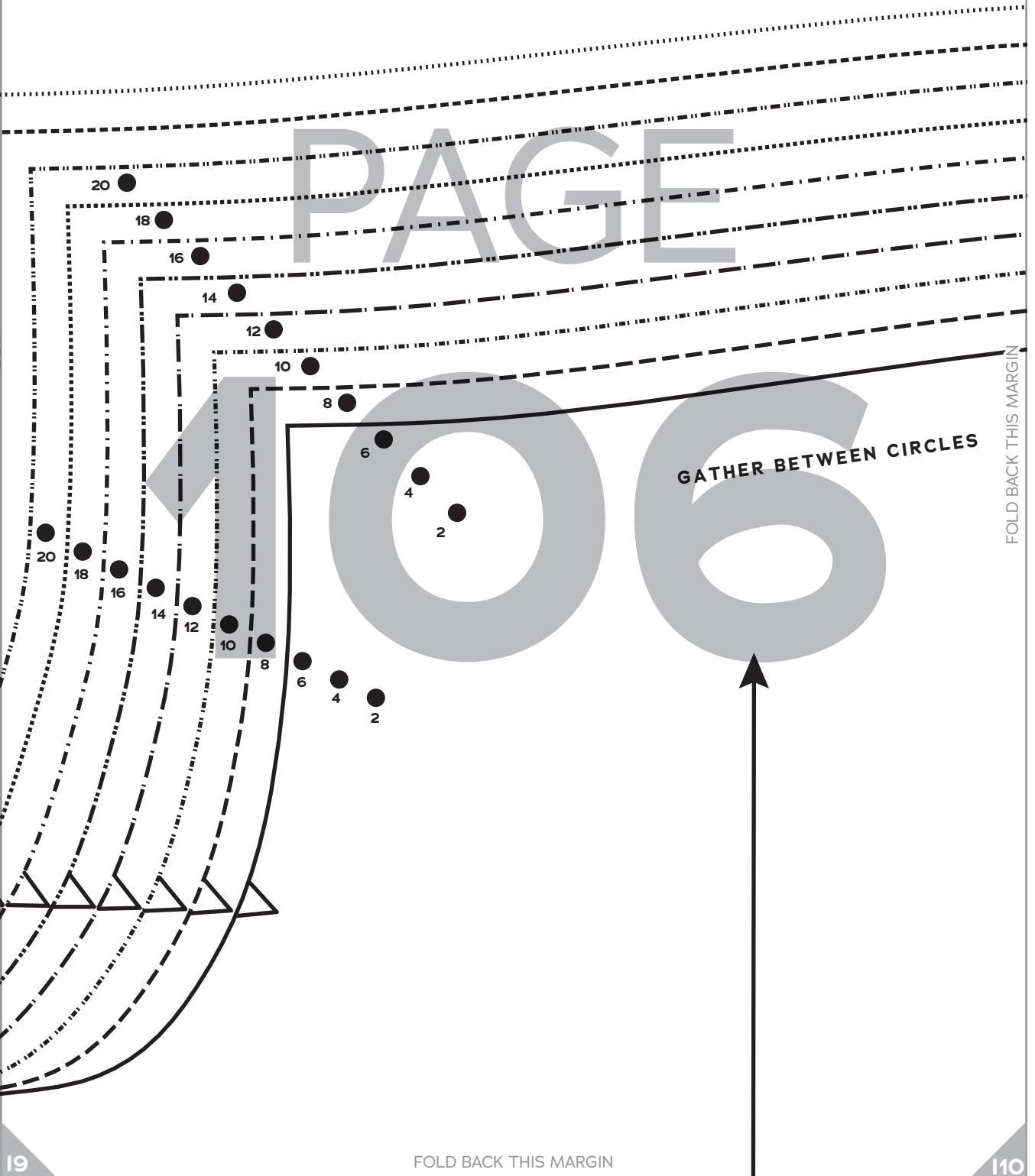

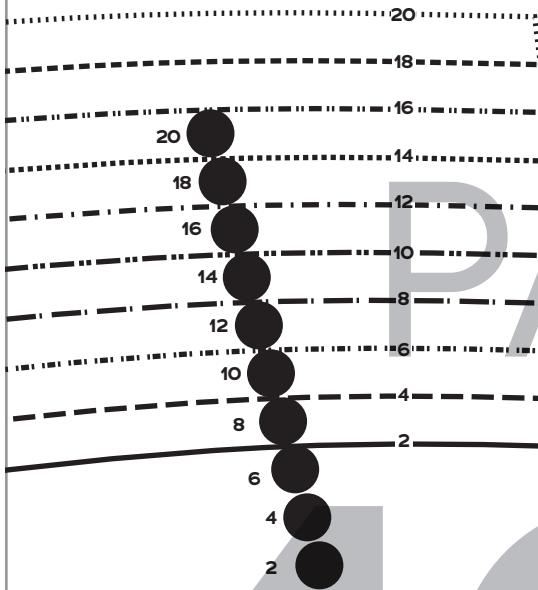

PAGE
107

FOLD BACK THIS MARGIN



PAGE

GATHER BETWEEN CIRCLES

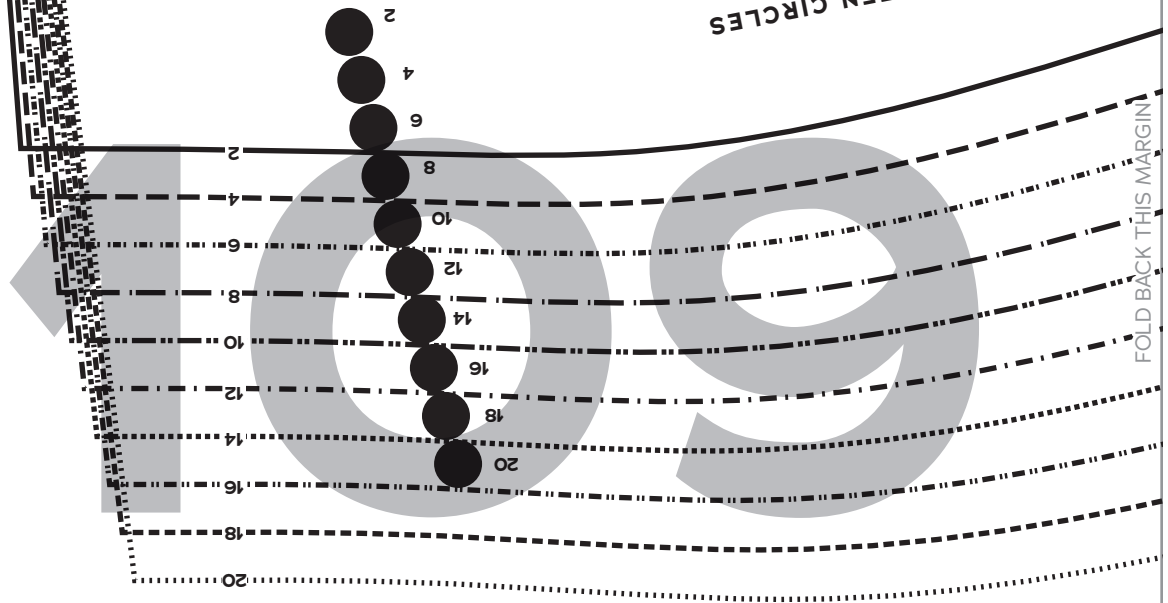

FOLD BACK THIS MARGIN

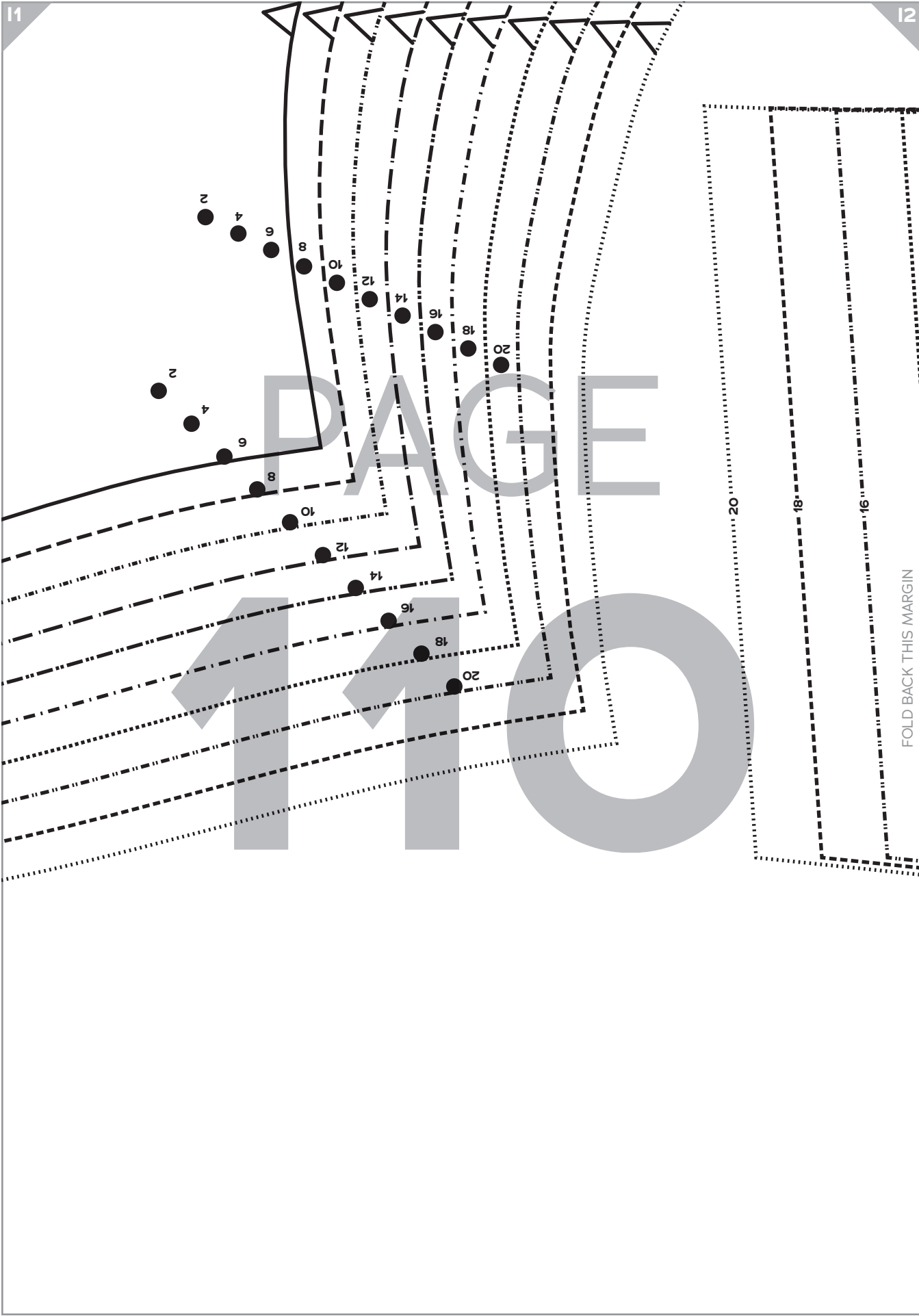

PAGE

111

FOLD BACK THIS MARGIN



13

14

GRAINLINE

Society
of CHARM

Society

DRESS

SIZES 2-20

1

Bodice Front,

B/C Cup

Cut 2 fabric

20
10
2

PAGE

112

FOLD BACK THIS MARGIN

PAGE

GATHER BETWEEN CIRCLES



FOLD BACK THIS MARGIN

FOLD BACK THIS MARGIN

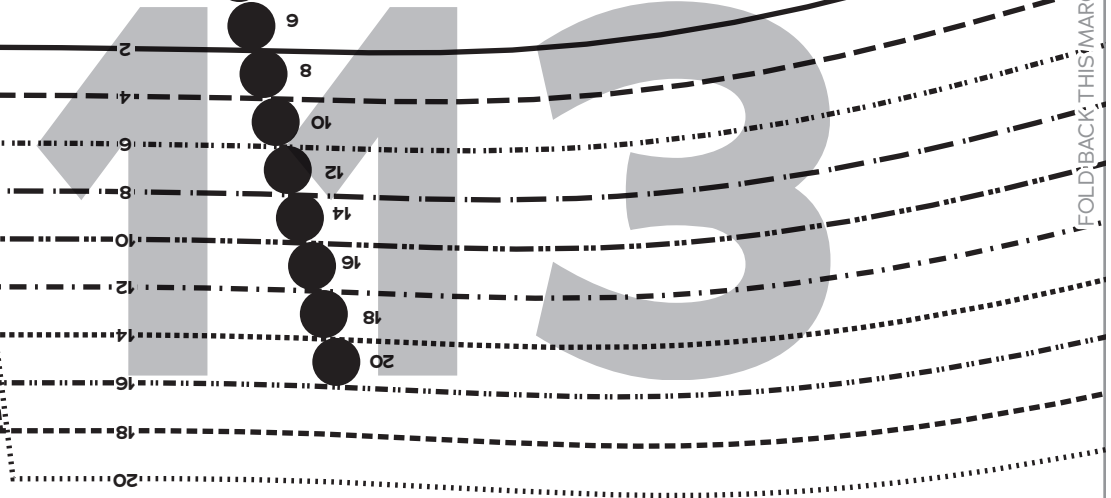
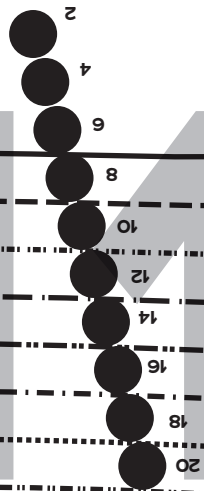

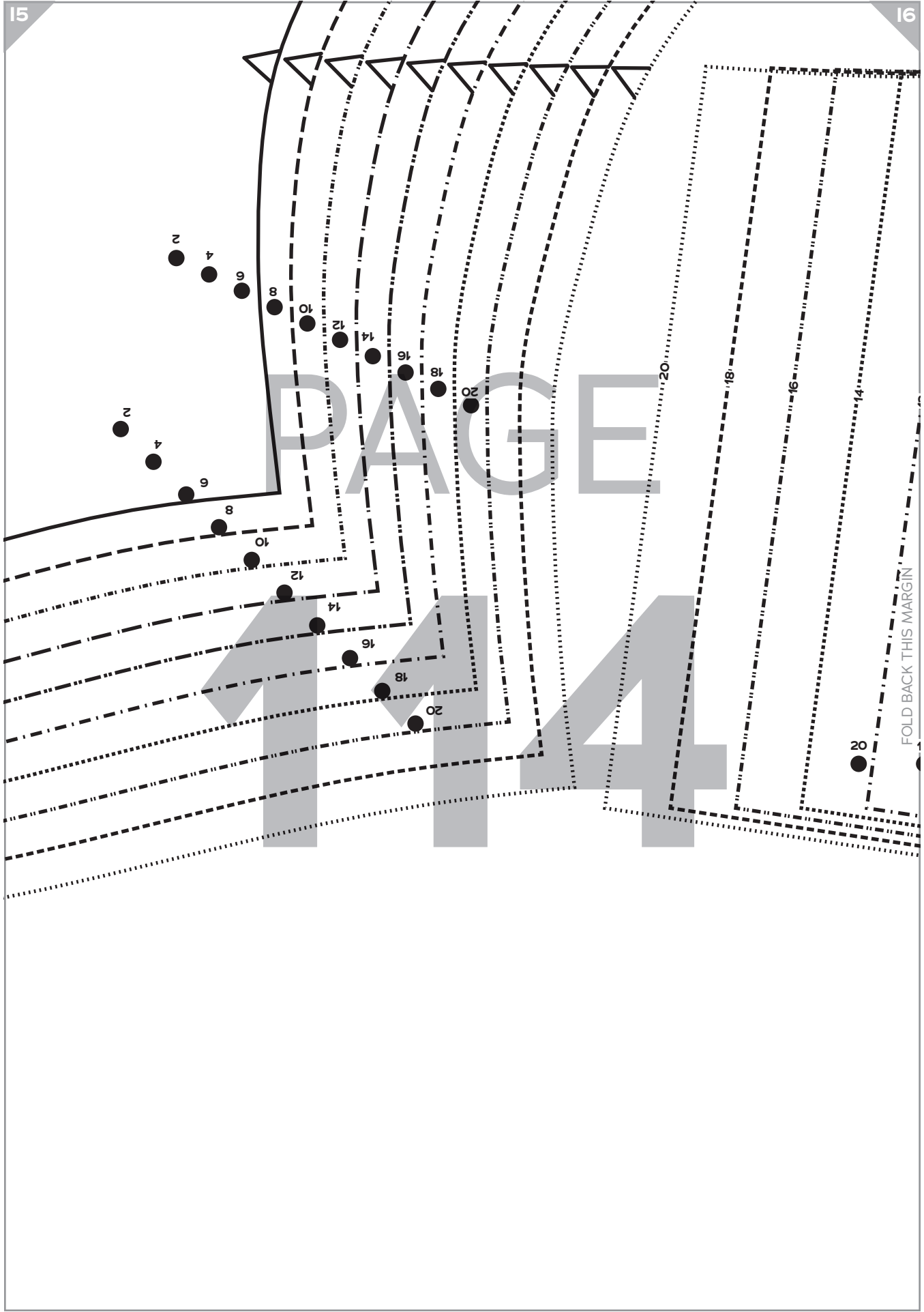



17

18

GRAINLINE

Society
of CHARM

Society

DRESS

SIZES 2-20

1

Bodice Front,
F/G Cup

Cut 2 fabric



PAGE

116

FOLD BACK THIS MARGIN

CUT BETWEEN CIRCLES

20

18

16

14

12

10

8

6

4

2

PAGE

20

18

16

14

12

10

8

6

4

FOLD BACK THIS MARGIN

GRAINLINE

PAGE



2 ●

118

GATHER BETWEEN CIRCLES

FOLD BACK THIS MARGIN



Society
of CHARM

Society

DRESS

SIZES 2-20

1

Bodice Front,
H Cup

Cut 2 fabric



PAGE

119

FOLD BACK THIS MARGIN

