

CAMP Gertie
CHARM SCOUT

Scout Dress

Sizes 2-20
with cup sizes A-H

1/8 inch (1.5 cm) seam allowances are included on all pattern pieces.

PAGE 1 OF 4

PATTERN PIECE INDEX

1	Bodice Front, A Cup
1	Bodice Front, B/C Cup
1	Bodice Front, D/DD Cup
6	Sleeve
7	Sleeve Band

SIZES 2-20 PATTERN SIZE KEY

2	----
4	-----
6	-----
8	-----
10	-----
12	-----
14	-----
16	-----
18	-----
20	-----

SYMBOL KEY

grainline arrow
match point/
placement mark

1 in test square 2 cm test square

© 2023 Charm Patterns by Gertie. Distribution and Commercial Use Prohibited.



Scout Dress

Sizes 2-20

with cup sizes A-H

5/8 inch (1.5 cm) seam allowances are included on all pattern pieces.

PAGE 2 OF 4

PATTERN PIECE INDEX

- 1 Bodice Front, F/G Cup
- 9 Sleeveless Bias Facing
- 12 Skirt Back
- 14 Skirt Front Interfacing

SIZES 2-20

PATTERN

SIZE KEY

- 2 - - - - -
- 4 - - - - -
- 6 - - - - -
- 8 - - - - -
- 10 - - - - -
- 12 - - - - -
- 14 - - - - -
- 16 - - - - -
- 18 - - - - -
- 20 - - - - -

SYMBOL KEY

grainline arrow

match point/

placement mark

●

1 in
test
square

2 cm
test
square

© 2022 Charm
Patterns
by Gertie
Distribution
and Commercial
Use Prohibited

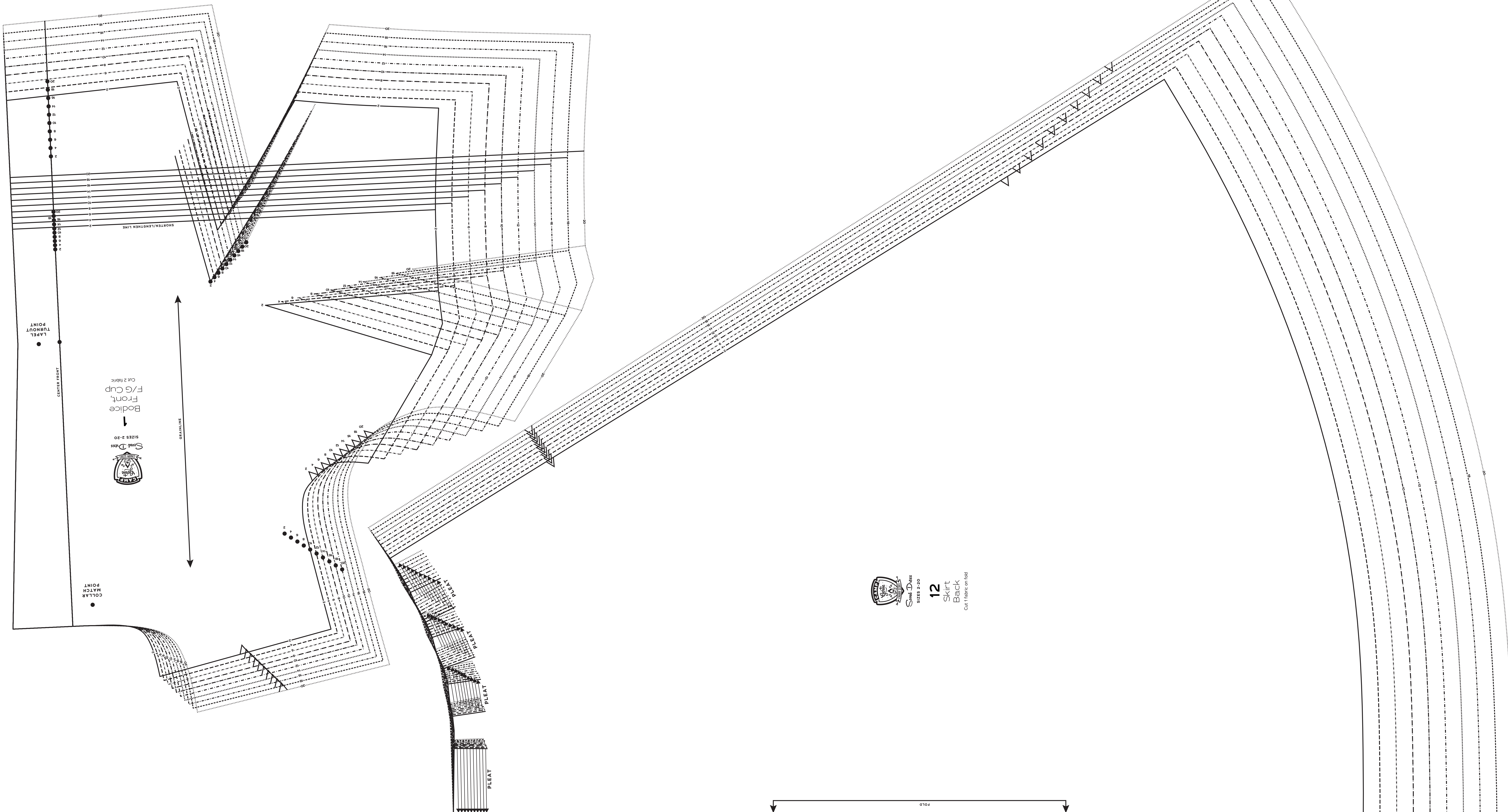
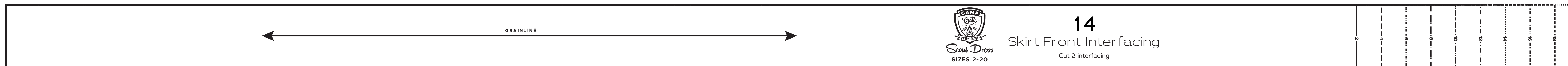

12
Skirt
Back
Cut 1 fabric on fold



Scout Dress

SIZES 2-20
with cup sizes A-H

1/4 inch (1.5 cm) seam allowances
are included on all pattern pieces.

PAGE 3 OF 4

PATTERN PIECE INDEX

2	Bodice Back
4	Bodice Back Neck Facing
5	Collar
8	Sleeve Keyhole Binding
11	Skirt Side Front/Back

**SIZES 2-20
PATTERN
SIZE KEY**

2	-----
4	-----
6	-----
8	-----
10	-----
12	-----
14	-----
16	-----
18	-----
20	-----

SYMBOL KEY
grainline arrow

match point/
placement mark

1 in
test
square

2 cm
test
square

©2023 Charn
Patterns
by Gertie
Distribution
and Commercial
Use Prohibited

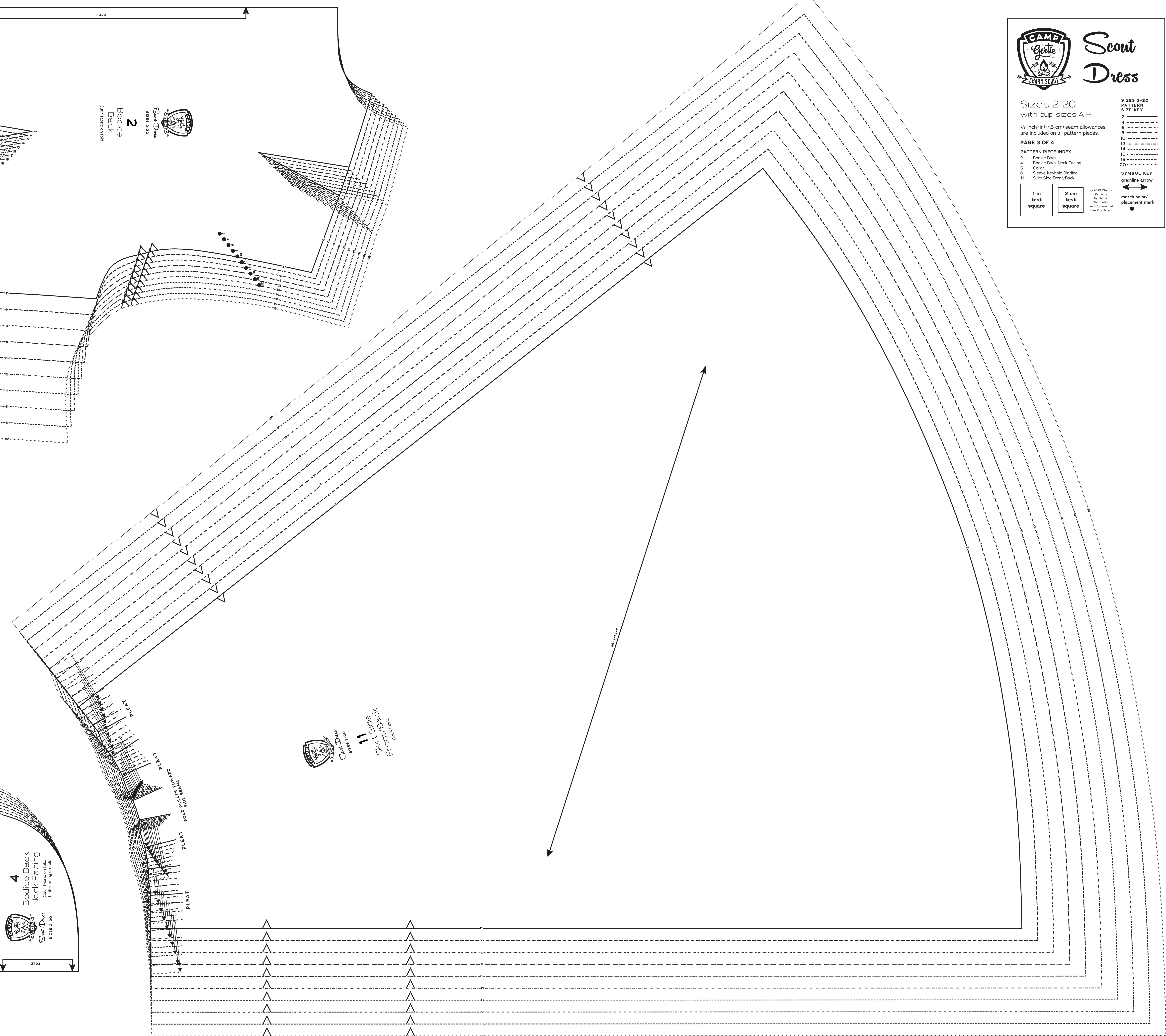
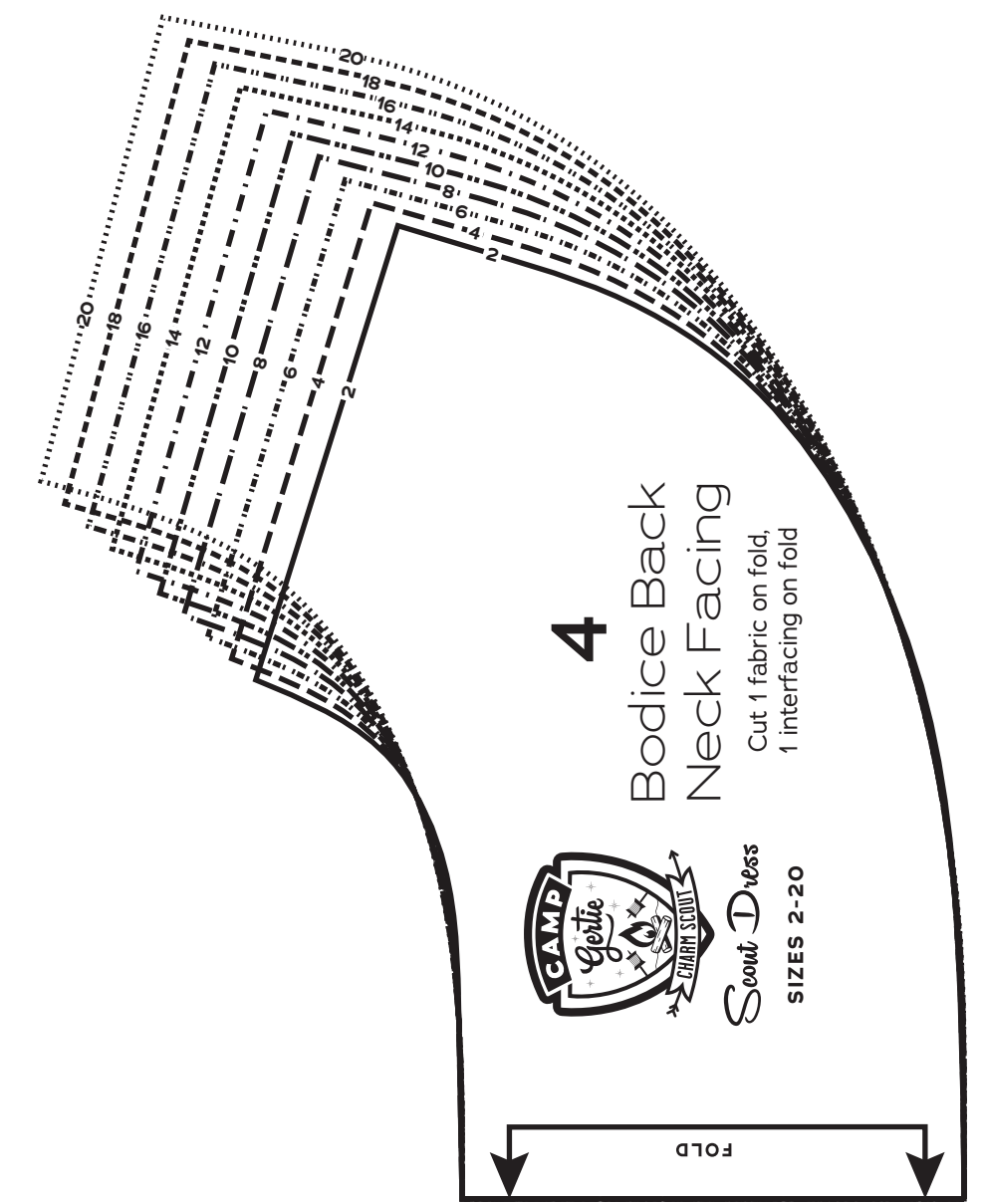
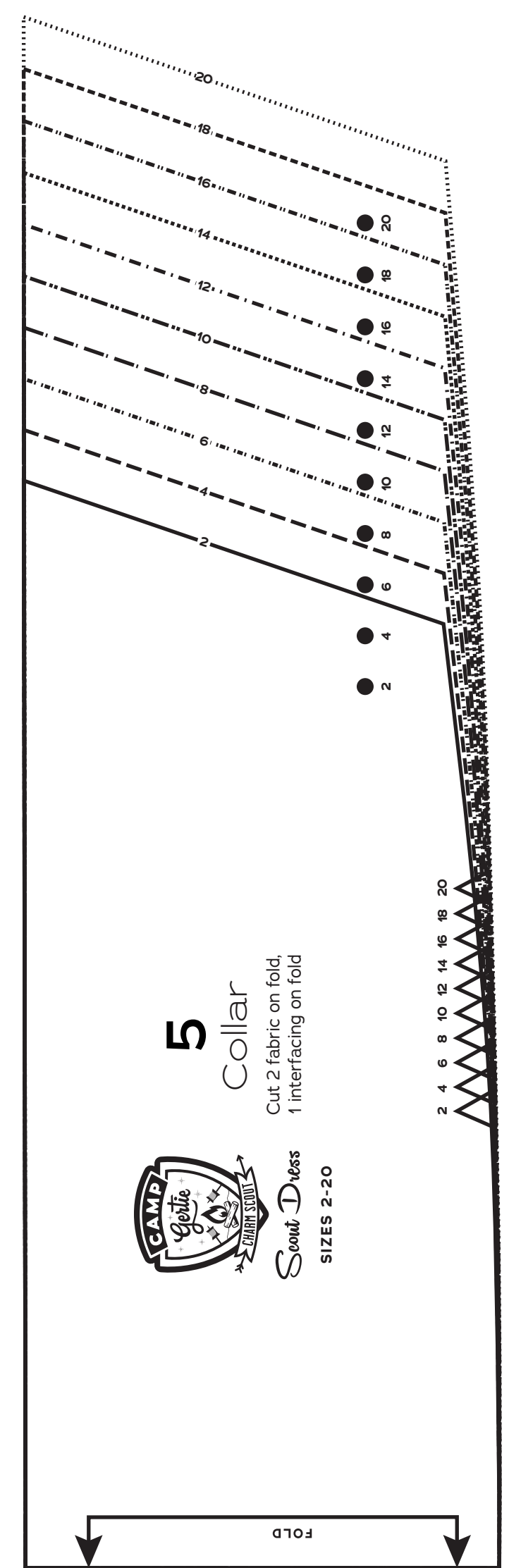
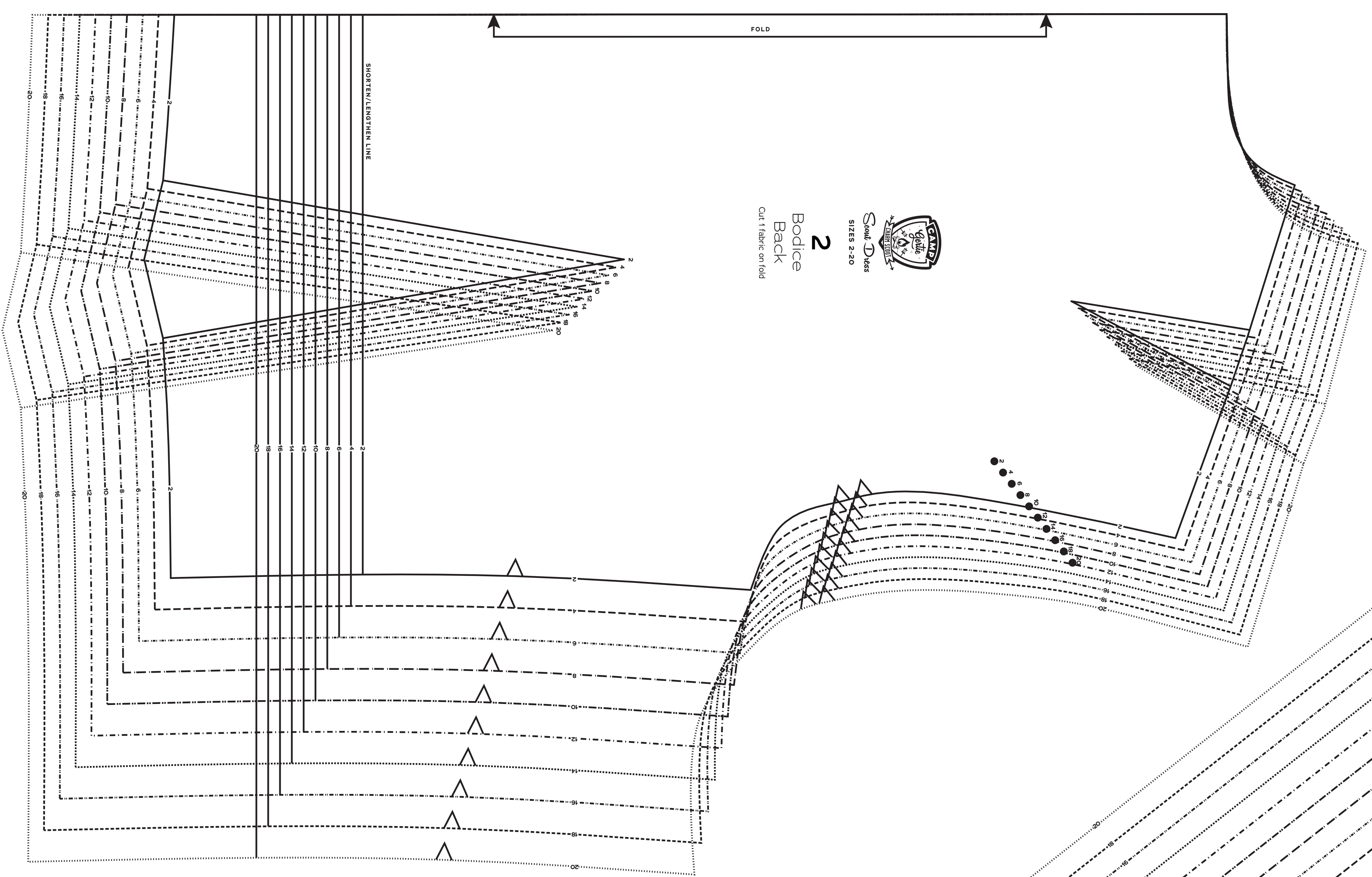



Scout Dress

Sizes 2-20
with cup sizes A-H

1/4 inch (1.5 cm) seam allowances
are included on all pattern pieces.

PAGE 4 OF 4

PATTERN PIECE INDEX

- 1 Bodice Front, H Cup
- 3 Bodice Front Facing, All Cups
- 10 Skirt Front
- 13 Pocket Bag

SIZES 2-20 PATTERN SIZE KEY

- 2
- 4
- 6
- 8
- 10
- 12
- 14
- 16
- 18
- 20

SYMBOL KEY

- grainline arrow
- match point/
placement mark

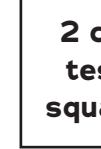
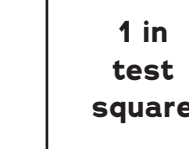

© 2023 Charm
Patterns
by Gerlie
Distribution
All Commercial
Use Prohibited

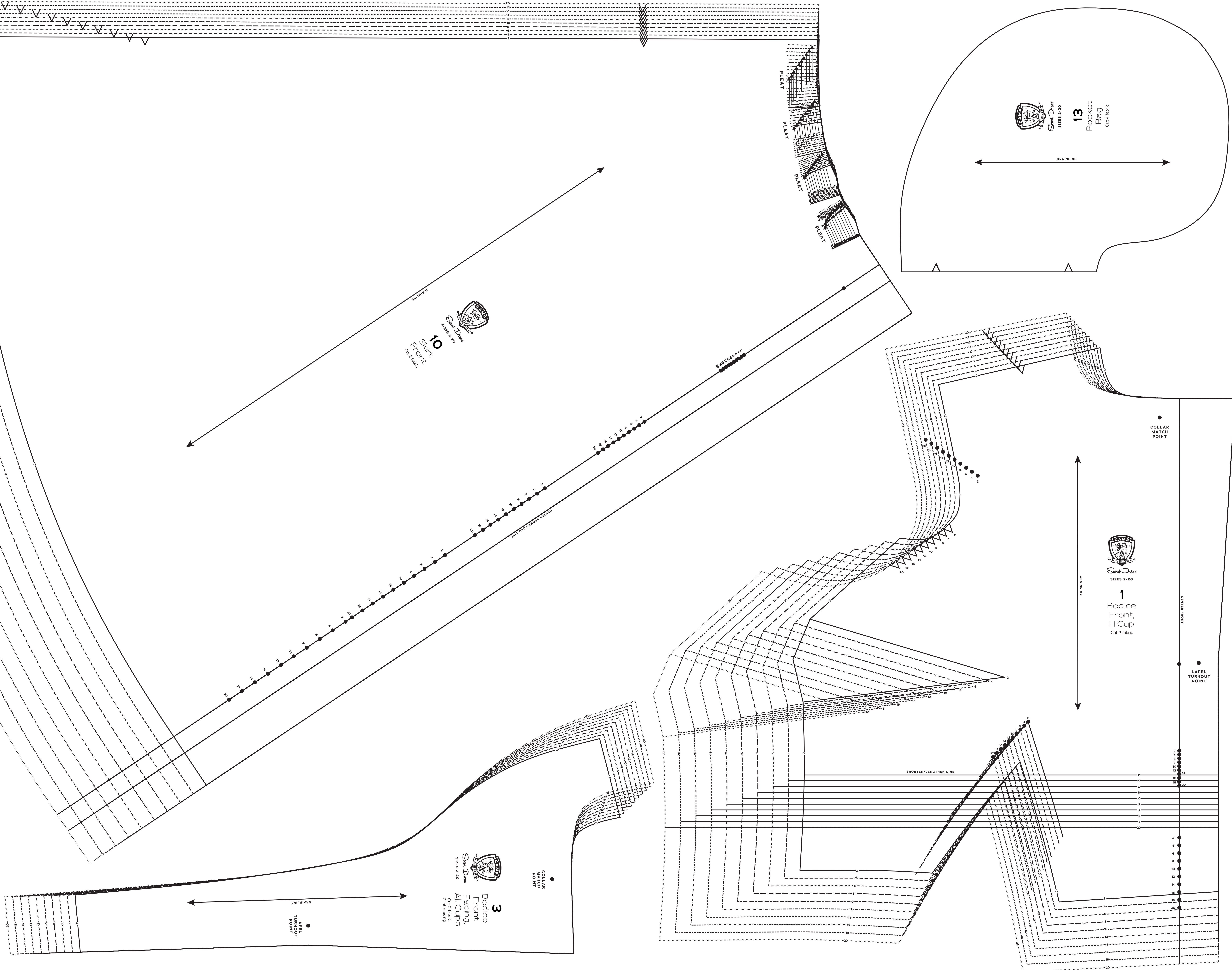

10
Skirt
Front
Cut 2 fabric
SIZES 2-20

13
Pocket
Bag
Cut 1 fabric
SIZES 2-20

3
Bodice
Front
Facing,
All CUPS
Cut 2 fabric,
2 interfacing
SIZES 2-20

1
Bodice
Front,
H Cup
Cut 2 fabric
SIZES 2-20

1 in test square
2 cm test square

match point/
placement mark

© 2023 Charm
Patterns
by Gerlie
Distribution
All Commercial
Use Prohibited