

Rizzo

JACKET

Sizes 18-34
with cup sizes A-H

5/8 inch (in) (1.5 cm) seam allowances are included on all pattern pieces.

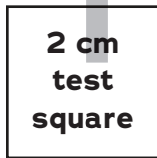
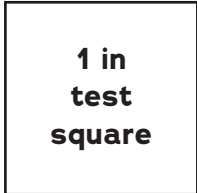

SIZE 18-34
PATTERN
SIZE KEY

18	-----
20
22
24	-----
26
28	-----
30
32
34	-----

SYMBOL KEY

grainline arrow



● match point/
placement mark

⊕ bust apex

✕ button/buttonhole

© 2023 Charm Patterns by
Gertie. Distribution and
Commercial Use Prohibited.

PAGE

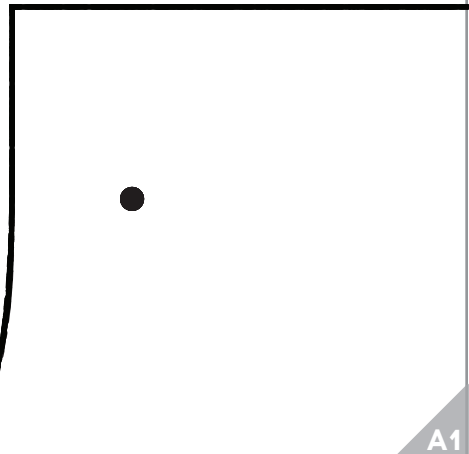



PAGE



FOLD BACK THIS MARGIN

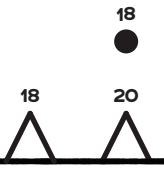

A1

FOLD BACK THIS MARGIN

A2

PAGE

Society
of CHARM
Rizzo
JACKET
SIZES 18-34

7
Sleeve
Cuff
Cut 4 fabric,
2 interfacing

GRAINLINE

22 24 26 28 30 32 34

● 20 ● 22 ● 24 ● 26 ● 28 ● 30 ● 32 ● 34

● 20 ● 22 ● 24 ● 26 ● 28 ● 30 ● 32 ● 34

22 24 26 28 30 32 34

FOLD BACK THIS MARGIN

3

A2

FOLD BACK THIS MARGIN

A3

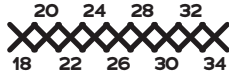

UNDERLAP

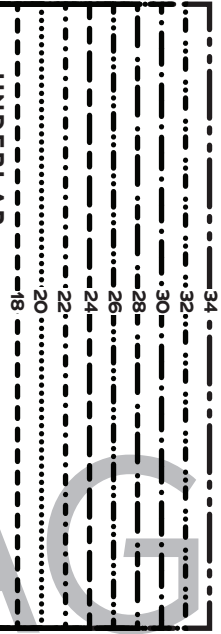

PAGE

4

FOLD BACK THIS MARGIN

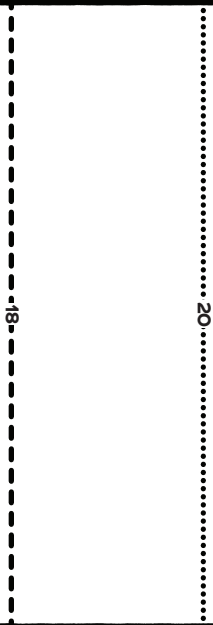

A3

FOLD BACK THIS MARGIN

A4



PAGE

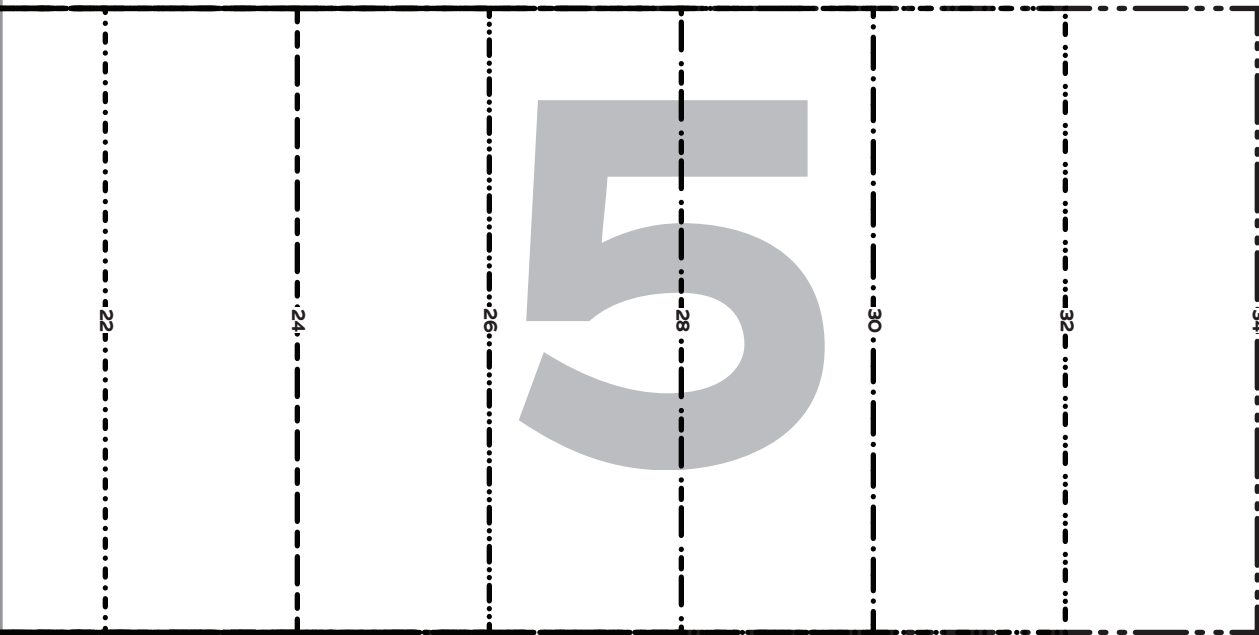

FOLD BACK THIS MARGIN

A4

FOLD BACK THIS MARGIN

A5

FOLD BACK THIS MARGIN

PAGE
6

*Society
of CHARM*
Rizzo

JACKET
SIZES 18-34

9

Front Facing
Cut 2 fabric, 2 interfacing

A6

FOLD BACK THIS MARGIN

A5

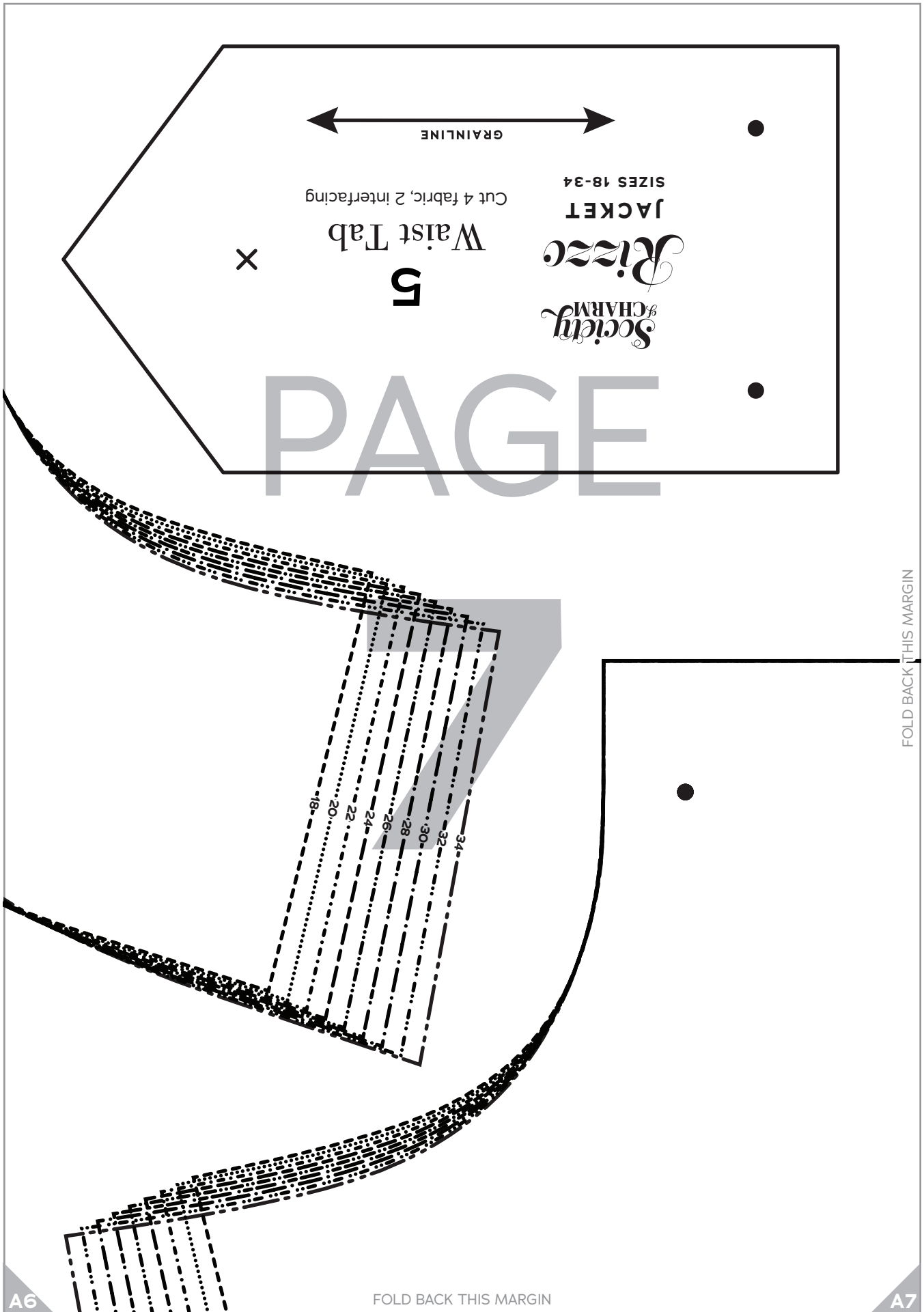

PAGE

FOLD BACK THIS MARGIN

A6

FOLD BACK THIS MARGIN

A7

Society
of CHARM
Rizzo

JACKET
SIZES 18-34

1

**Jacket Front,
H Cup**
Cut 2 fabric

FOLD BACK THIS MARGIN

A8

Society
of CHARM
Rizzo

JACKET
SIZES 18-34

8

Collar

Cut 2 fabric on fold,
1 interfacing on fold

PAGE

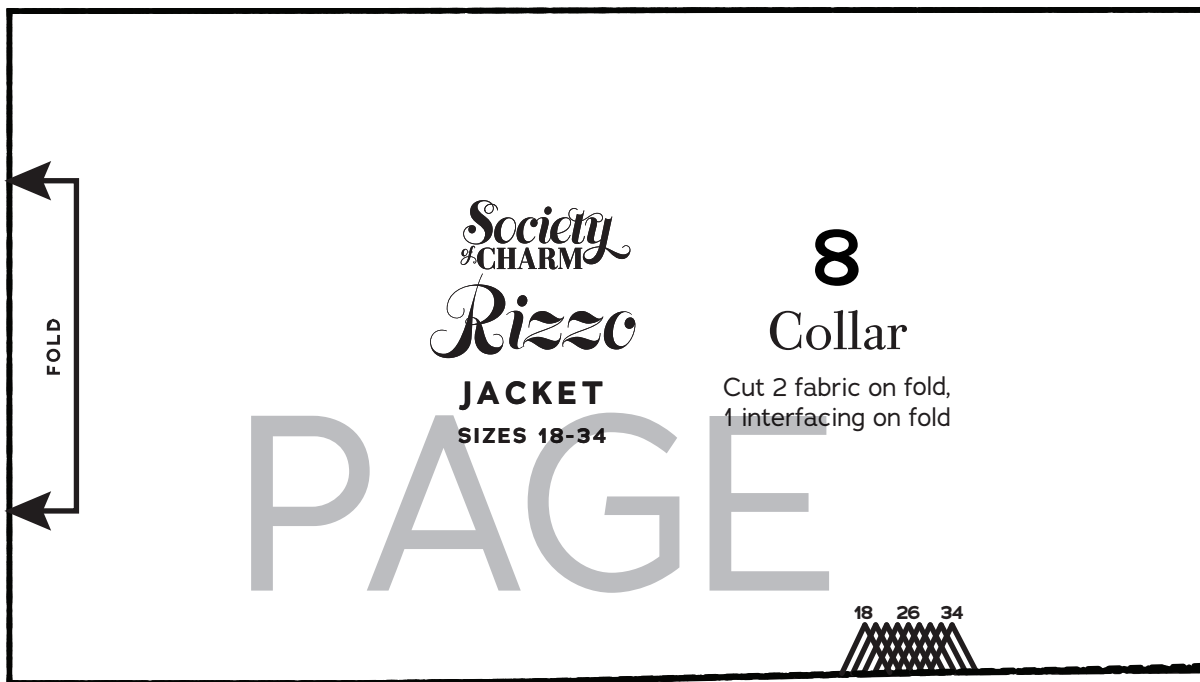

FOLD BACK THIS MARGIN

8

A7

PAGE

18 20 22 24 26 28 30 32 34

18 20 22 24 26 28 30 32 34

9

FOLD BACK THIS MARGIN

A8

FOLD BACK THIS MARGIN

A9

PAGE



FOLD BACK THIS MARGIN

18
20
22
24
26
28
30
32
34

A9

FOLD BACK THIS MARGIN

A10

FOLD BACK THIS MARGIN



WELT POCKET

GRAINLINE



PAGE 11

Lining Front,
A/B Cup
Cut 2 lining

JACKET
SIZES 18-34

Society of Charm
Rizzo

10

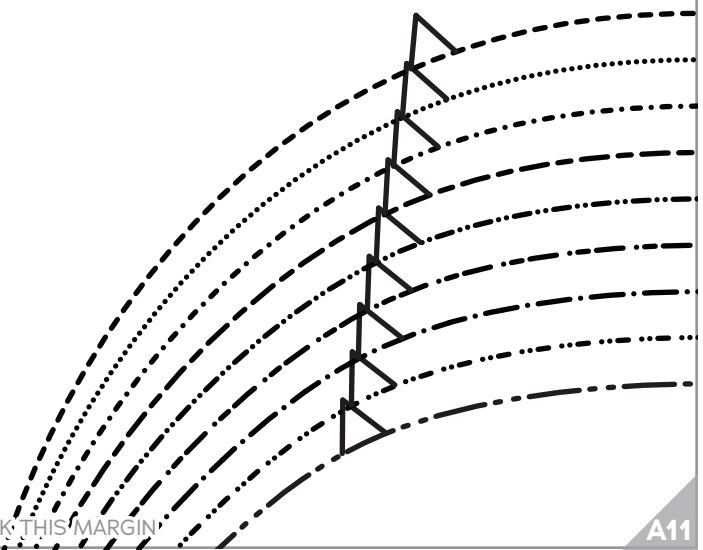

FOLD BACK THIS MARGIN

A10

A11

PAGE

12

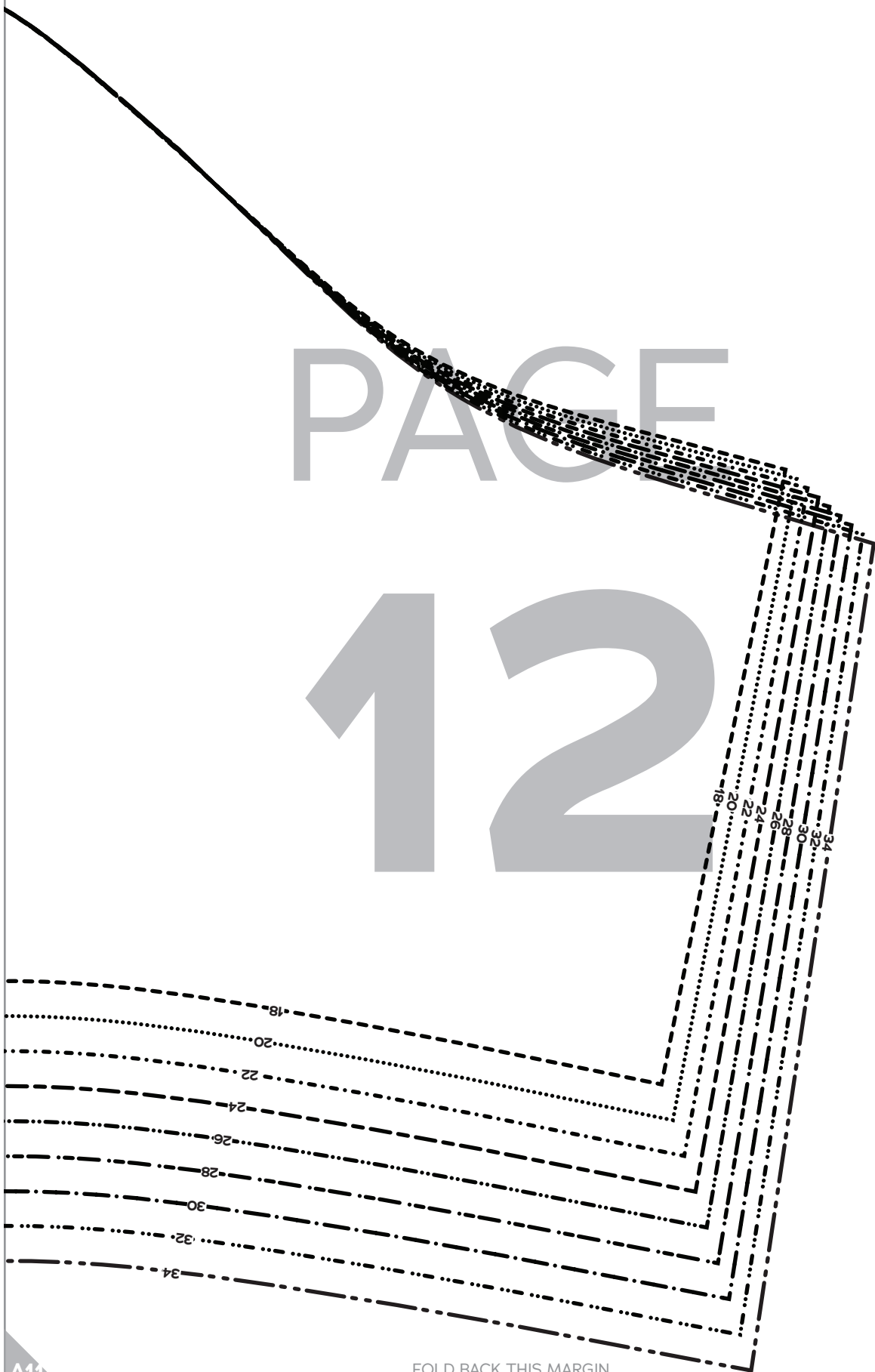

A11

FOLD BACK THIS MARGIN

PAGE

13

FOLD BACK THIS MARGIN

FOLD BACK THIS MARGIN

A1

A2

Society
of
CHARM
Rizzo

JACKET
SIZES 18-34

1

Jacket Front,
A/B Cup
Cut 2 fabric

GRAINLINE

PAGE

14

FOLD BACK THIS MARGIN

B1

FOLD BACK THIS MARGIN

B2

A2

A3

343230282624 222018

343230282624 222018

PAGE
15

FOLD BACK THIS MARGIN

B2

FOLD BACK THIS MARGIN

B3

A3

A4

PAGE

16

FOLD BACK THIS MARGIN

FOLD BACK THIS MARGIN

B4

B3

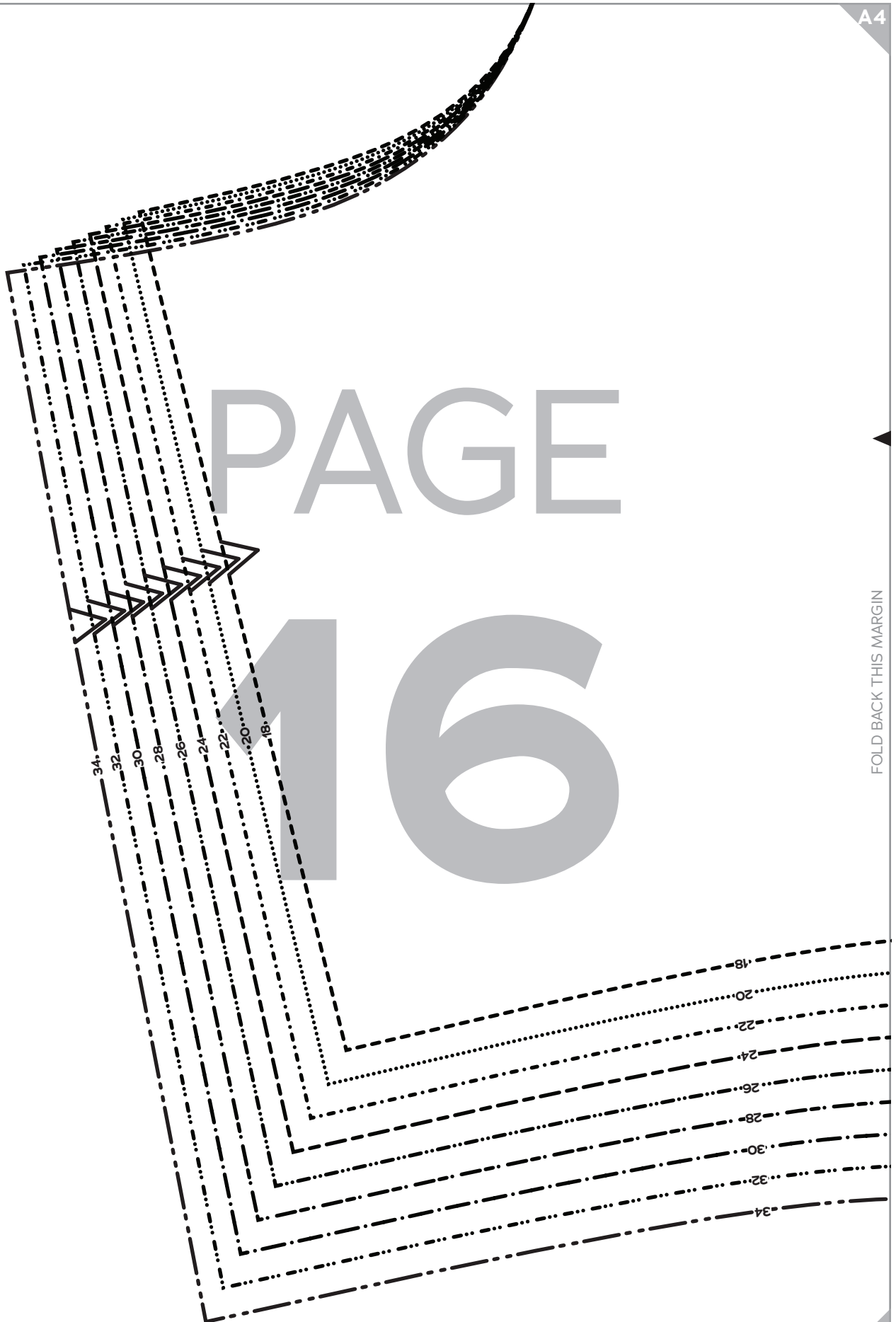

A4

A5

Society
of
CHARM
Rizzo

JACKET
SIZES 18-34

1

Jacket Front,
D/DD Cup
Cut 2 fabric

GRAINLINE

PAGE

17

FOLD BACK THIS MARGIN

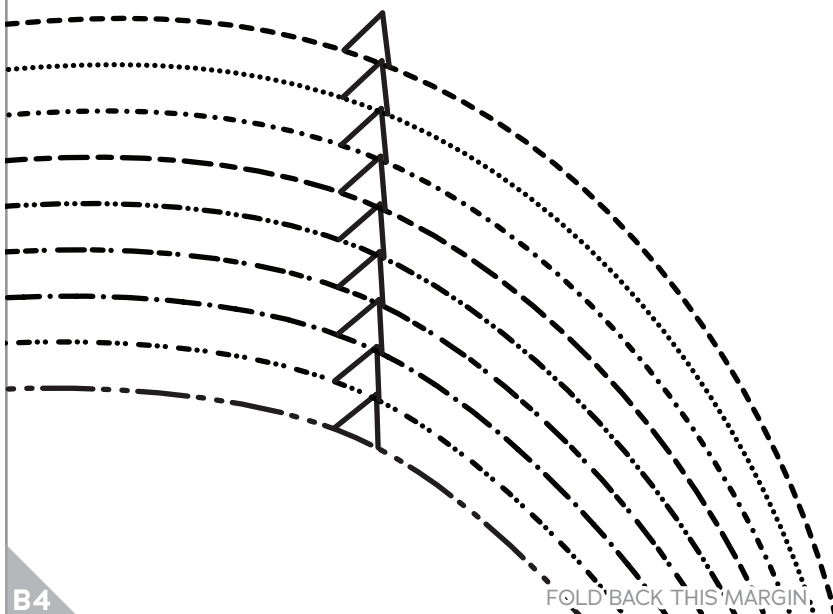

B4

B5

A5

A6

343230282624 222018

343230282624 222018

PAGE
18

FOLD BACK THIS MARGIN

B5

FOLD BACK THIS MARGIN

B6

A6

A7

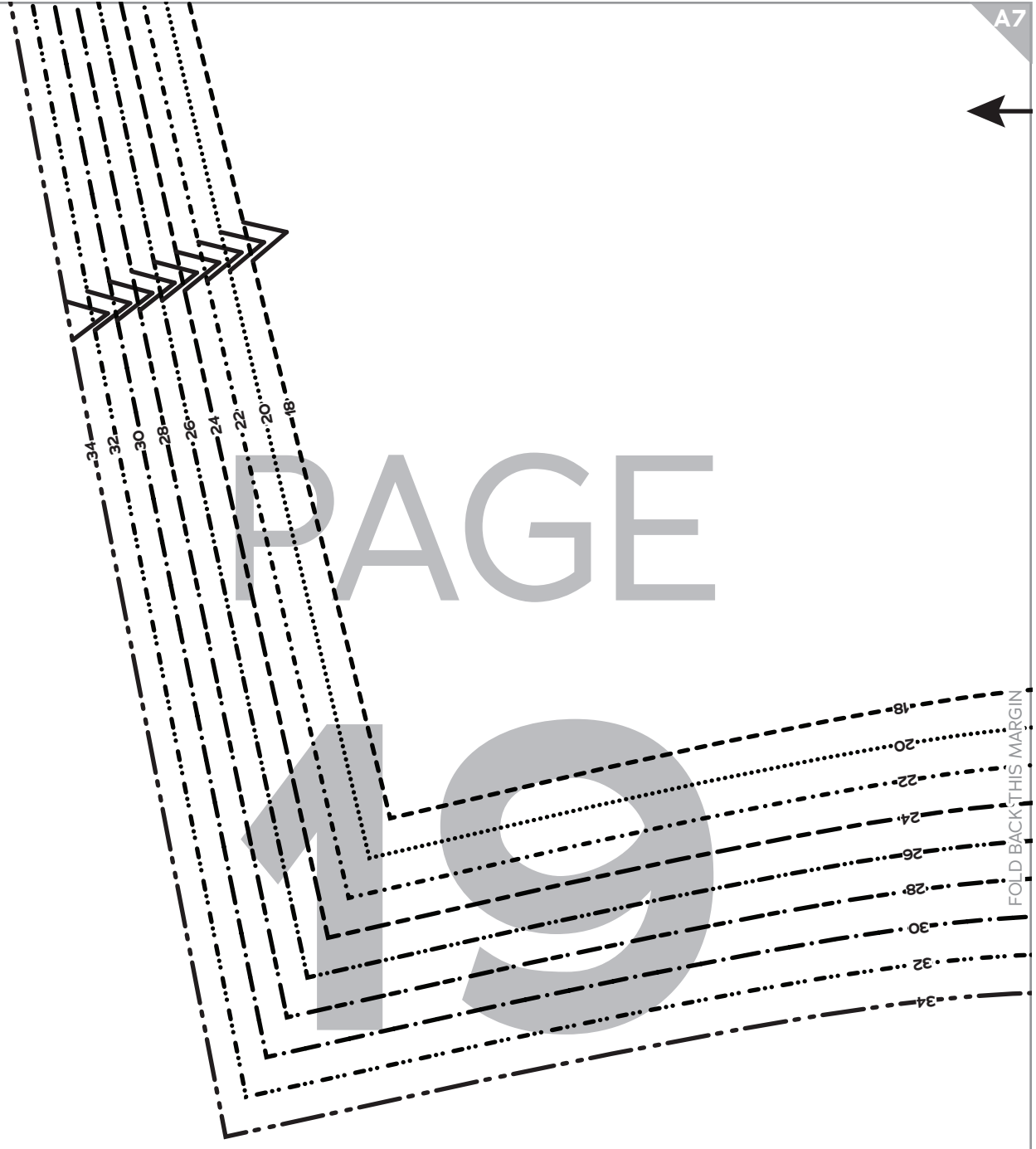

FOLD BACK THIS MARGIN

FOLD BACK THIS MARGIN

B6

B7

A7

A8

GRAINLINE



PAGE

FOLD BACK THIS MARGIN

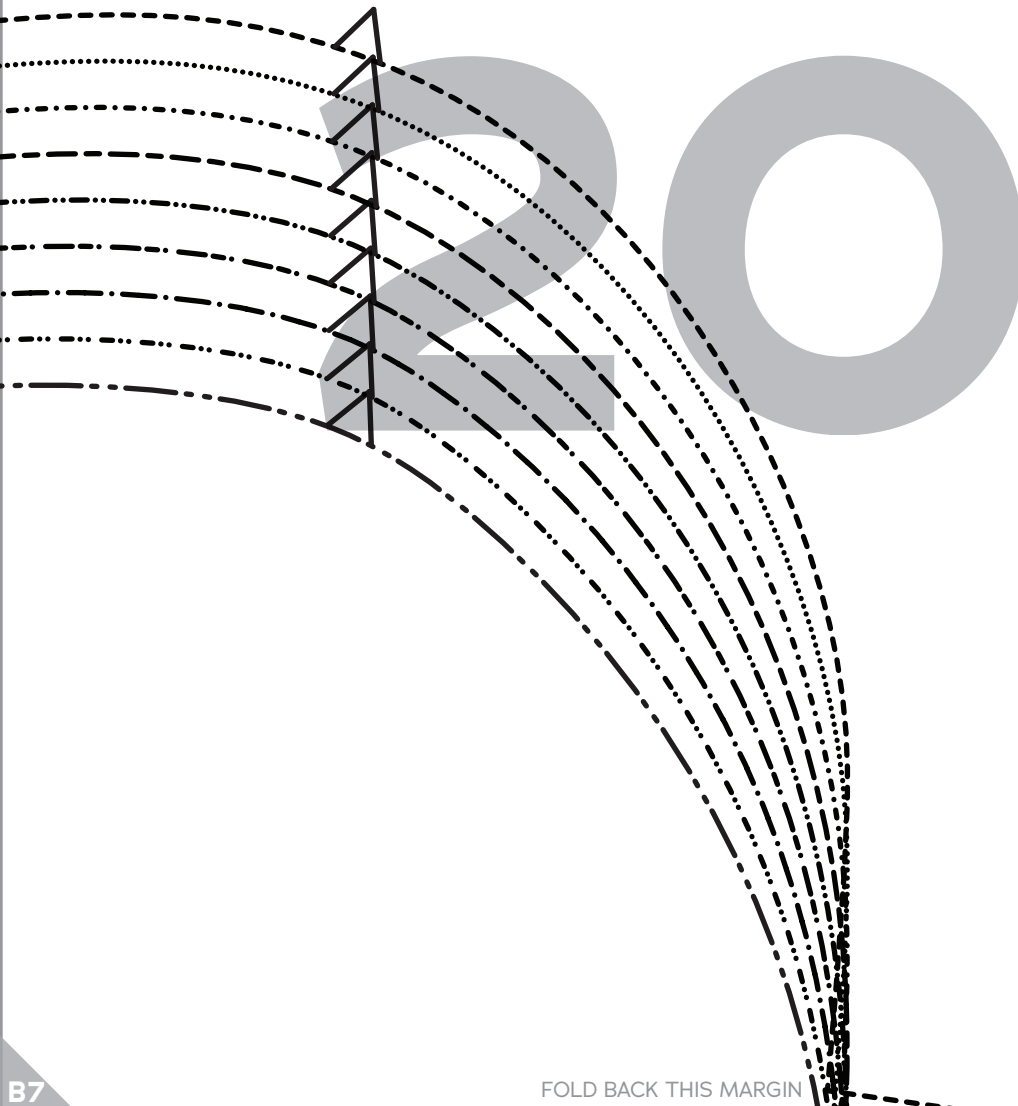

FOLD BACK THIS MARGIN

B7

B8

A8

A9

343230282624 222018

343230282624 222018

PAGE

21

FOLD BACK THIS MARGIN

B8

FOLD BACK THIS MARGIN

B9

A9

A10

PAGE

22

FOLD BACK THIS MARGIN

FOLD BACK THIS MARGIN

B10

B9

A10

A11

PAGE

23

FOLD BACK THIS MARGIN

FOLD BACK THIS MARGIN

B10

B11

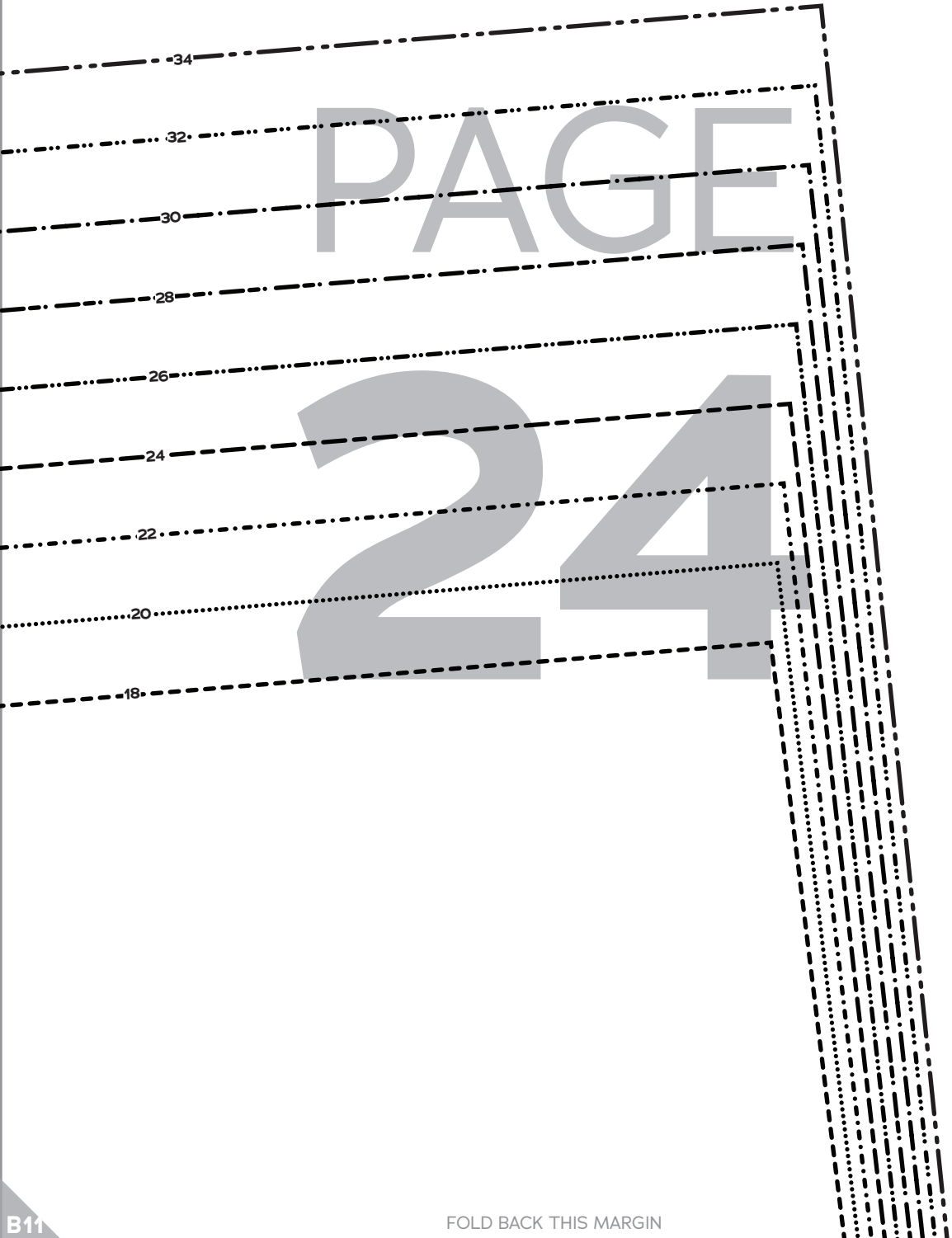

FOLD BACK THIS MARGIN

34

32

30

28

26

24

22

20

18

PAGE

25

FOLD BACK THIS MARGIN

FOLD BACK THIS MARGIN

B1

B2

PAGE
26

FOLD BACK THIS MARGIN

C1

FOLD BACK THIS MARGIN

C2

B2

B3

PAGE

27

FOLD BACK THIS MARGIN

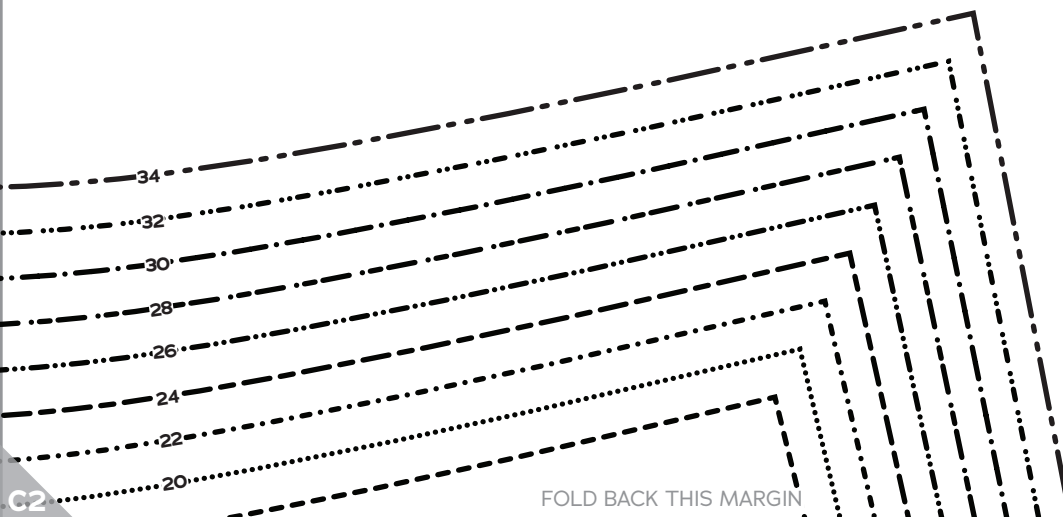

FOLD BACK THIS MARGIN

C2

C3

B3

B4

34

32

30

28

26

24

22

20

18

PAGE

28

FOLD BACK THIS MARGIN

C3

FOLD BACK THIS MARGIN

C4

B4

B5

PAGE

29

FOLD BACK THIS MARGIN

FOLD BACK THIS MARGIN

C4

C5

B5

B6

PAGE

30

FOLD BACK THIS MARGIN

C5

C6

FOLD BACK THIS MARGIN

B6

B7

PAGE

31

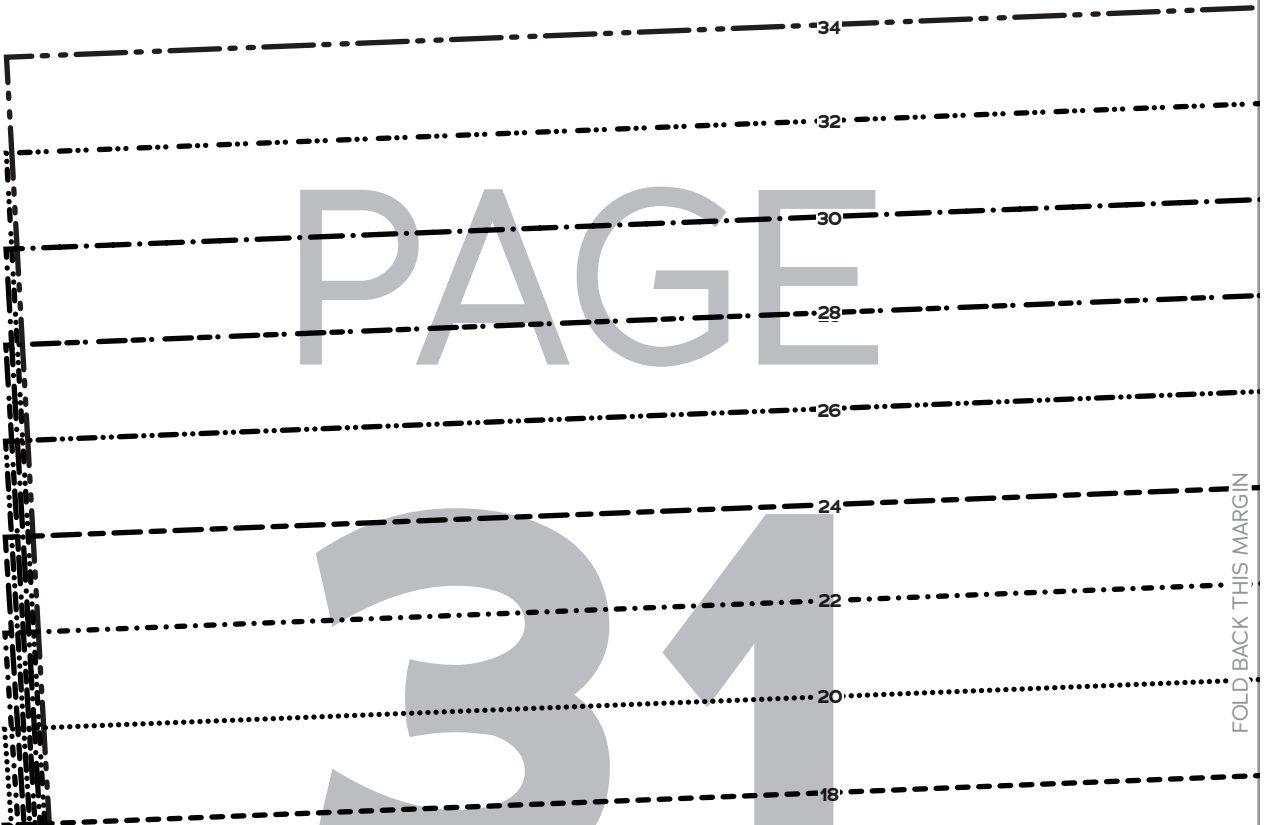

FOLD BACK THIS MARGIN

FOLD BACK THIS MARGIN

C6

C7

B7

B8

PAGE

32

FOLD BACK THIS MARGIN

C7

FOLD BACK THIS MARGIN

C8

B8

B9

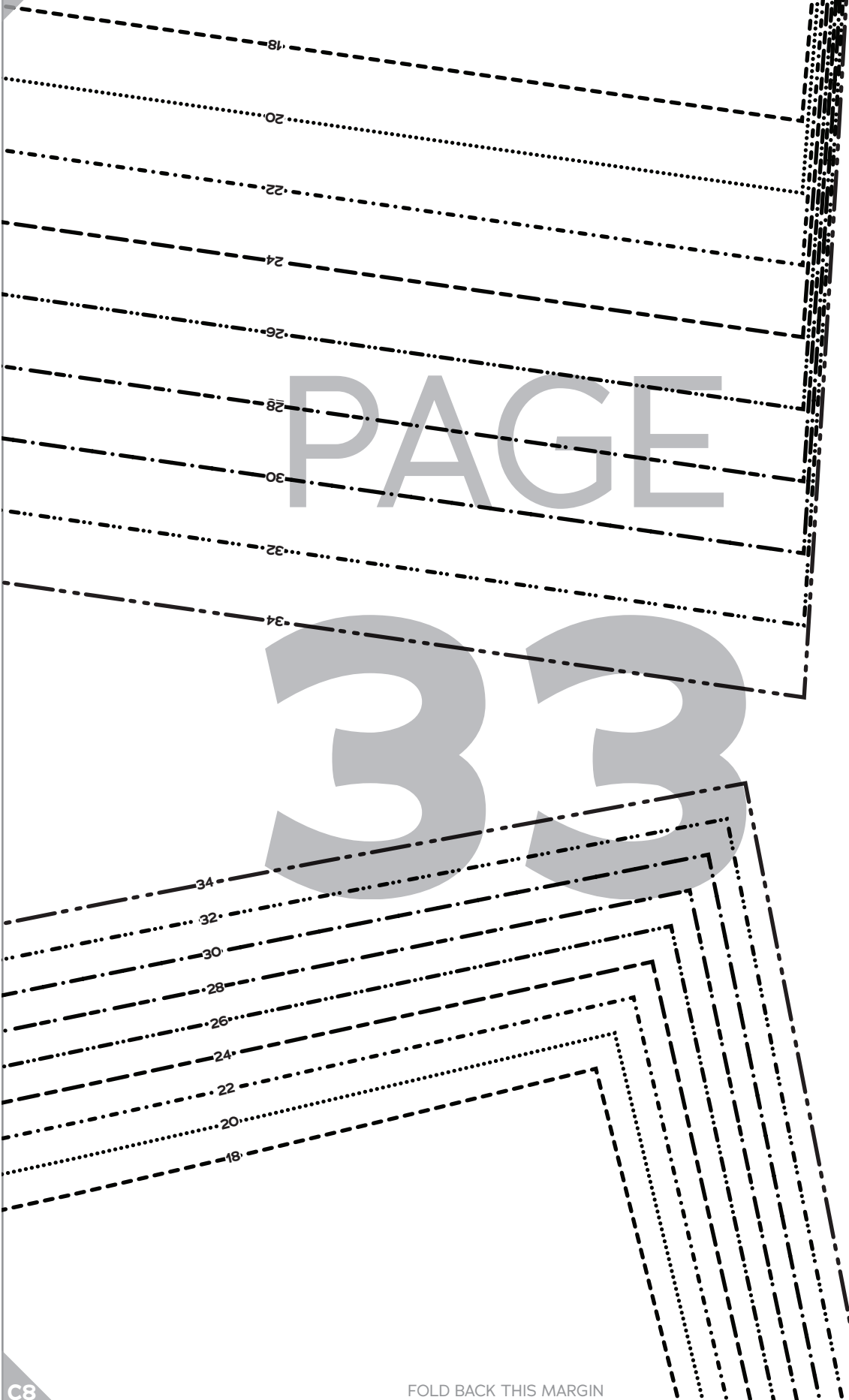

PAGE

33

FOLD BACK THIS MARGIN

C8

FOLD BACK THIS MARGIN

C9

B9

B10

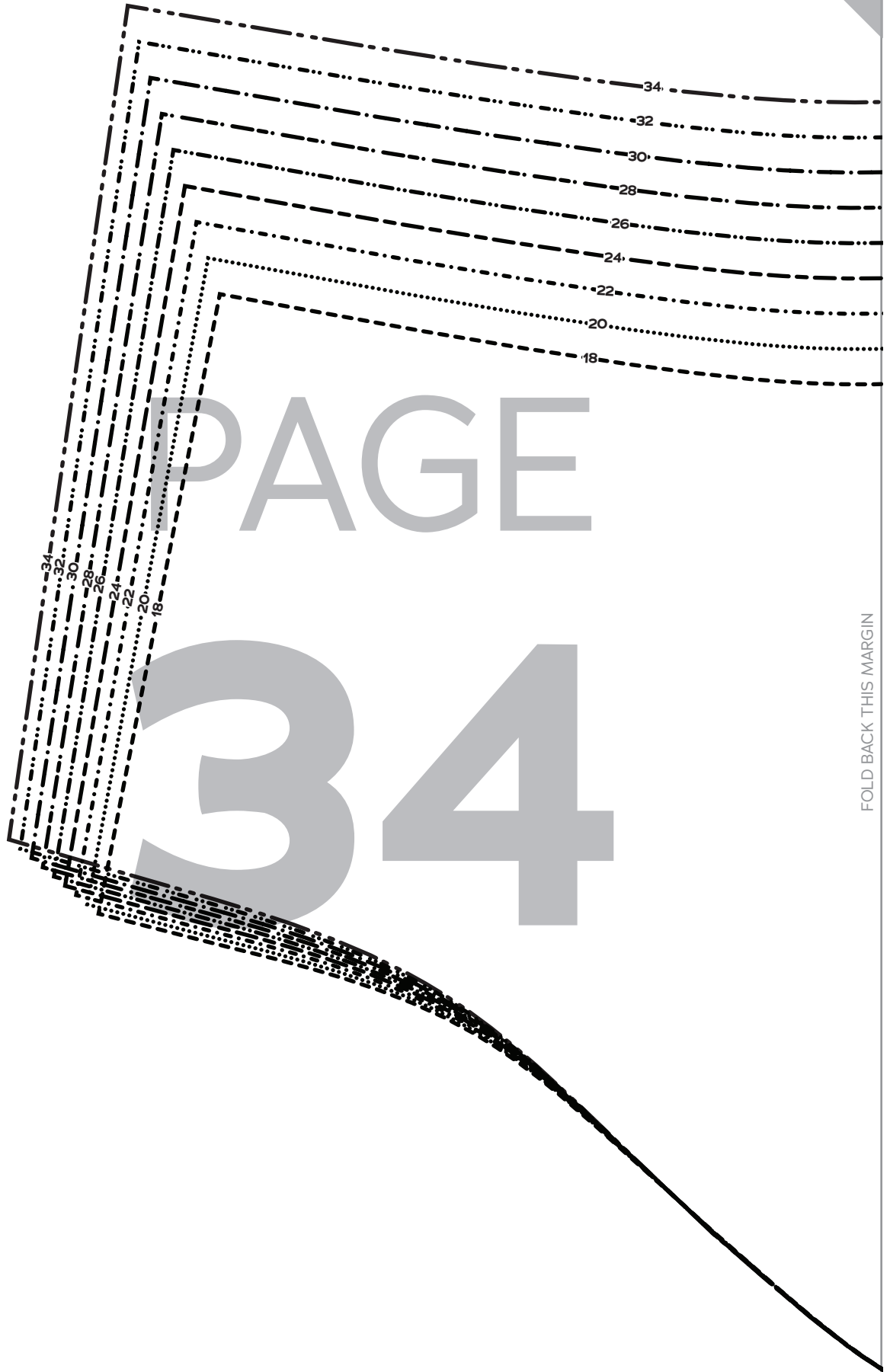

FOLD BACK THIS MARGIN

C9

FOLD BACK THIS MARGIN

C10

B10

B11

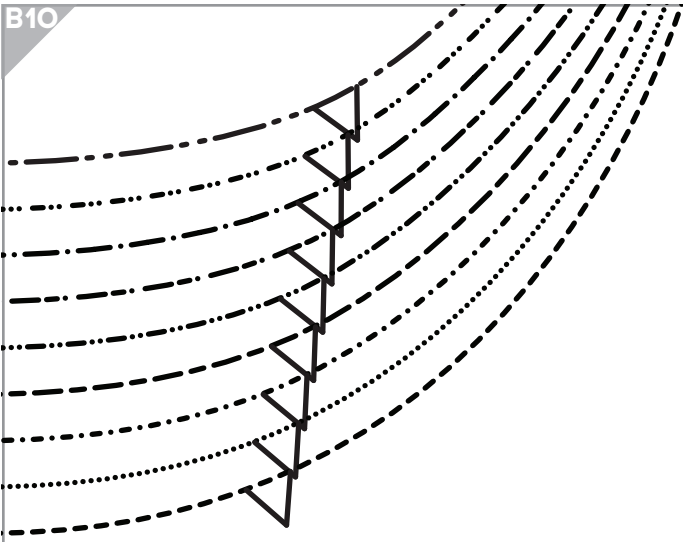

PAGE

35

Society
of CHARM
Rizzo
JACKET
SIZES 18-34

10

Lining Front,
C Cup
Cut 2 lining



WELT POCKET



GRAINLINE

FOLD BACK THIS MARGIN

C10

FOLD BACK THIS MARGIN

C11

PAGE

18 20 22 24 26 28 30 32 34



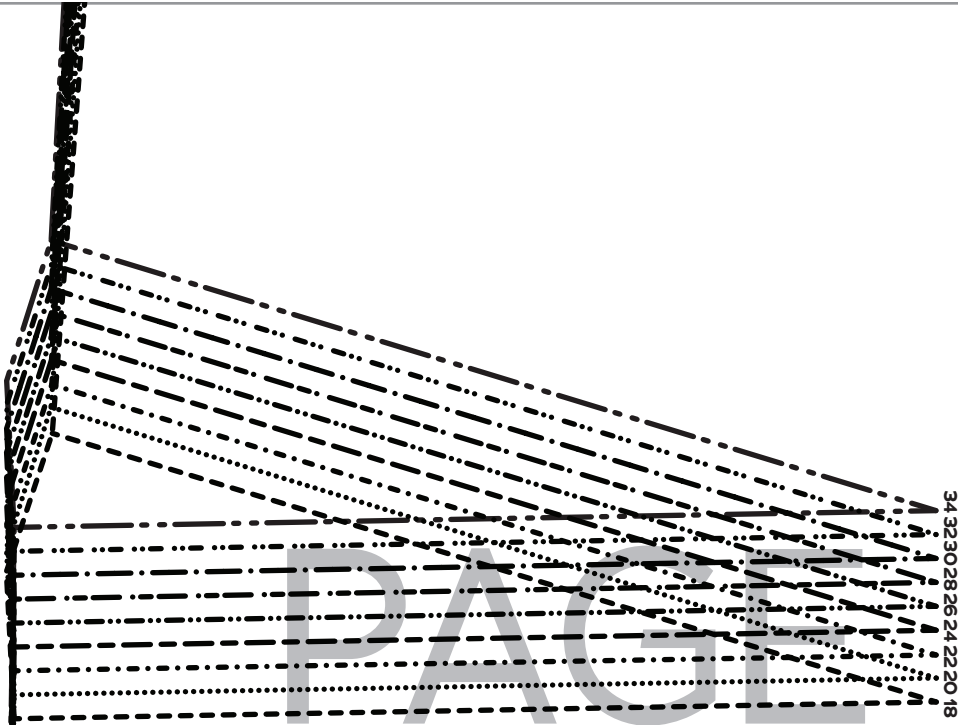

37

C1

C2



PAGE



GRAINLINE

Society of Charm
Rizzo
JACKET
 SIZES 18-34

1

Jacket Front,
C Cup
 Cut 2 fabric

FOLD BACK THIS MARGIN

D1

FOLD BACK THIS MARGIN

D2

C2

18

C3

PAGE

39

FOLD BACK THIS MARGIN

D2

FOLD BACK THIS MARGIN

D3

C3

C4

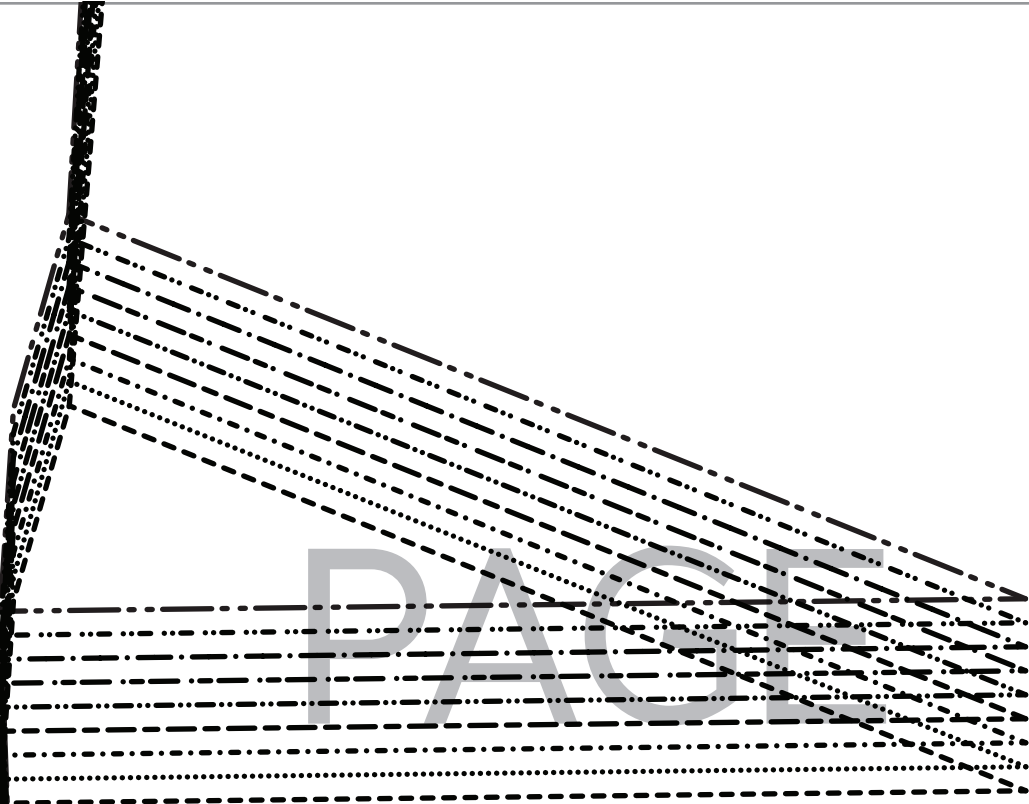

PAPER

34323028262422 2018

40

34323028262422 2018

FOLD BACK THIS MARGIN

D3

D4

FOLD BACK THIS MARGIN

C4

C5



PAGE

41

GRAINLINE

FOLD BACK THIS MARGIN

Society of CHARM
Rizzo
JACKET
SIZES 18-34

1

Jacket Front,
F/G Cup
Cut 2 fabric

D4

FOLD BACK THIS MARGIN

D5

C5

C6

18
20

18
20
22
24
26
28
30
32
34

PAGE

42

FOLD BACK THIS MARGIN

D5

FOLD BACK THIS MARGIN

D6

C6

C7

PAGE 43

FOLD BACK THIS MARGIN



D6

FOLD BACK THIS MARGIN

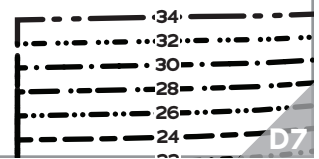

D7

Society
 of CHARM
Rizzo
JACKET
 SIZES 18-34
11
 Lining
 Back
 Cut 1 lining on fold

PAGE
44

FOLD BACK THIS MARGIN

FOLD

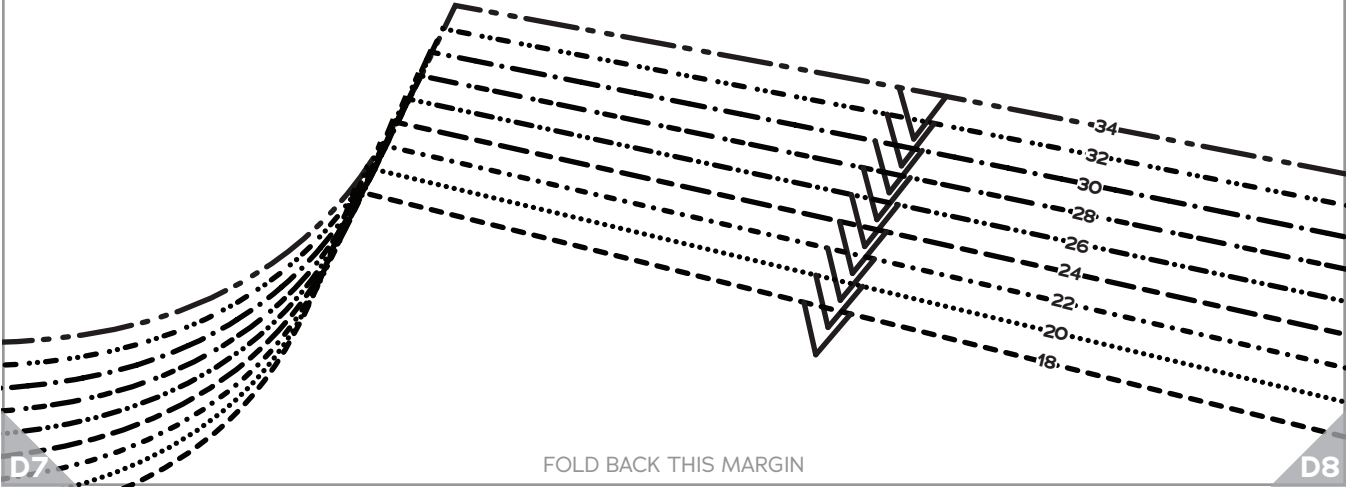

FOLD BACK THIS MARGIN

C8

C9

PAGE

45

FOLD BACK THIS MARGIN



34
32
30
28
26
24
22
20
18

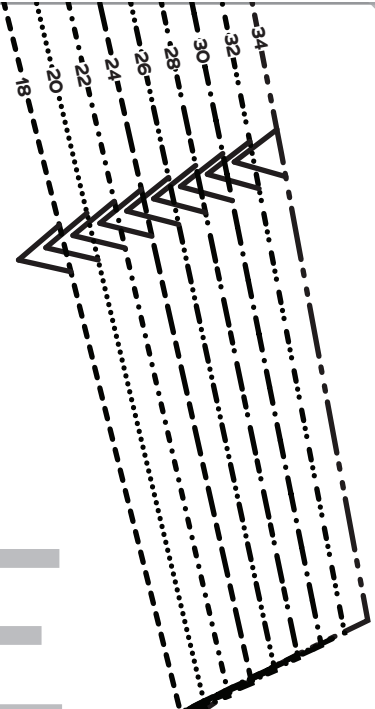

FOLD BACK THIS MARGIN

D8

D9

C9

C10

PAGE

46

FOLD BACK THIS MARGIN

D9

FOLD BACK THIS MARGIN

D10

C10

C11

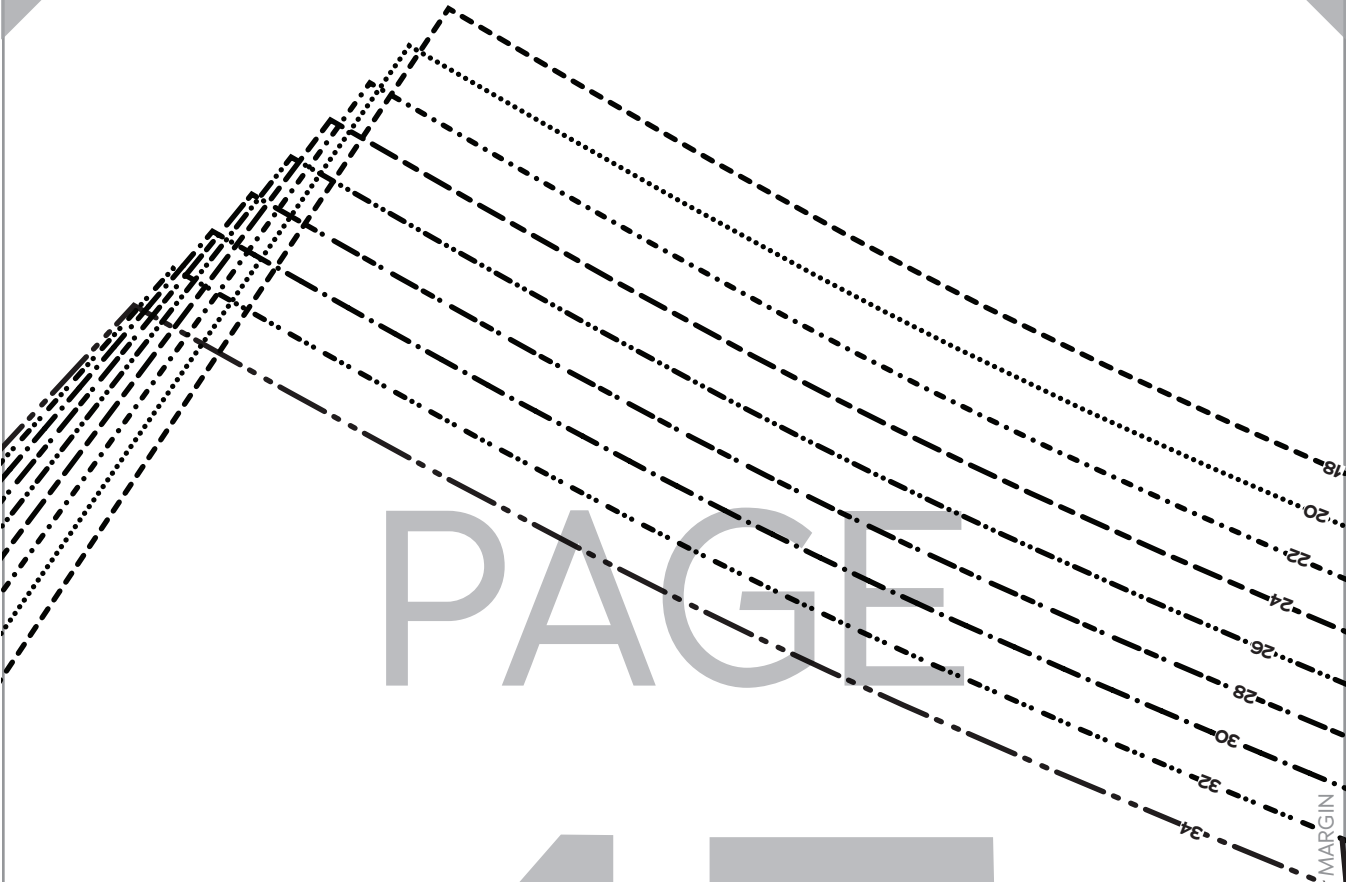

PAGE

47

FOLD BACK THIS MARGIN

D10

FOLD BACK THIS MARGIN

D11

PAGE

48

OVERLAP

UNDERLAP

FOLD BACK THIS MARGIN

34
32
30
28
26
24
22
20
18

PAGE

49

FOLD BACK THIS MARGIN

WELT POCKET

FOLD BACK THIS MARGIN

D1

D2

PAGE

50

FOLD BACK THIS MARGIN

FOLD BACK THIS MARGIN

E1

E2

D2

D3

PAGE

51

FOLD BACK THIS MARGIN

20

18

E2

FOLD BACK THIS MARGIN

E3

D3

D4

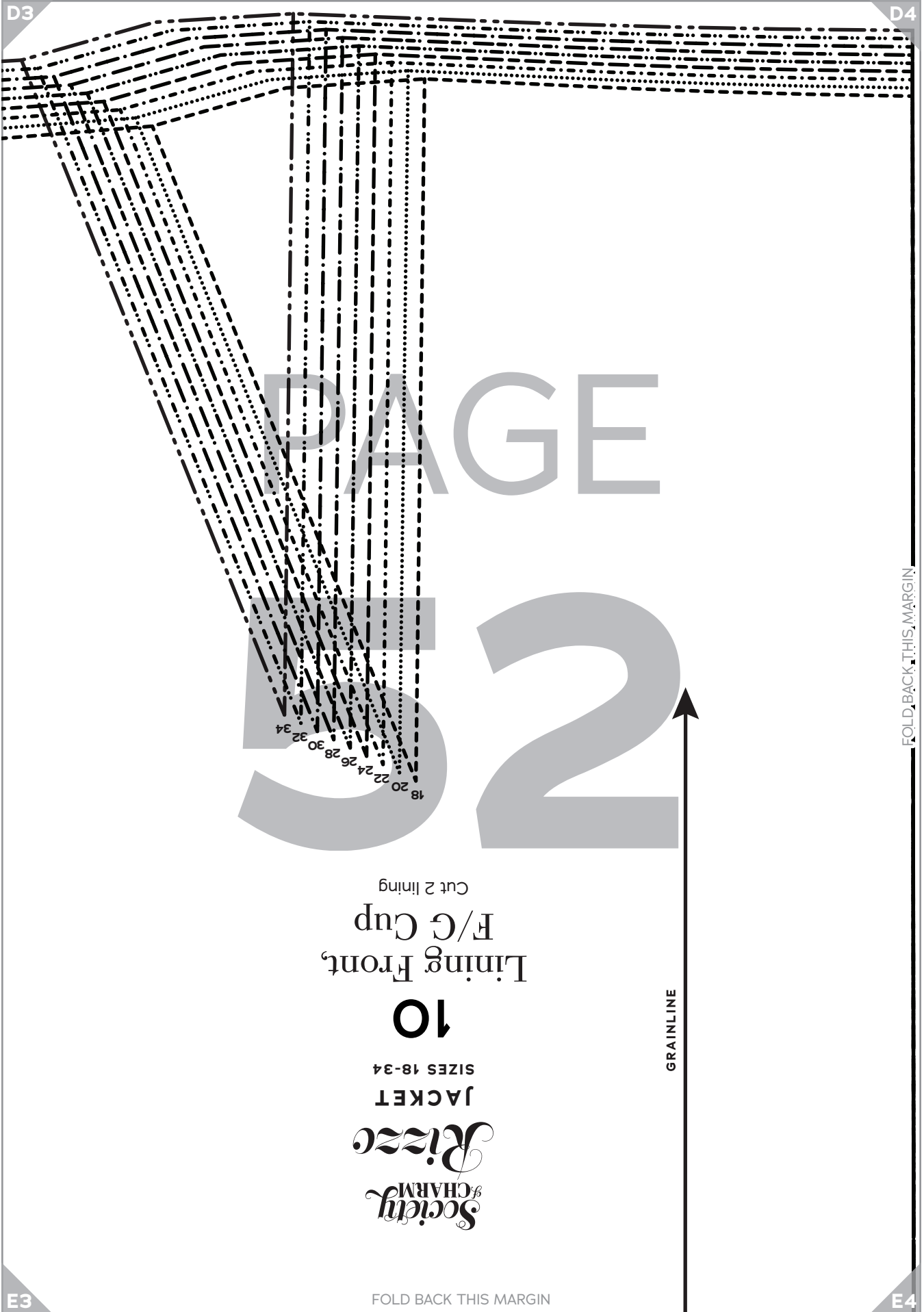

Lining Front,
F/G Cup
Cut 2 lining

10

SIZES 18-34

JACKET

Rizzo
Society
of CHARM

GRAINLINE

FOLD BACK THIS MARGIN

FOLD BACK THIS MARGIN

E3

E4

D4

D5

E4

E5

PAGE

53

WELT POCKET

FOLD BACK THIS MARGIN

FOLD BACK THIS MARGIN

D5

D6

34
32
30
28
26
24
22
20
18

PAGE

54

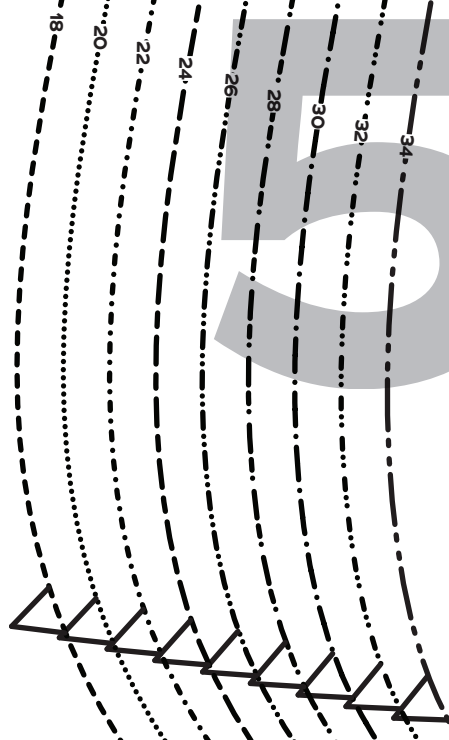

GRAINLINE



FOLD BACK THIS MARGIN

E5

E6

FOLD BACK THIS MARGIN

D6

D7

Society
 & CHARM
Rizzo
 JACKET
 SIZES 18-34

13
 Welt Pocket
 Bag
 Cut 1 lining

PAGE

55

22
 20
 18



FOLD BACK THIS MARGIN

E6

FOLD BACK THIS MARGIN

E7

D7

D8

Society
of CHARM

Rizzo

JACKET
SIZES 18-34

PAGE

3

Yoke

Cut 1 fabric on fold

56



FOLD BACK THIS MARGIN

E7

FOLD BACK THIS MARGIN

E8

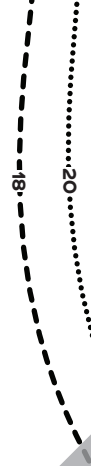

18

20

D8

D9

PAGE
57

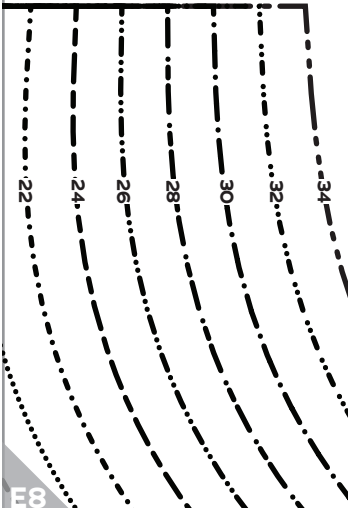

E8

FOLD BACK THIS MARGIN

E9

FOLD BACK THIS MARGIN

D9

D10

PAGE

58

FOLD BACK THIS MARGIN

E9

FOLD BACK THIS MARGIN

E10

D10

D11

PAGE

Sleeve
Cut 2 fabric, 2 lining

6

SIZES 18-34
JACKET
Rizzo
Society of CHARM

GRAINLINE

FOLD BACK THIS MARGIN

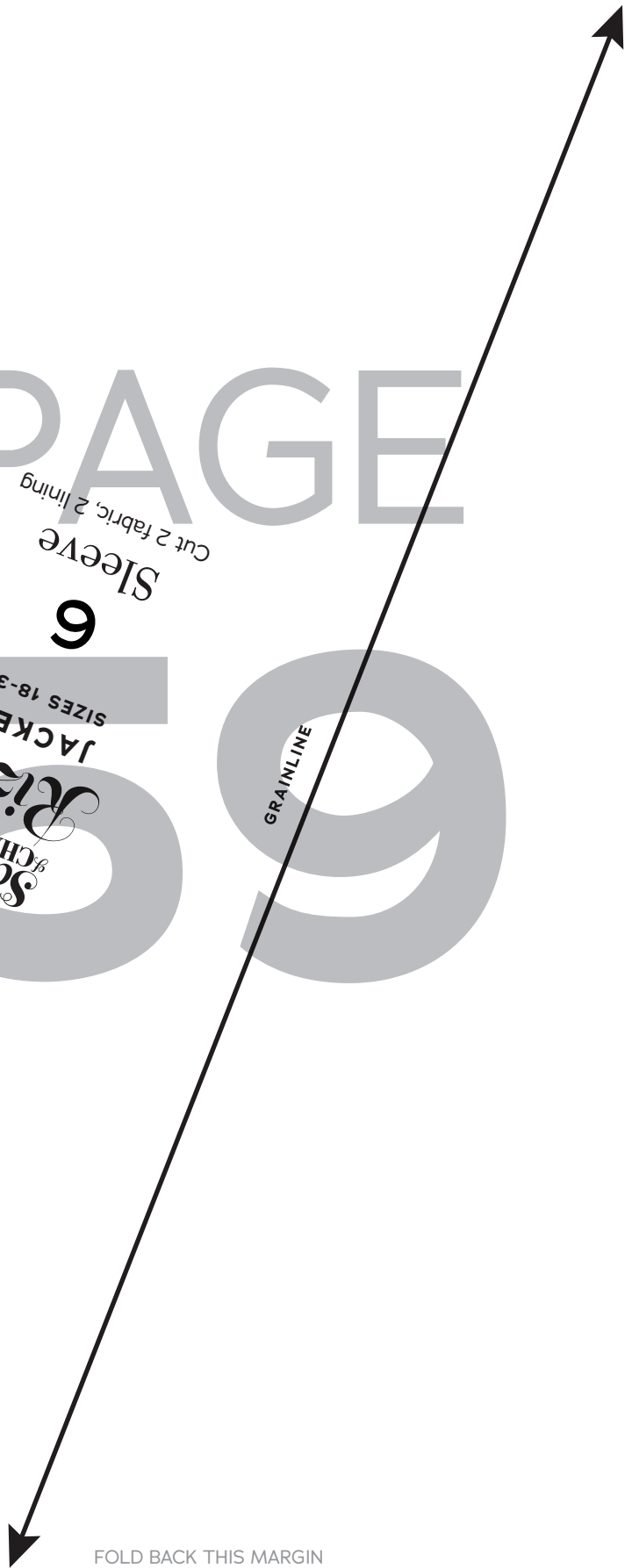

E10

FOLD BACK THIS MARGIN

E11

PAGE 60



Society
of CHARM
Rizzo

JACKET
SIZES 18-34

10

Lining Front,
D/DD Cup

Cut 2 lining

GRAINLINE

PAGE

6

FOLD BACK THIS MARGIN

18 20 22 24 26 28 30 32 34

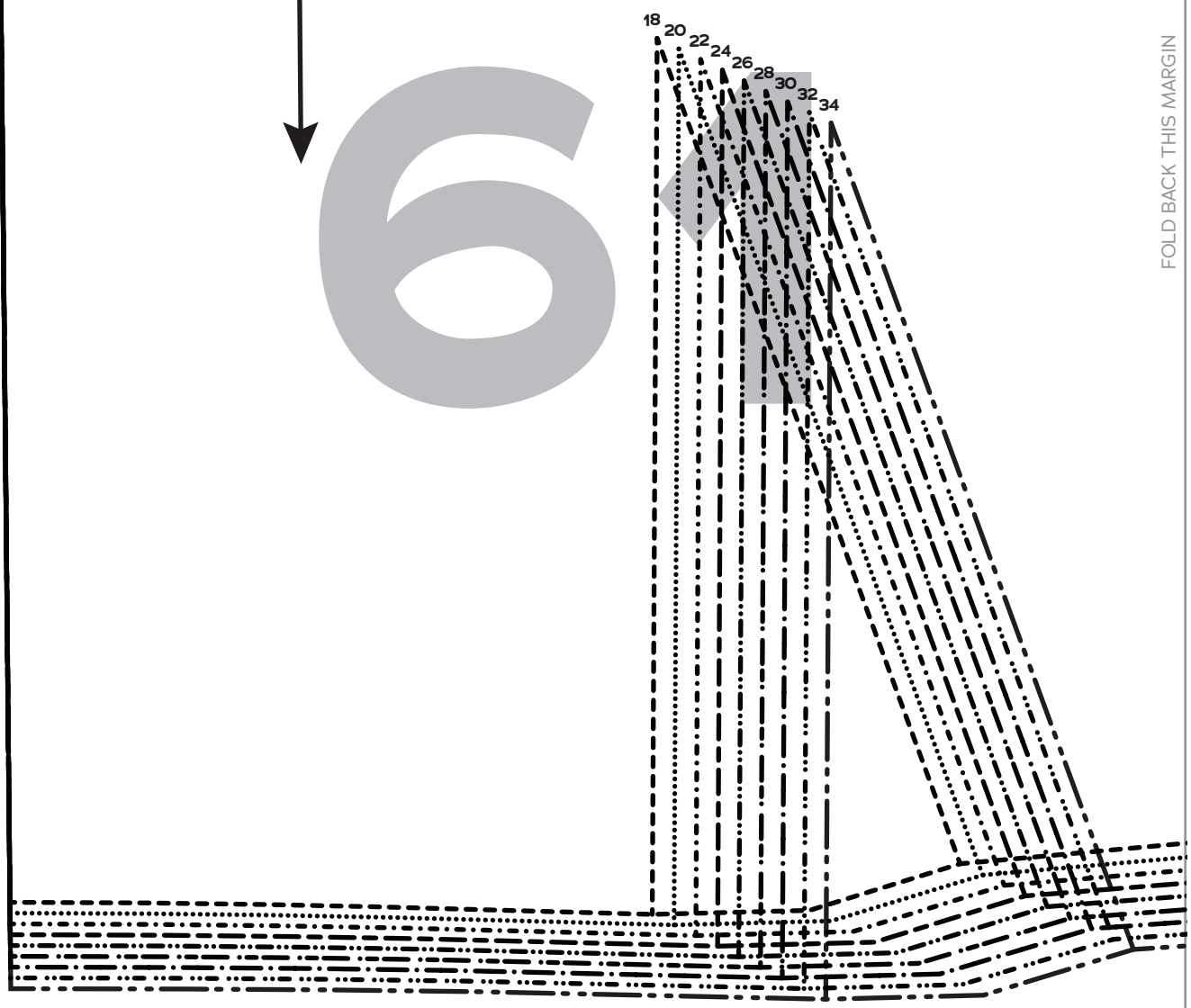

E1

E2

PAGE 62

18

FOLD BACK THIS MARGIN

PAGE

63

FOLD BACK THIS MARGIN

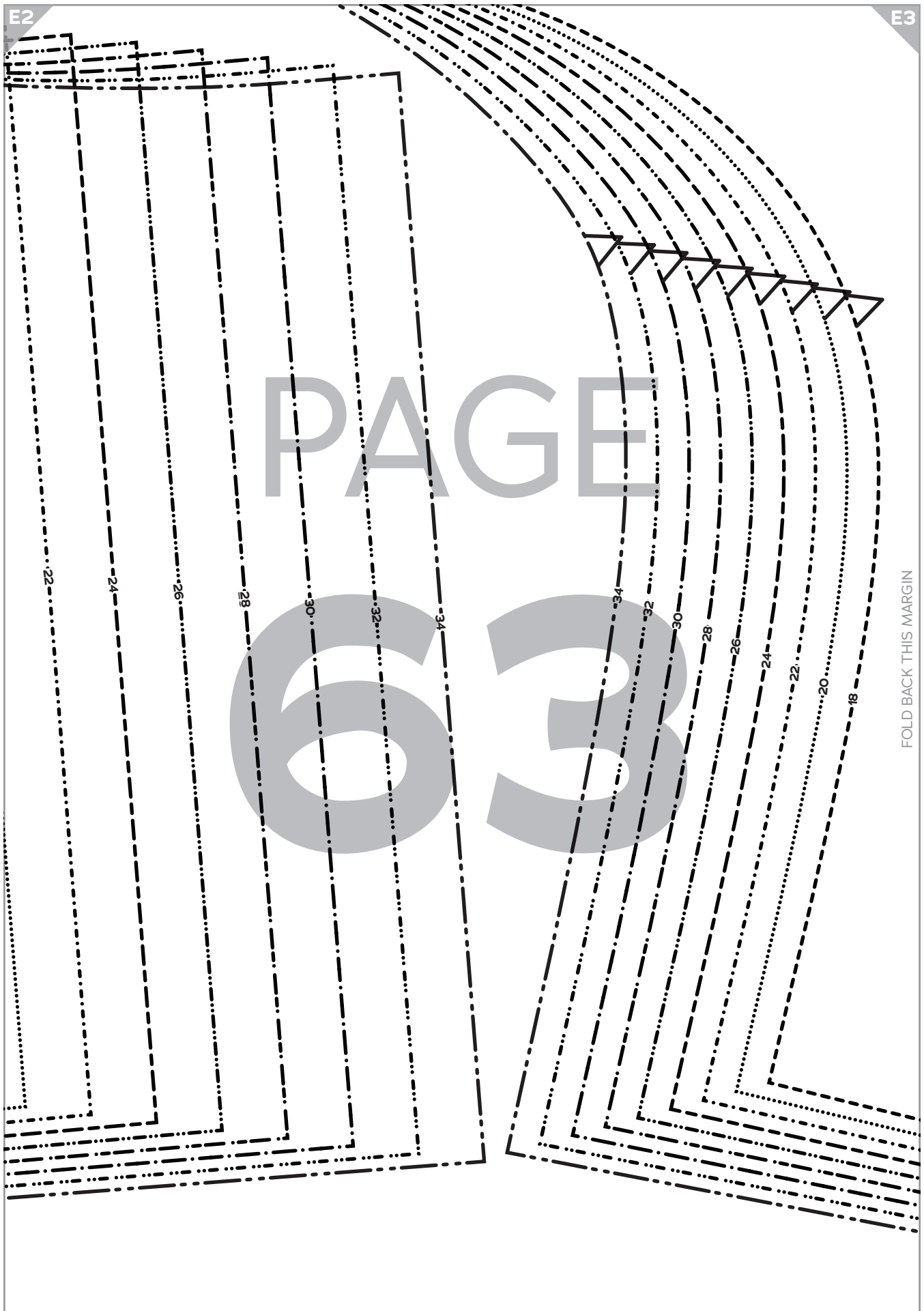

E3

E4

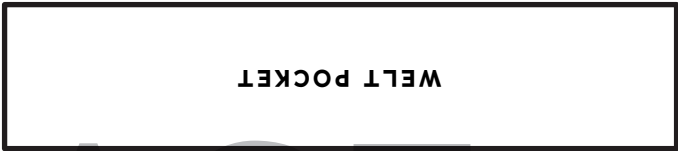

WELT POCKET

PAGE

64



FOLD BACK THIS MARGIN

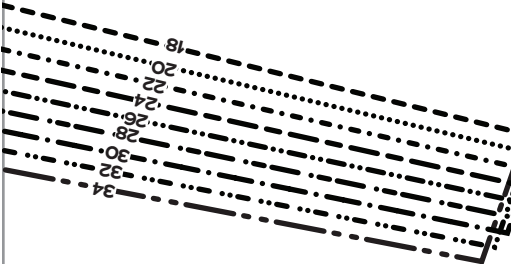

Society
of CHARM
Rizzo

JACKET
SIZES 18-34

10

Lining Front,
H Cup

Cut 2 lining

GRAINLINE

PAGE

65

18
20
22
24
26
28
30
32
34

FOLD BACK THIS MARGIN

PAGE 66

FOLD BACK THIS MARGIN

E6

E7

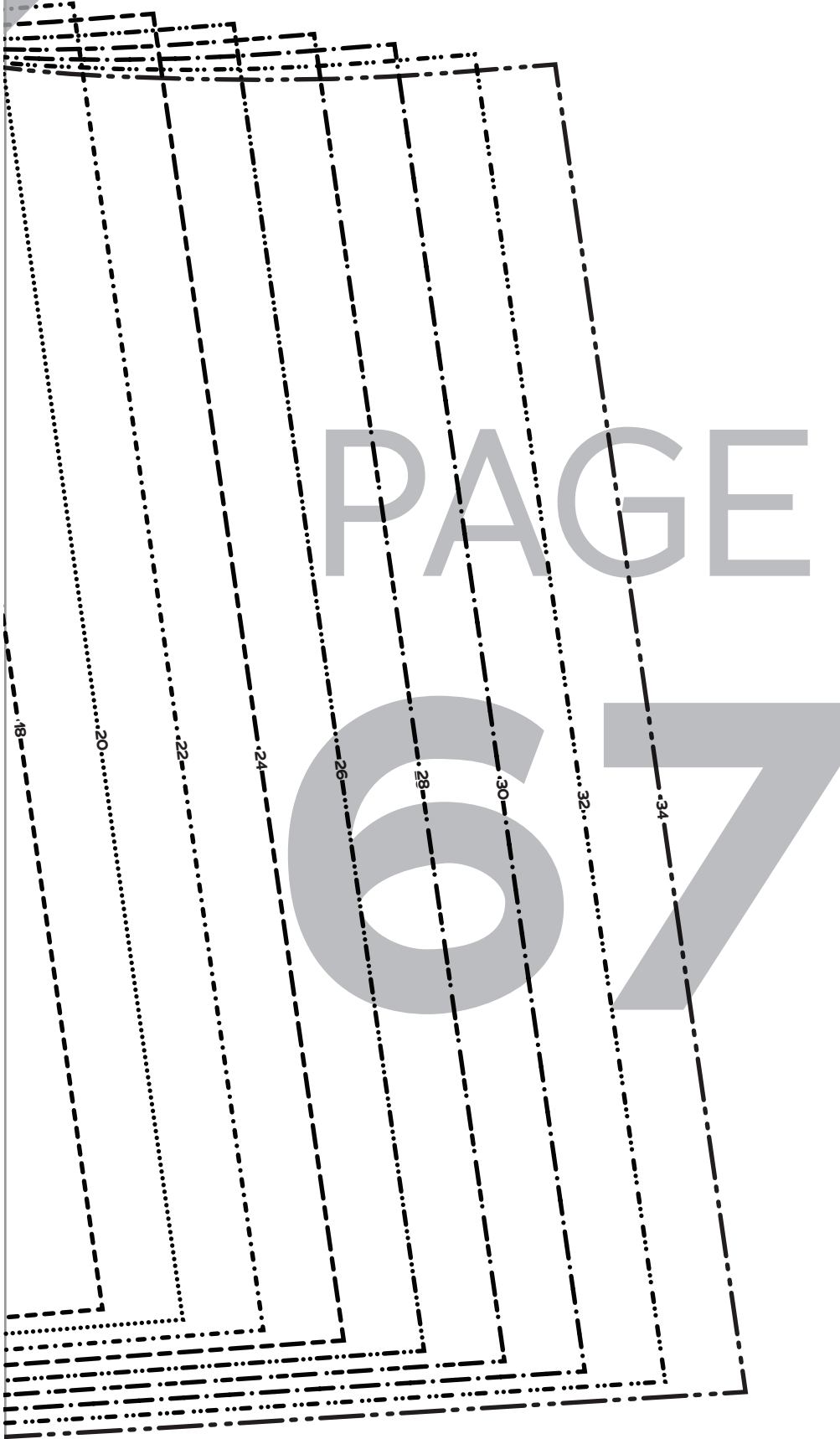

FOLD



FOLD BACK THIS MARGIN

Society
of CHARM
Rizzo

JACKET
SIZES 18-34
PAGE

2

Jacket
Back

Cut 1 fabric on fold

68

FOLD BACK THIS MARGIN

PAGE

69

FOLD BACK THIS MARGIN

18

20

22

24

26

28

30

32

34



PAGE
70



FOLD BACK THIS MARGIN

Society of CHARM *Rizzo*
JACKET
 SIZES 18-34

14
 Welt Pocket Interfacing
 Cut 1 interfacing

PAGE

71

FOLD BACK THIS MARGIN

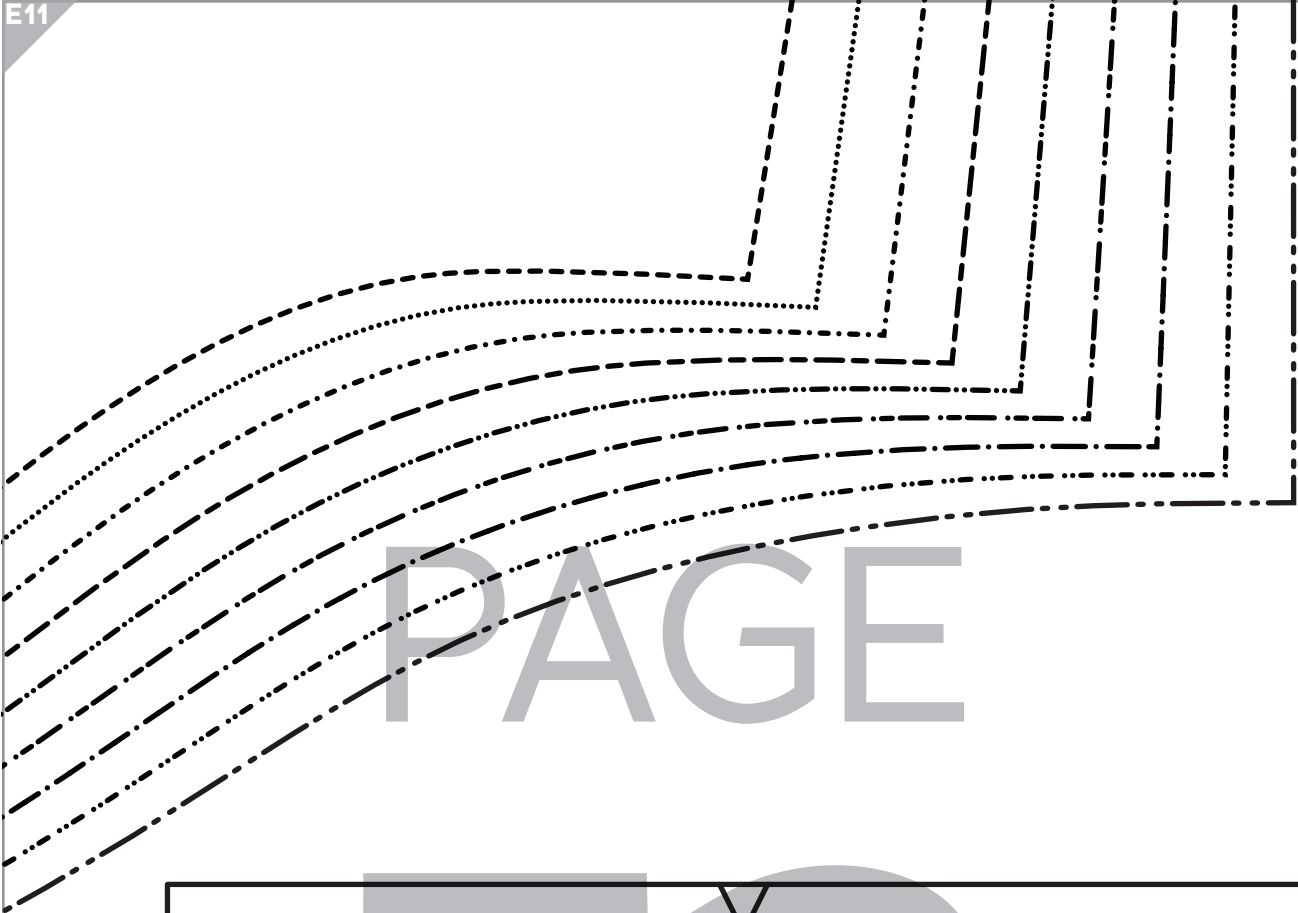

PAGE

72

GRAINLINE



Society
of CHARM
Rizzo
JACKET
SIZES 18-34

12
Welt Pocket
Cut 1 lining, 1 interfacing