

GRAINLINE



Society of CHARM
Barbara

BODICE
SIZES 2-20

4
Bodice Center Back,
Thin Strap
Cut 2 fabric, 2 lining

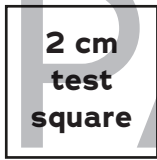
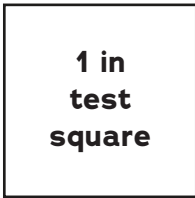

PAGE

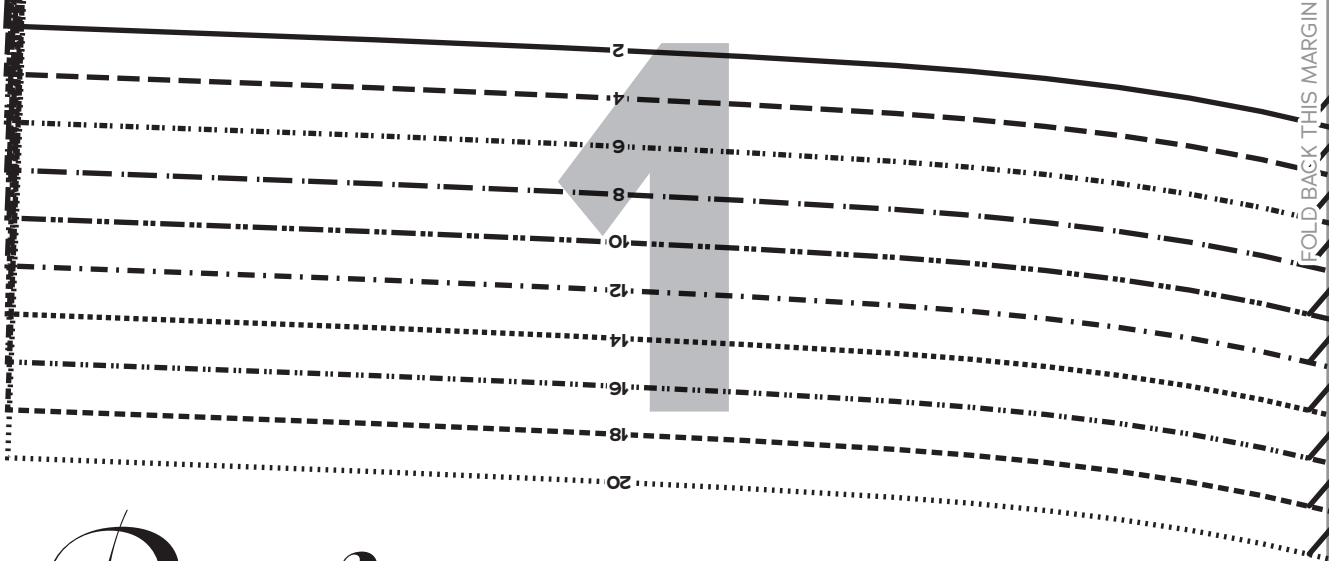

Barbara

BODICE

Sizes 2-20
with cup sizes A-H

5/8 inch (in) (1.5 cm) seam allowances are included on all pattern pieces.

SIZES 2-20
PATTERN
SIZE KEY

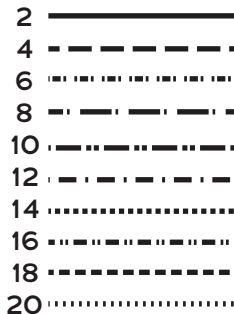

SYMBOL KEY

grainline arrow



match point/
placement mark



© 2023 Charm Patterns
by Gertie. Distribution
and Commercial Use
Prohibited.

A1

PAGE

2

FOLD BACK THIS MARGIN

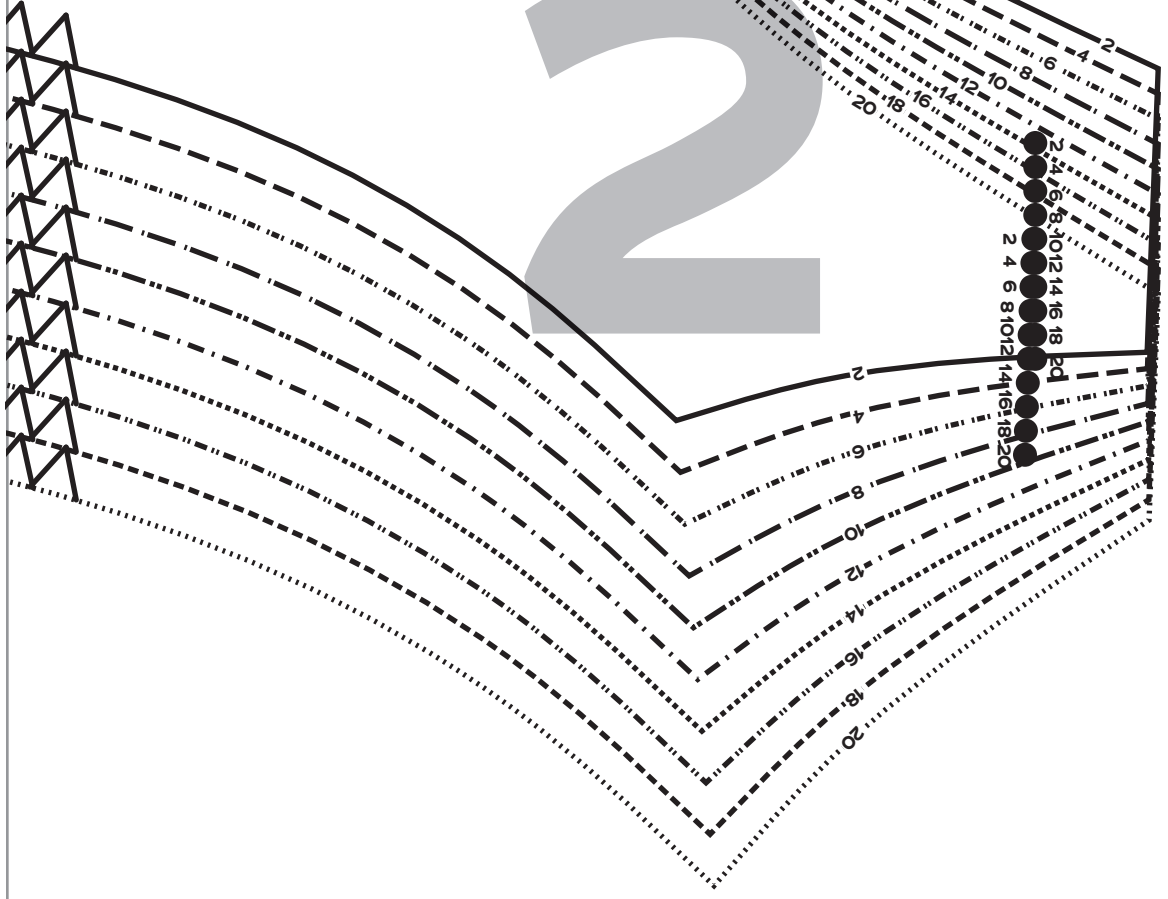
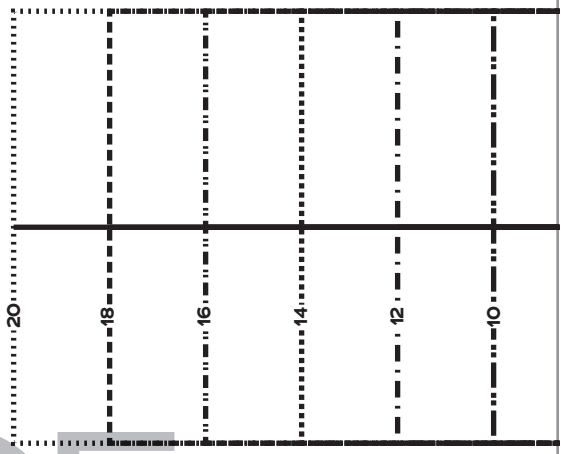

A1

FOLD BACK THIS MARGIN

A2

Society
of CHARM

Barbara

BODICE

SIZES 2-20

8
6
4
2

PAGE

3

FOLD BACK THIS MARGIN

A2

FOLD BACK THIS MARGIN

A3

FOLD LINE

7

Thin Tie Strap

Cut 4 fabric, 4 interfacing

GRAINLINE

PAGE

FOLD BACK THIS MARGIN

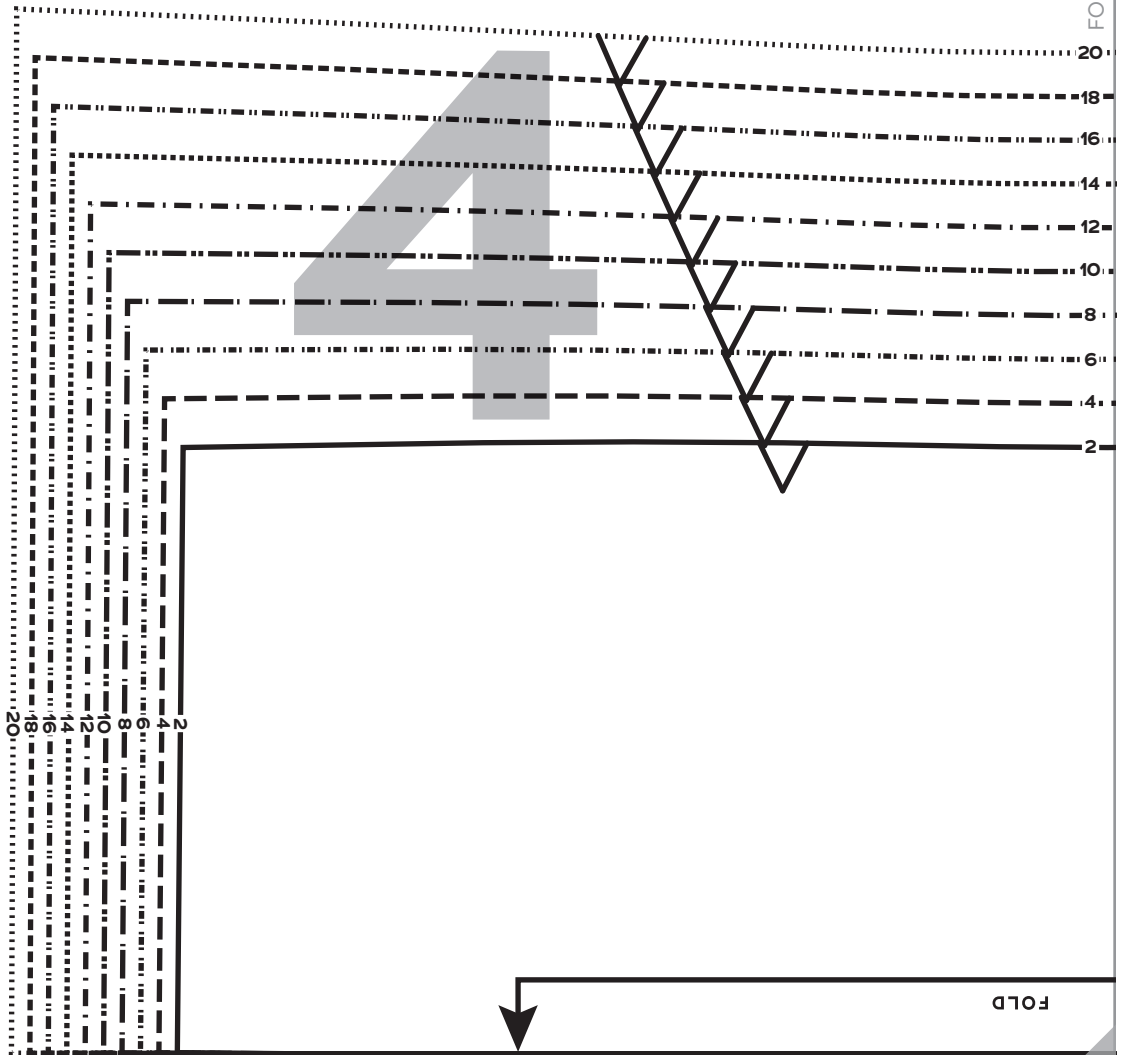

A3

FOLD BACK THIS MARGIN

A4

PAGE

5

FOLD BACK THIS MARGIN

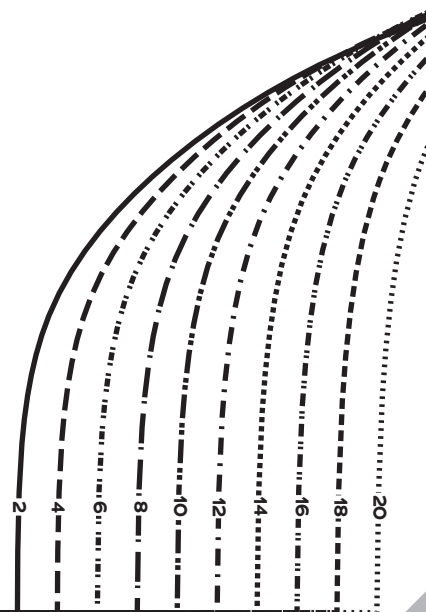

Society
of CHARM

Barbara

BODICE

SIZES 2-20

1

Bodice Center Front,
Thin Strap,
A Cup

Cut 1 fabric on fold, 1 lining on fold



A4

FOLD BACK THIS MARGIN

A5

PAGE 6

FOLD BACK THIS MARGIN

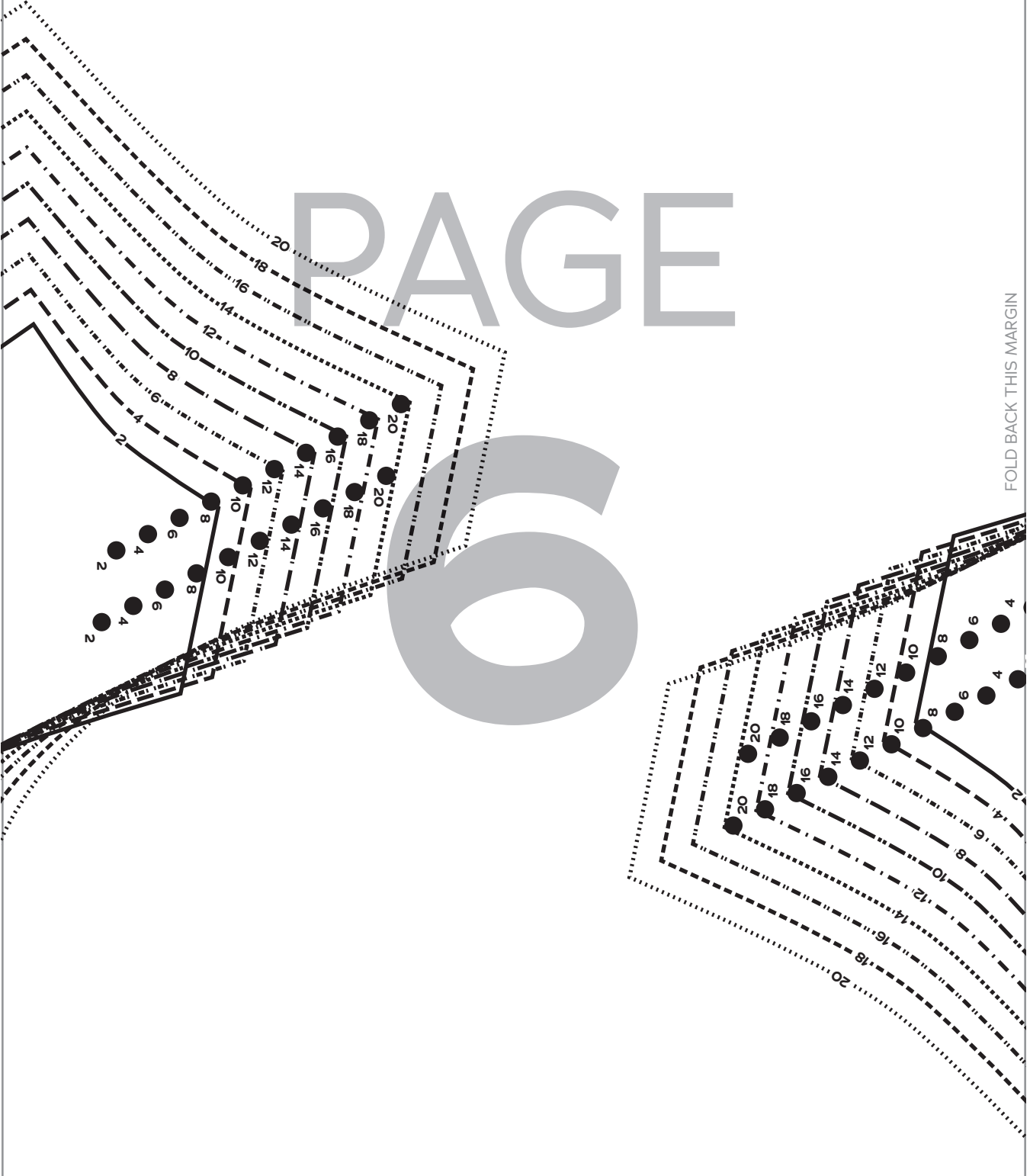

A5

FOLD BACK THIS MARGIN

A6

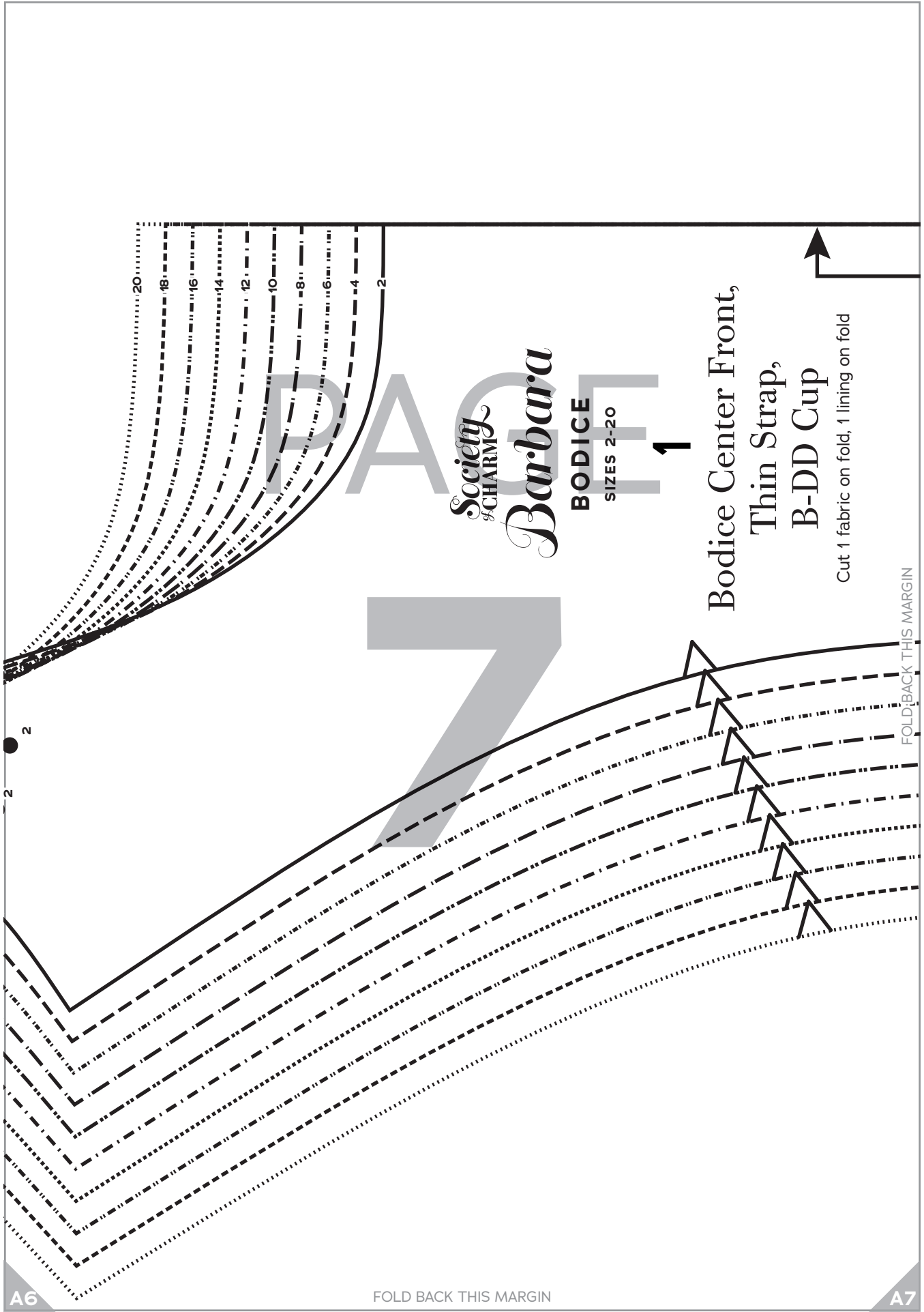

Society of CHARM
Barbara

BODICE
SIZES 2-20

1

Bodice Center Front,
Thin Strap,
B-DD Cup

Cut 1 fabric on fold, 1 lining on fold

2

A6

FOLD BACK THIS MARGIN

FOLD BACK THIS MARGIN

A7

FOLD

PAGE

FOLD BACK THIS MARGIN

FOLD BACK THIS MARGIN

2
4
6
8
10
12
14
16
18
20

2
4
6
8
10
12
14
16
18
20

A7

FOLD BACK THIS MARGIN

A8

PAGE

9

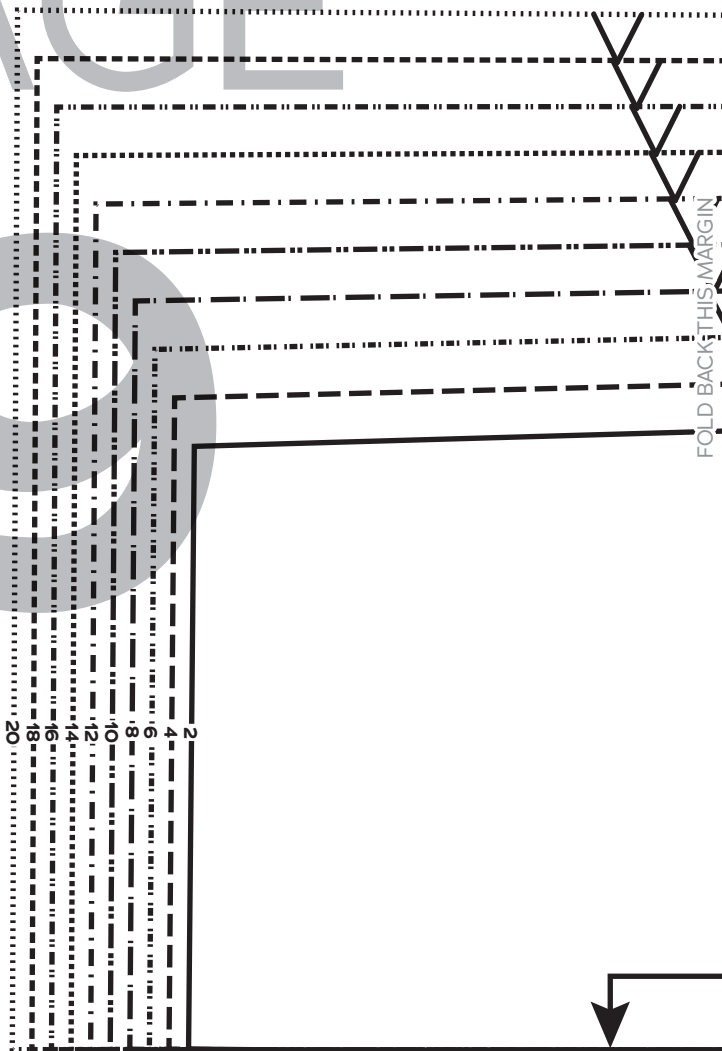

A8

FOLD BACK THIS MARGIN

A9

PAGE

10

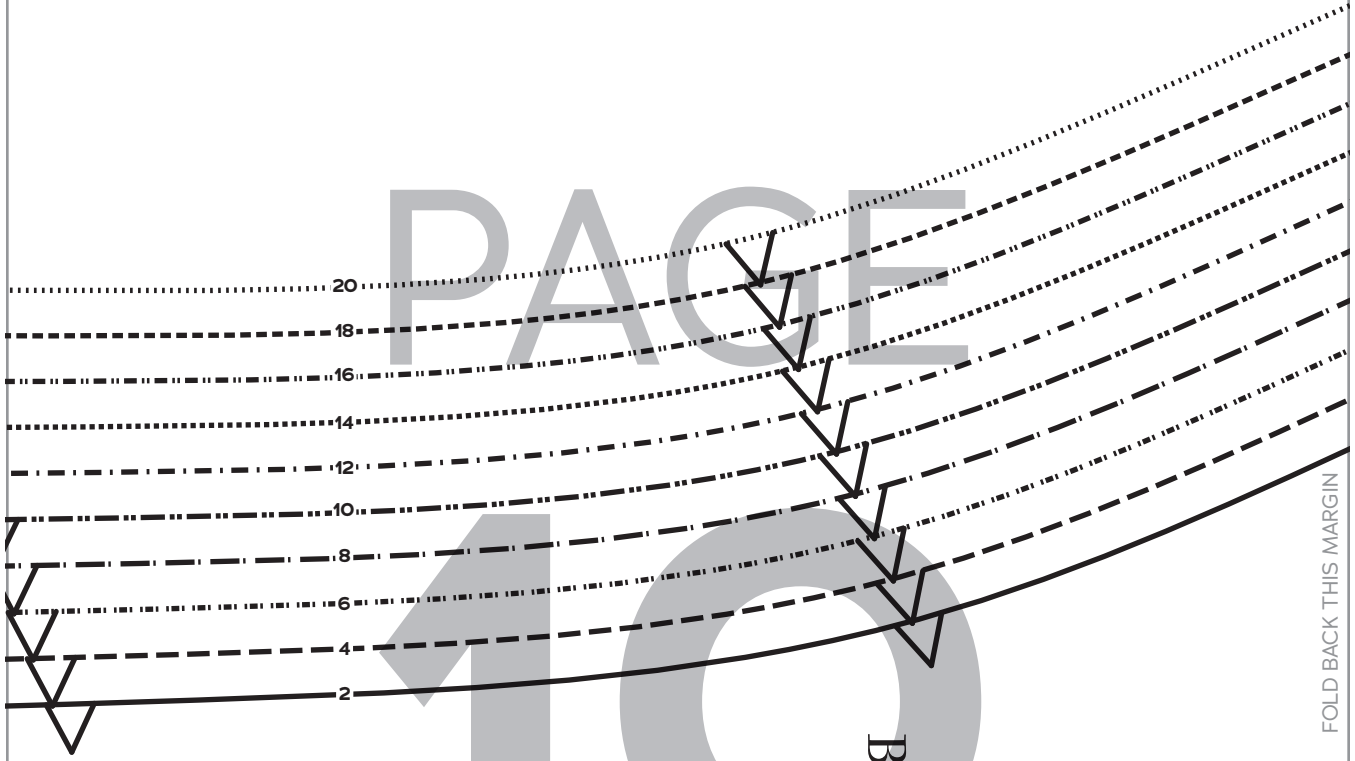

Society
of CHARM
Barbara
BODICE
SIZES 2-20

1

Bodice Center Front,
Thin Strap,
F-H Cup

Cut 1 fabric on fold, 1 lining on fold

FOLD

FOLD BACK THIS MARGIN

A9

FOLD BACK THIS MARGIN

A10

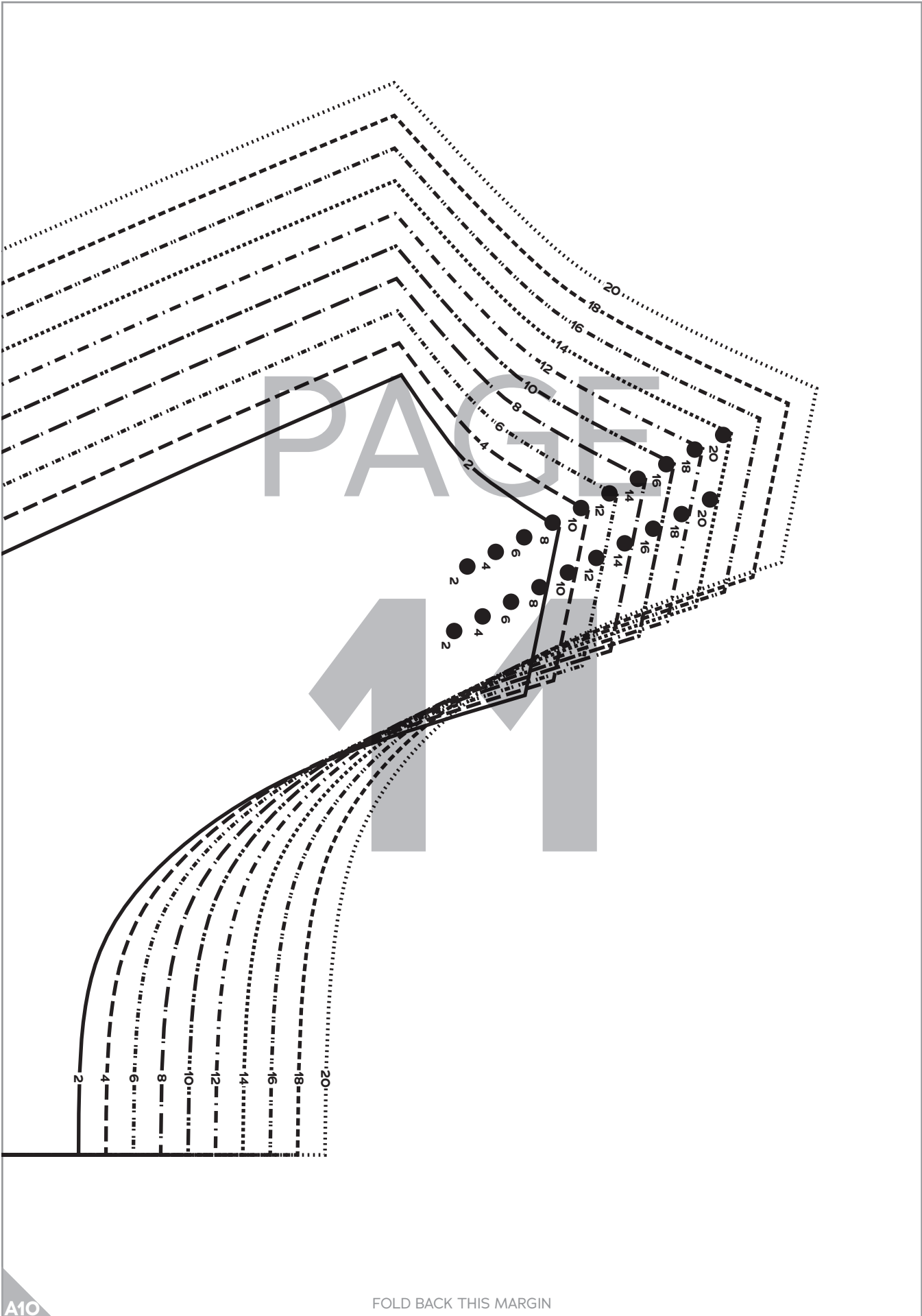

A10

FOLD BACK THIS MARGIN

GRAINLINE

Society of Charm
Barbara
BODICE
SIZES 2-20

6
Bodice Side

Back
Cut 2 fabric, 2 lining

PAGE

12

FOLD BACK THIS MARGIN

2
4
6
8
10
12
14
16
18
20

FOLD BACK THIS MARGIN

A1

A2

PAGE 13

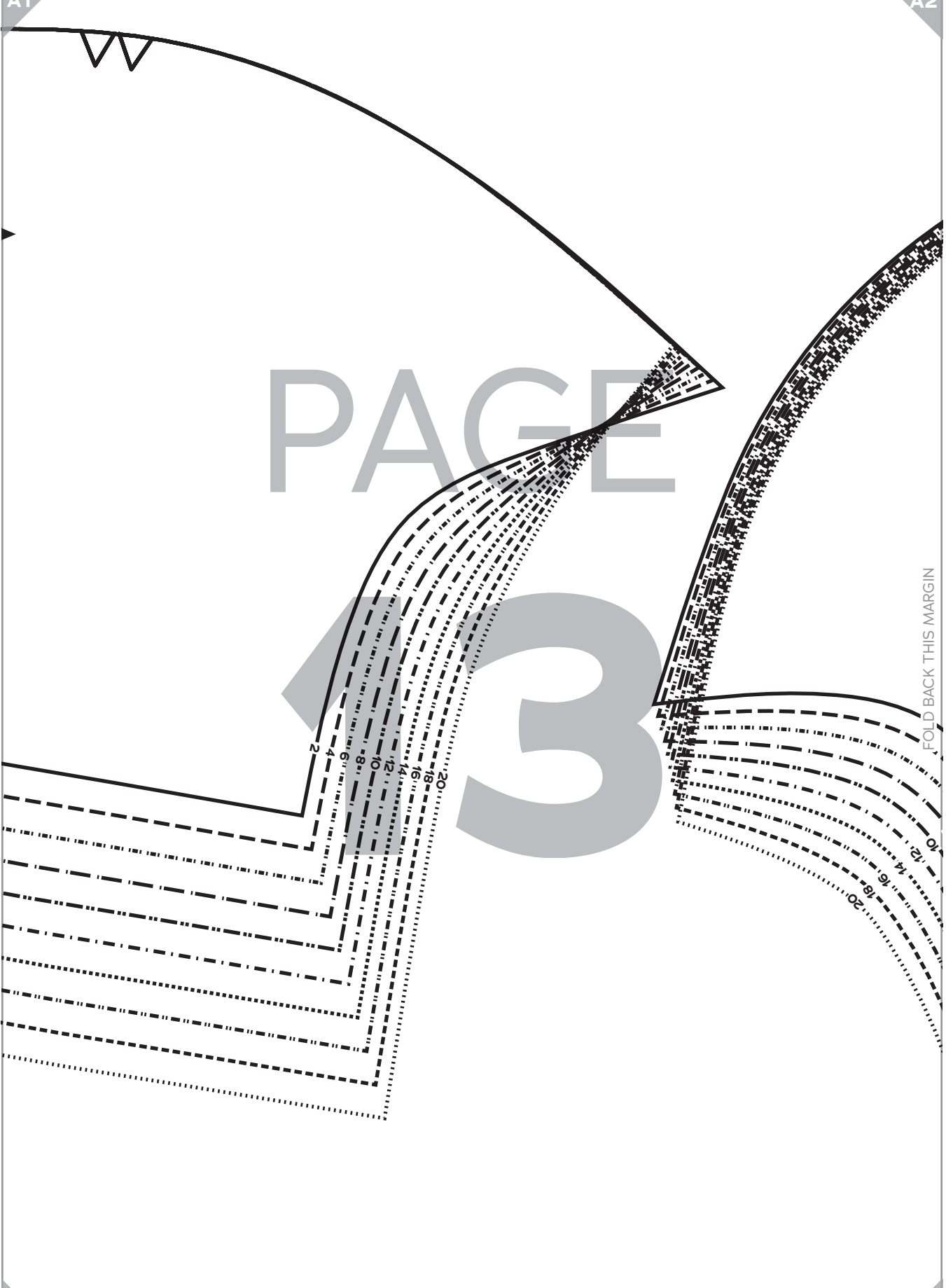

FOLD BACK THIS MARGIN

FOLD BACK THIS MARGIN

B1

B2

A2

A3

PAGE 3

Society of CHARM
Barbara

BODICE
SIZES 2-20

Bodice Side Front,

A Cup

Cut 2 fabric, 2 lining

14

GRAINLINE

FOLD BACK THIS MARGIN

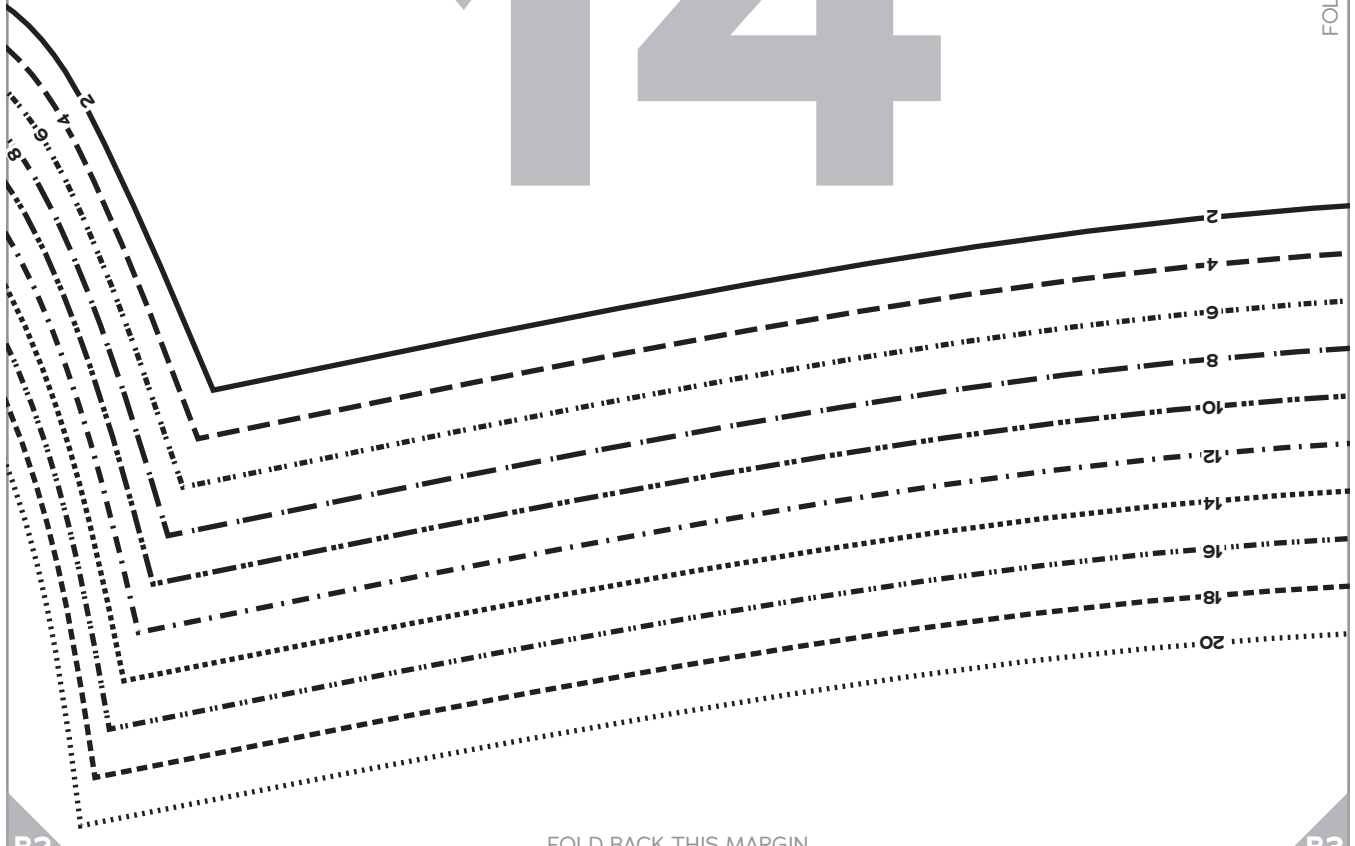

B2

FOLD BACK THIS MARGIN

B3

A3

A4

PAGE

15

FOLD BACK THIS MARGIN

20
18
16
14
12
10
8
6
4
2

B3

FOLD BACK THIS MARGIN

B4

A4

A5

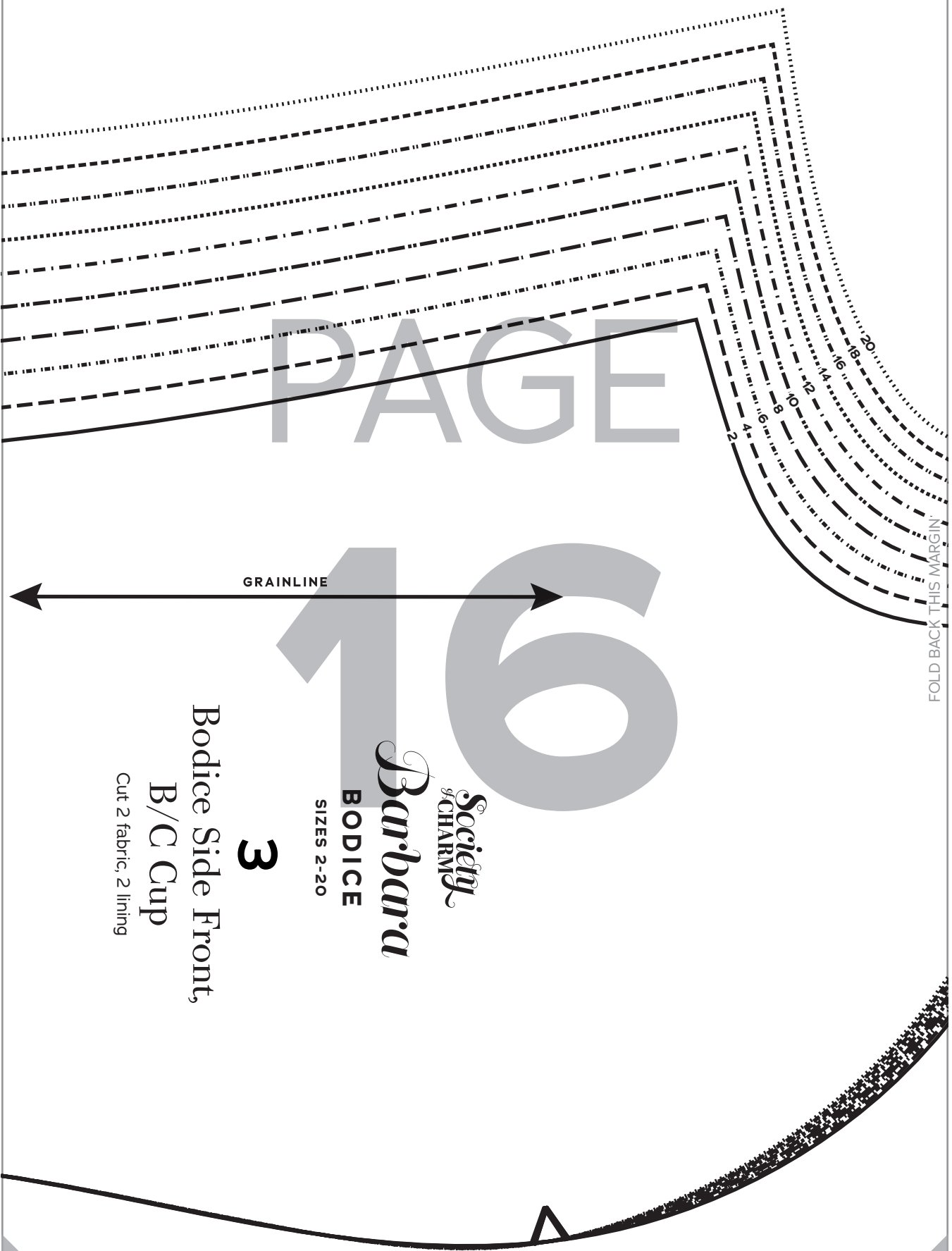

PAGE

16

GRAINLINE

FOLD BACK THIS MARGIN

Society
of CHARM

Barbara

BODICE

SIZES 2-20

3

Bodice Side Front,

B/C Cup

Cut 2 fabric, 2 lining

B4

FOLD BACK THIS MARGIN

B5

A5

A6

PAGE

17

FOLD BACK THIS MARGIN

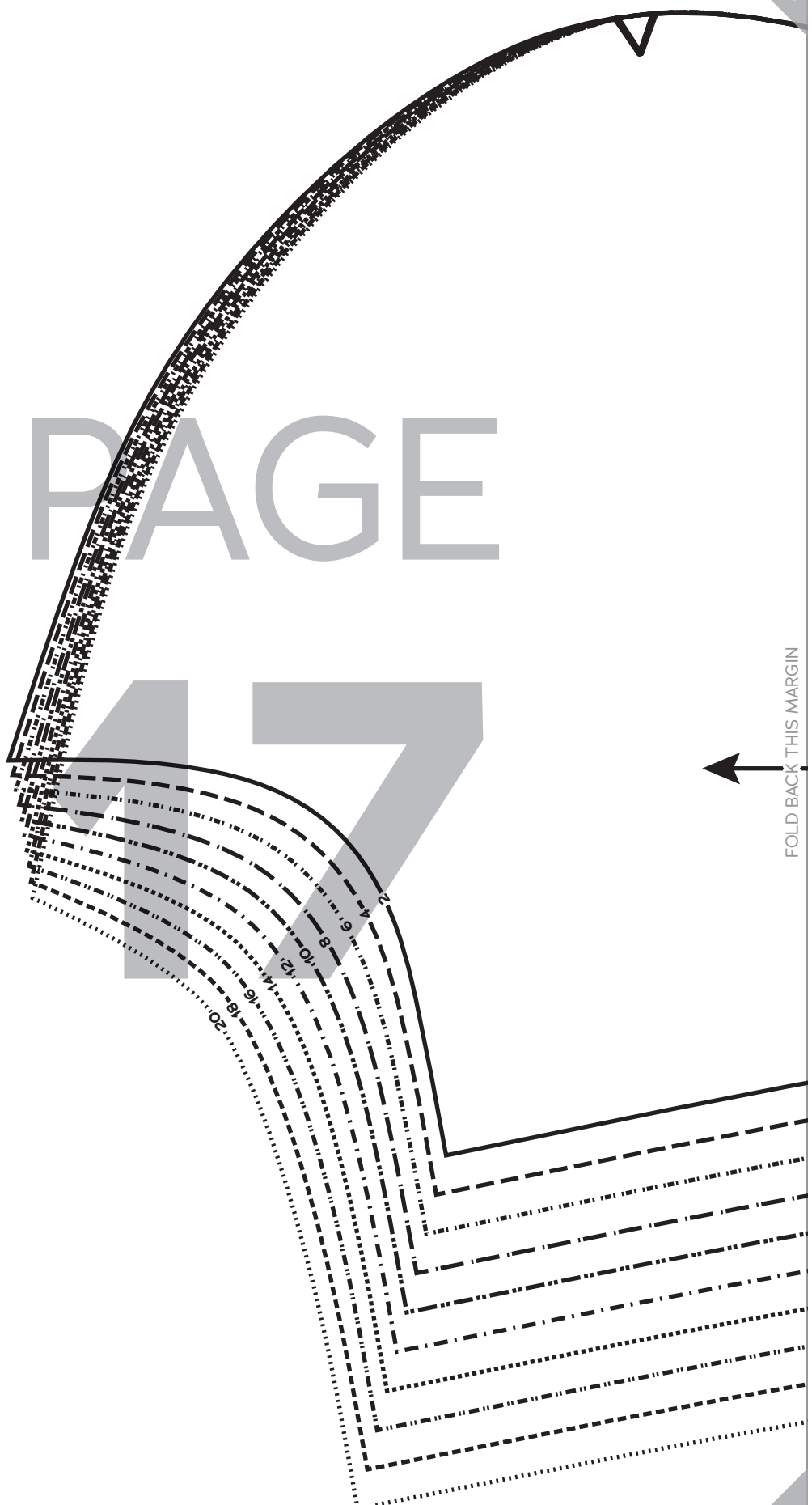
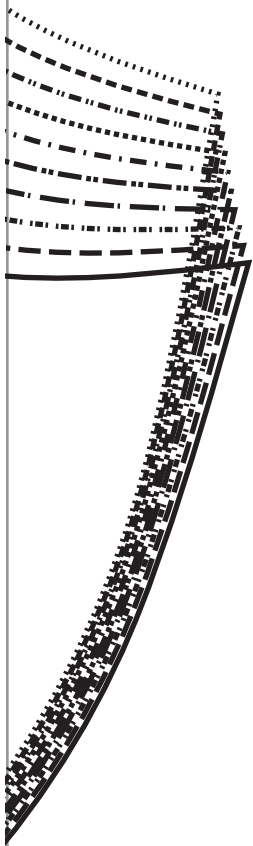

B5

FOLD BACK THIS MARGIN

B6

A6

A7

*Society
of
CHARM*
Barbara

BODICE
SIZES 2-20

3

Bodice Side Front,

D/DD Cup

Cut 2 fabric, 2 lining

P
A
G
E

1
8

GRAINLINE

FOLD BACK THIS MARGIN

B6

FOLD BACK THIS MARGIN

B7

A7

A8

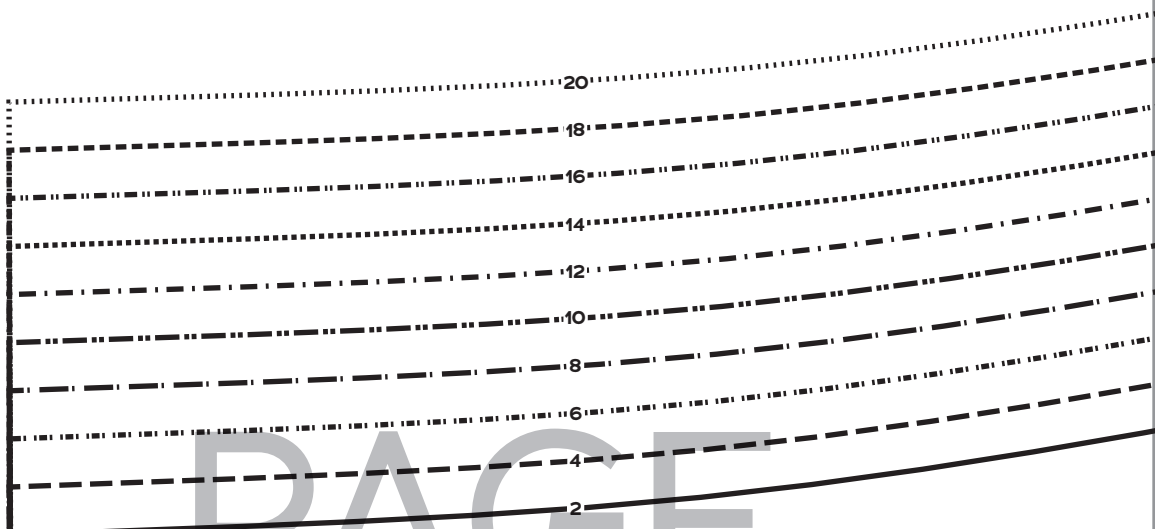

PAGE

19

GRAINLINE

FOLD BACK THIS MARGIN

3

Bodice Side Front,
F/G Cup
Cut 2 fabric, 2 lining

Society
of CHARM
Barbara
BODICE
SIZES 2-20

FOLD BACK THIS MARGIN

B7

B8

A8

A9

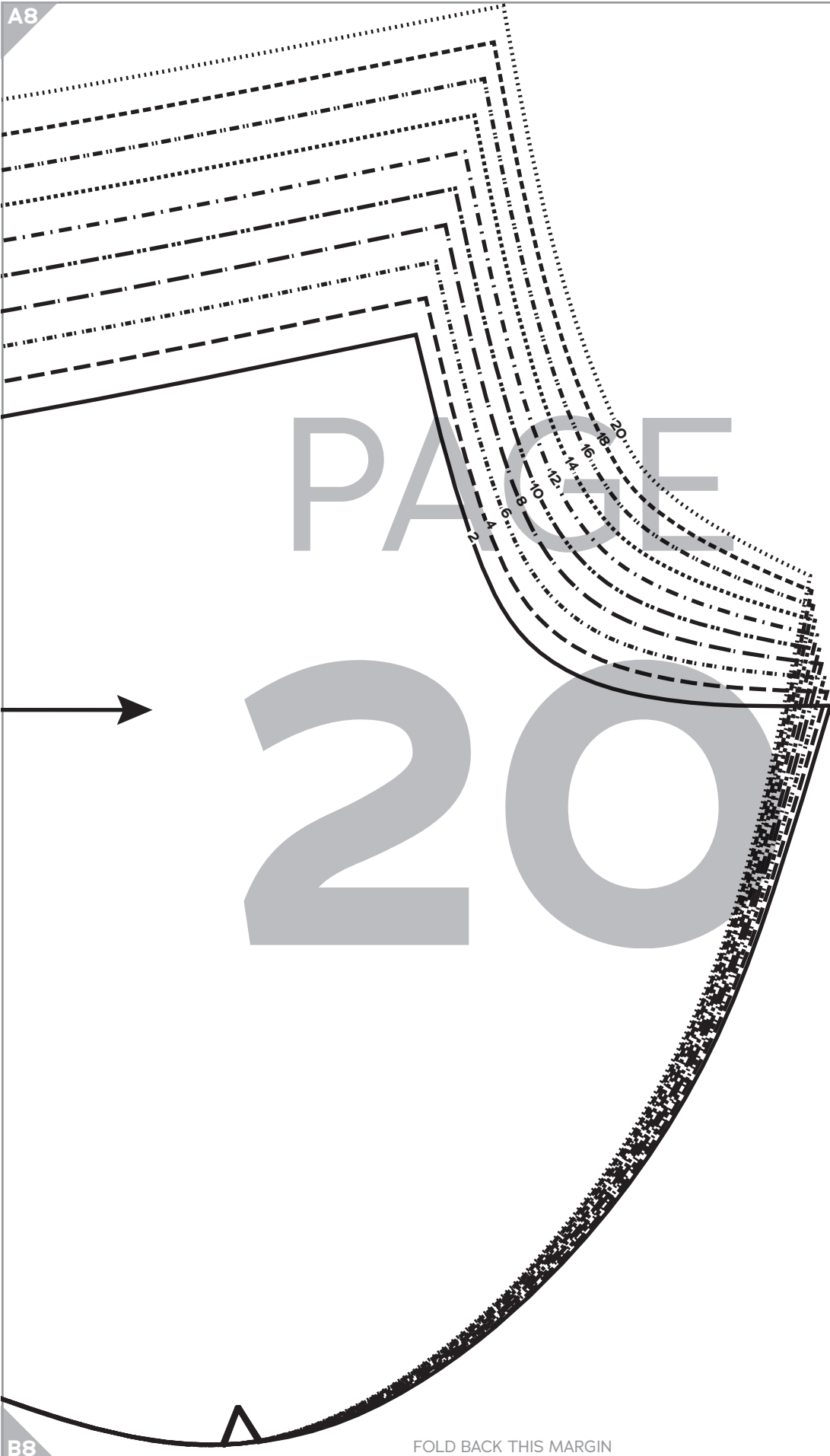

PAGE

20

FOLD BACK THIS MARGIN

B8

FOLD BACK THIS MARGIN

B9

A9

A10

PAGE

21

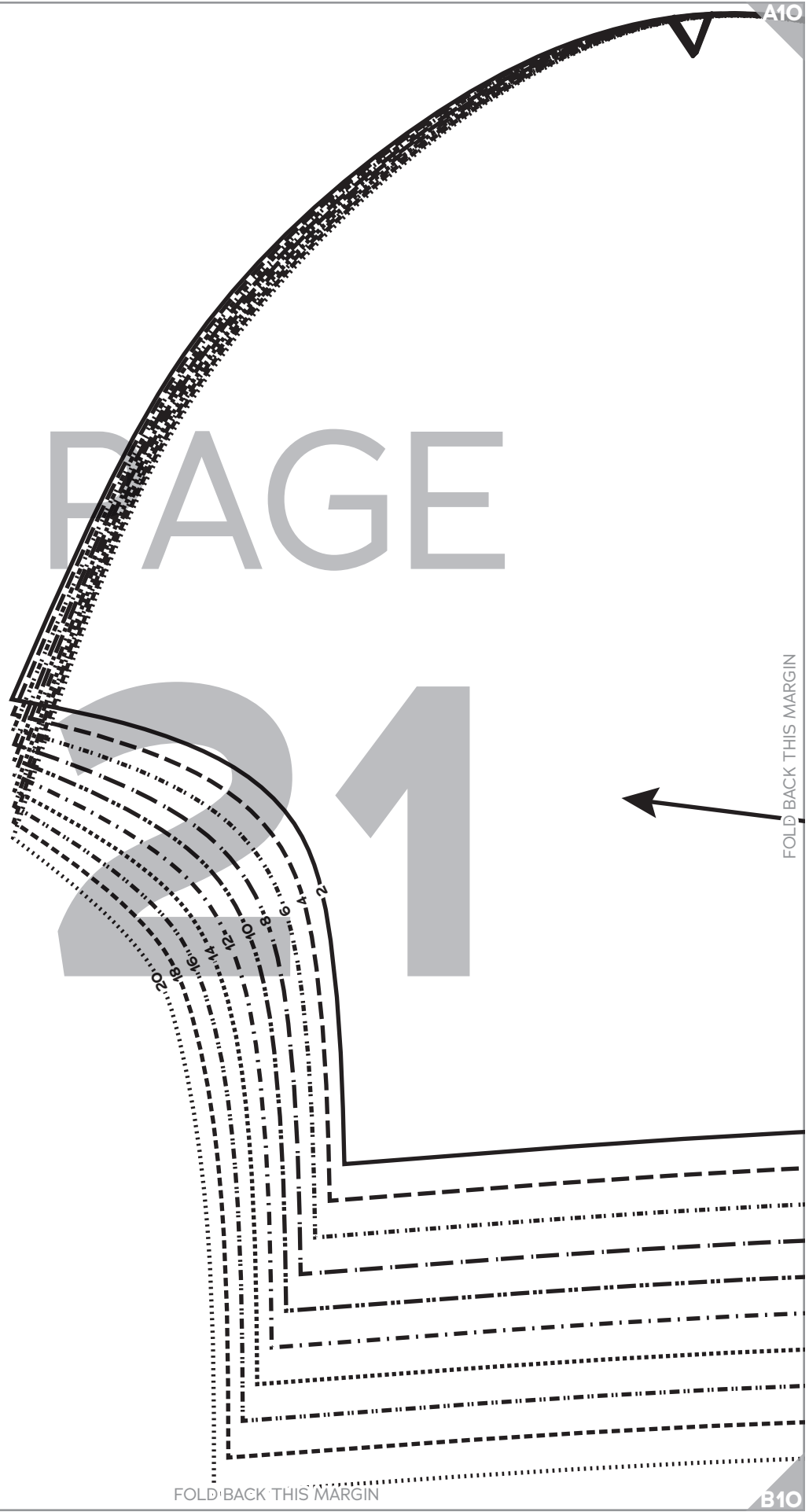

FOLD BACK THIS MARGIN

FOLD BACK THIS MARGIN

B9

B10

A10

Society
of CHARM

Barbara

BODICE
SIZES 2-20

3

Bodice Side Front,
H Cup

Cut 2 fabric, 2 lining

PAGE
22

GRAINLINE

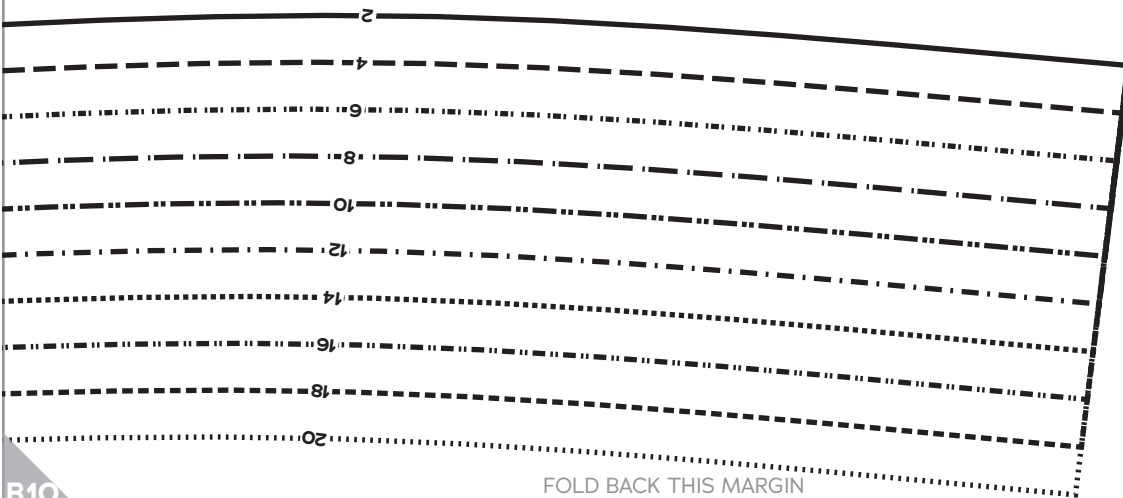

B10

FOLD BACK THIS MARGIN

GRAINLINE

Society
of CHARM
Barbara

BODICE
SIZES 2-20

5

Bodice Center Back,
Wide Strap
Cut 2 fabric, 2 lining

PAGE 5

23

FOLD BACK THIS MARGIN

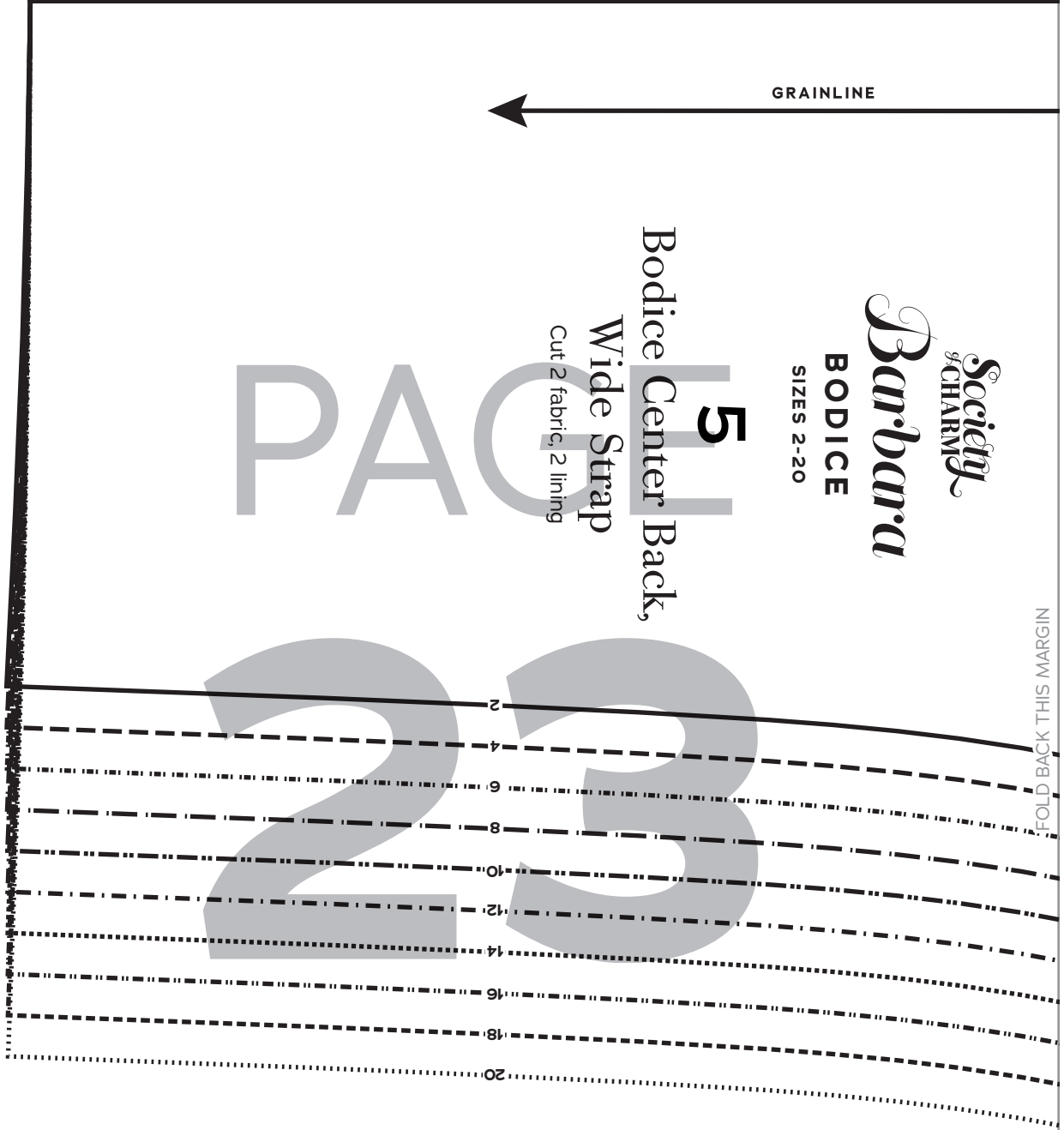

1 in
test
square

2 cm
test
square

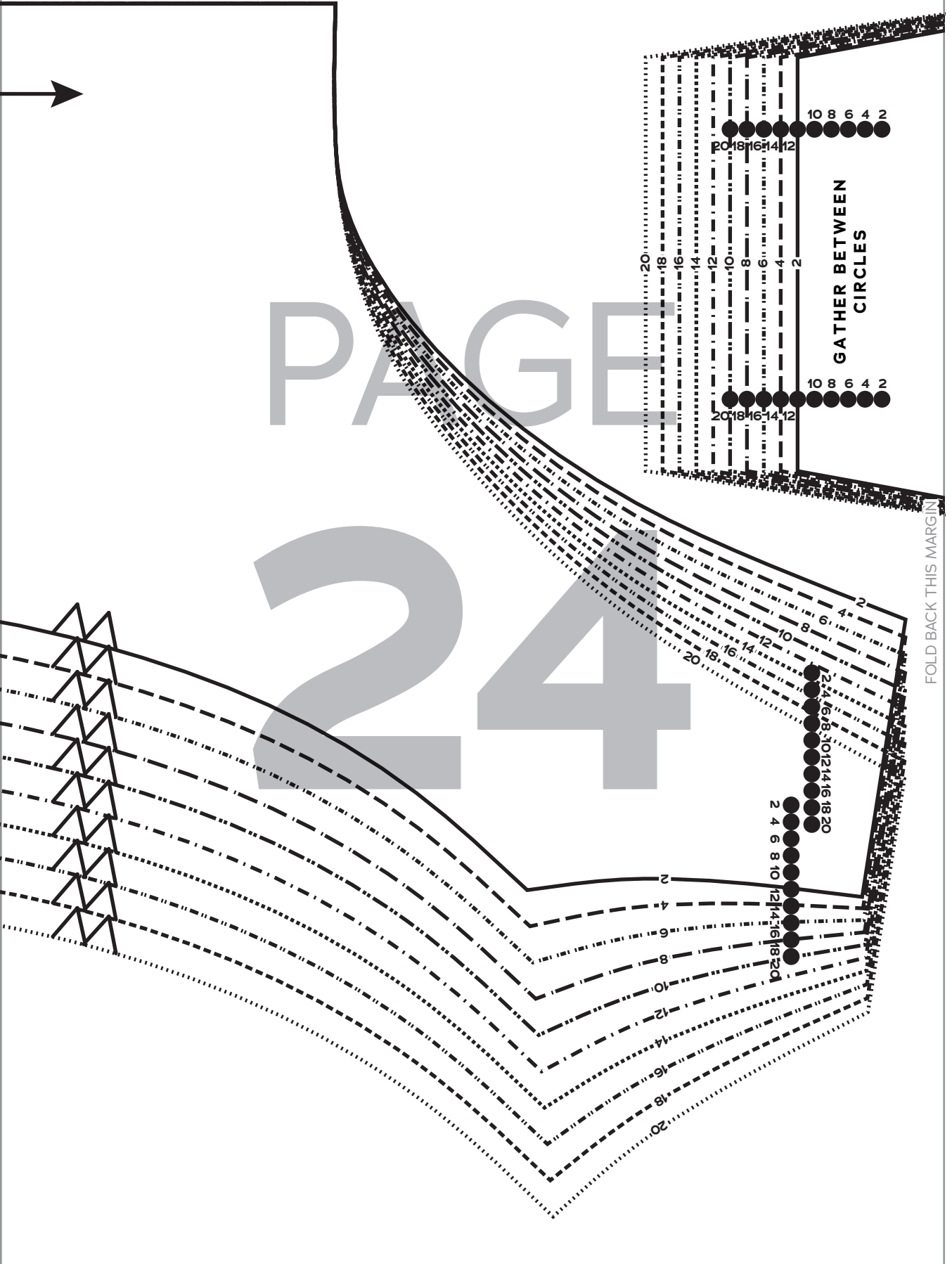

PAGE

24

GATHER BETWEEN CIRCLES

FOLD BACK THIS MARGIN

Society
 of CHARM
Barbara
BODICE
 SIZES 2-20

8
 Wide
 Gathered
 Strap
 Cut 4 fabric,
 2 interfacing



25

FOLD BACK THIS MARGIN

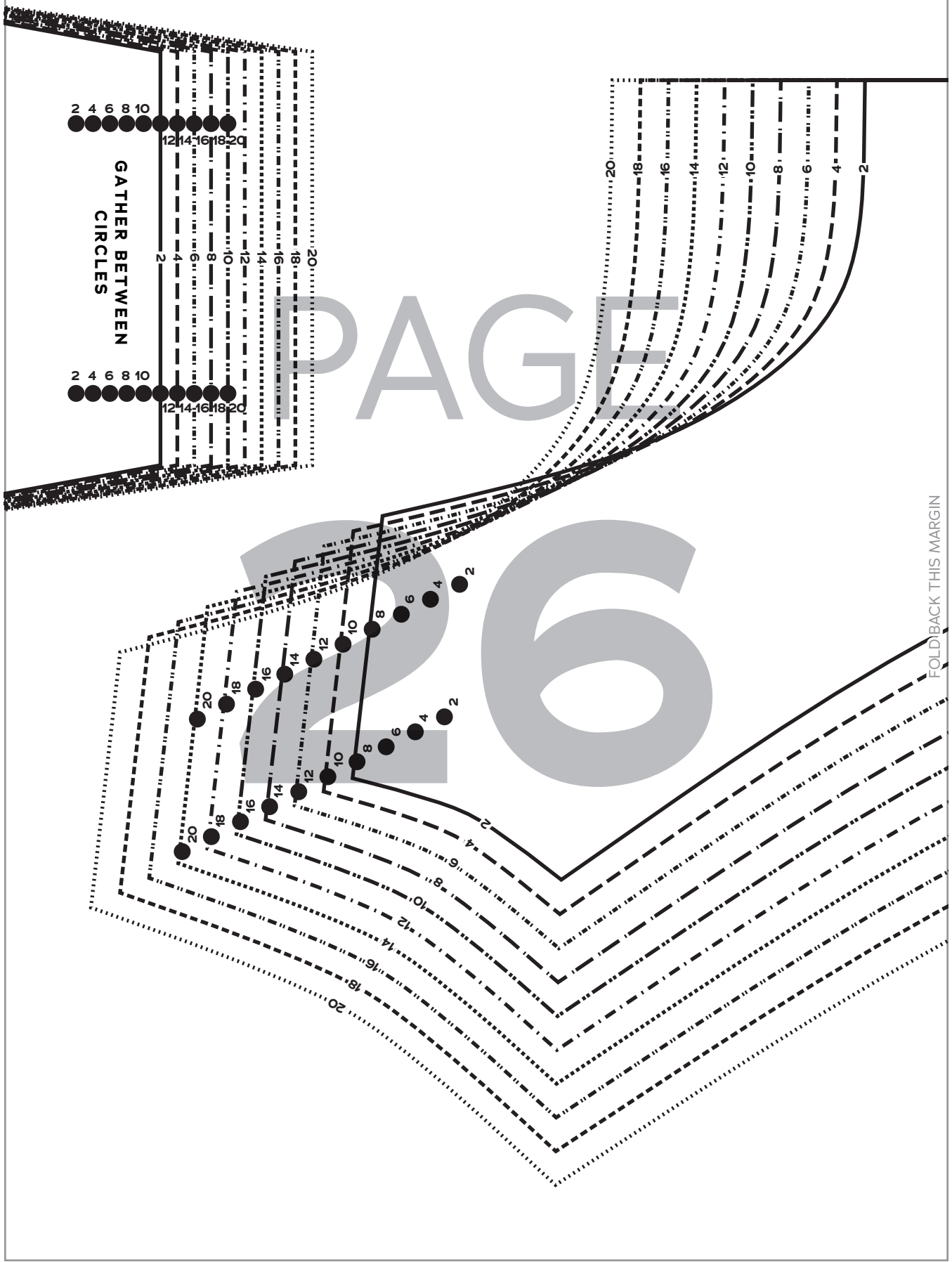

Society
of CHARM
Barbara

BODICE
SIZES 2-20

2

Bodice Center Front,
Wide Strap,
A Cup

Cut 1 fabric on fold, 1 lining on fold

FOLD

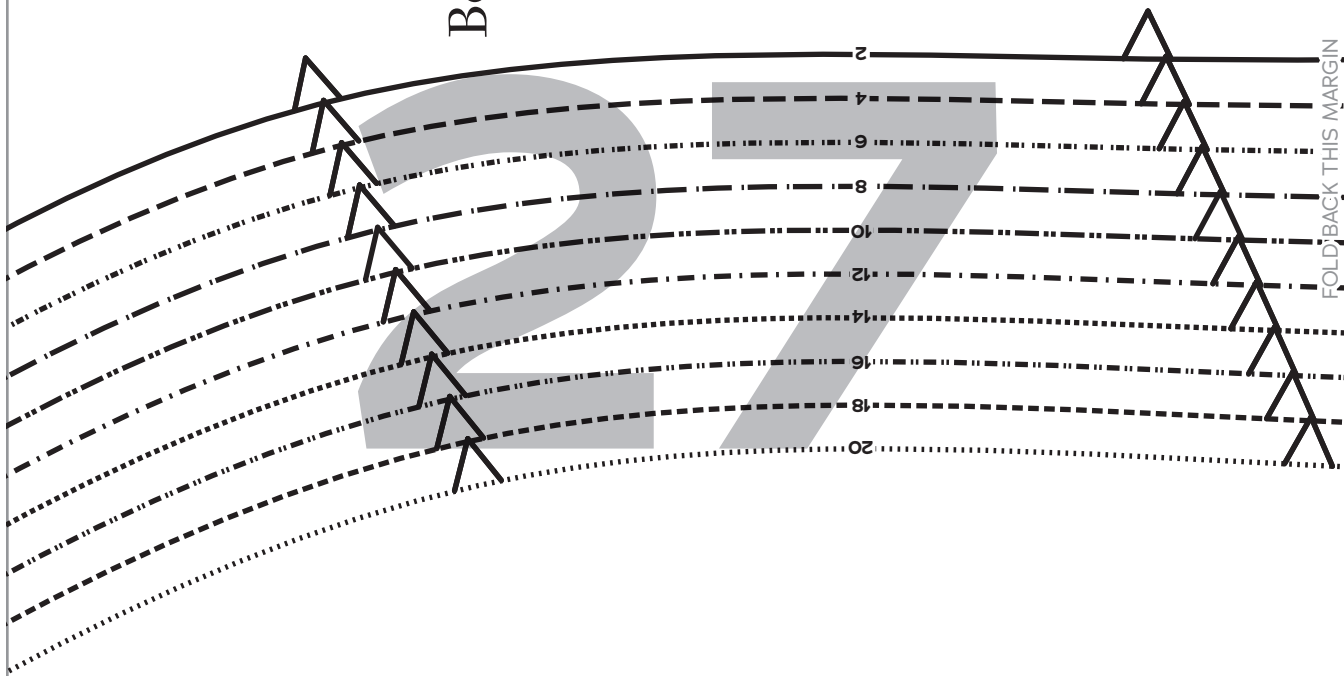

FOLD BACK THIS MARGIN

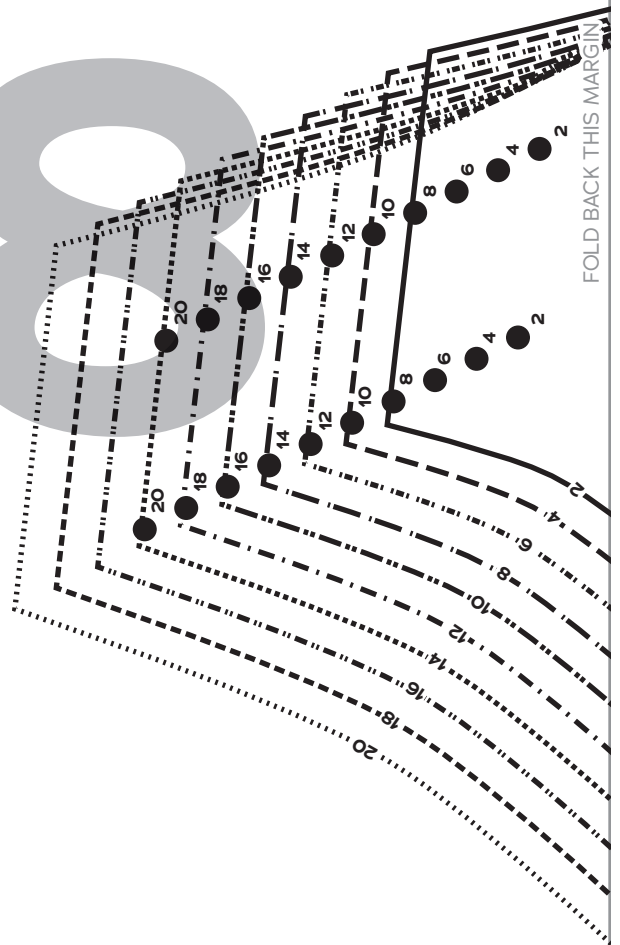
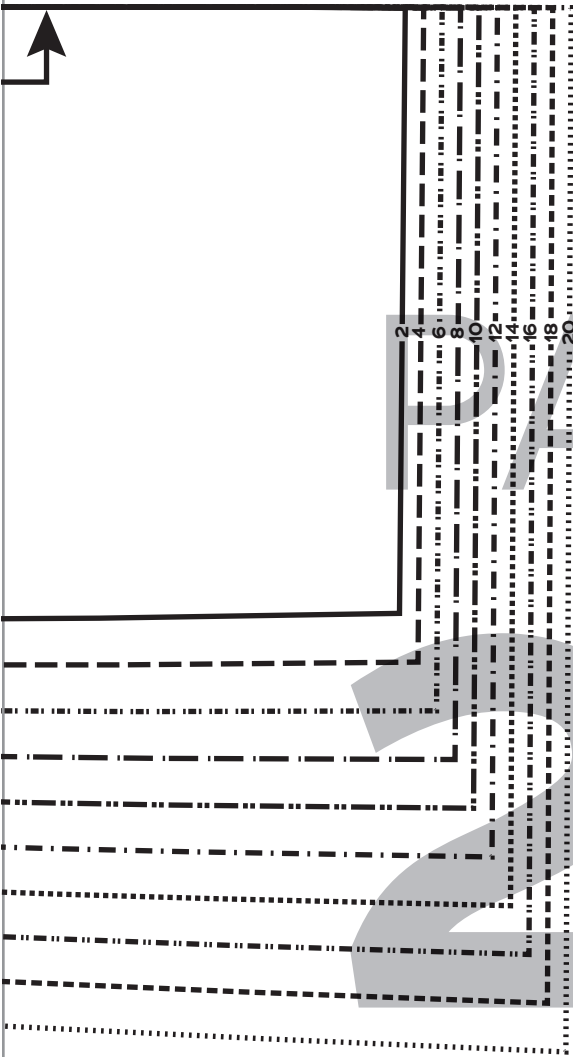

FOLD BACK THIS MARGIN

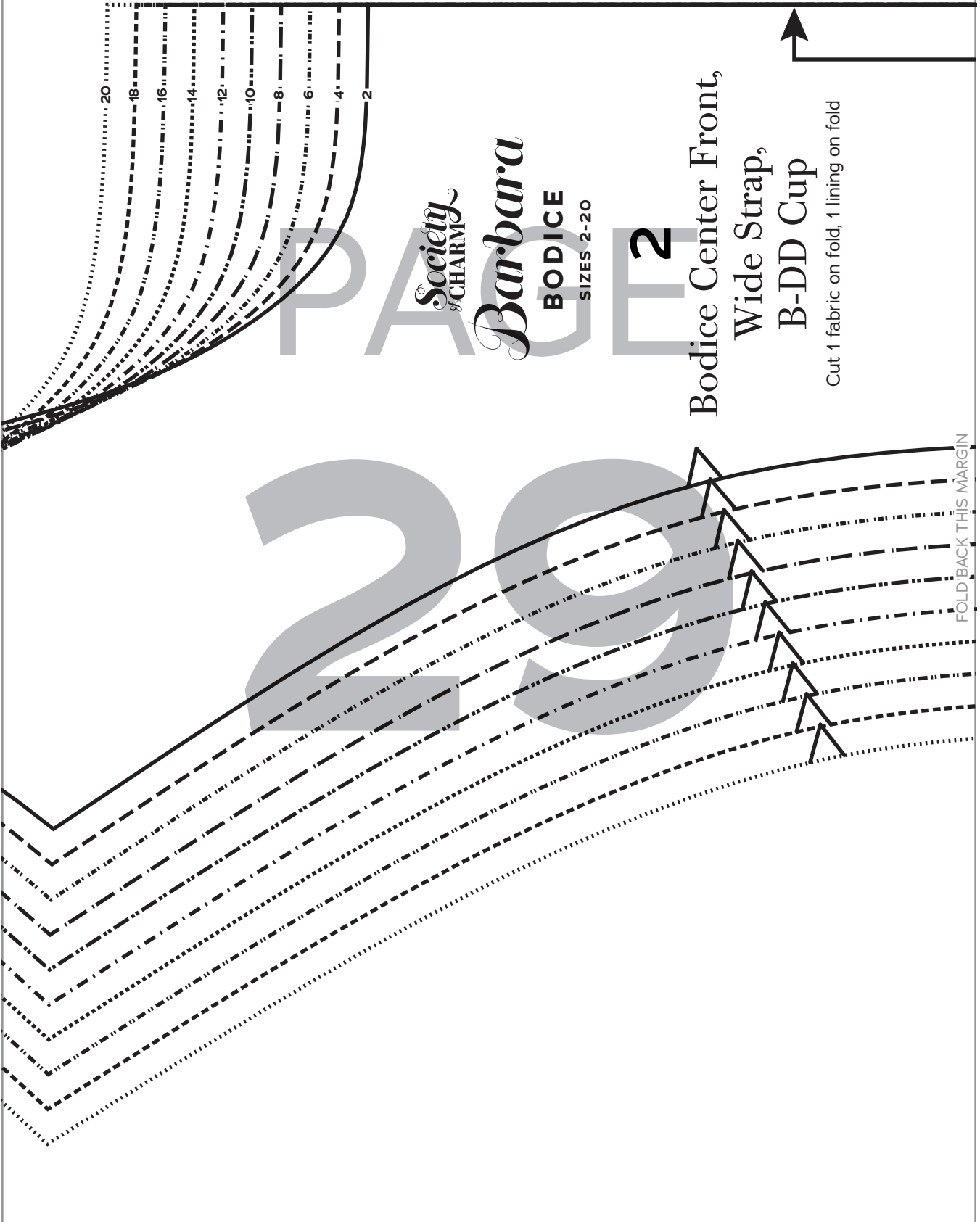

Society of CHARM

Barbara

BODICE
SIZES 2-20

2

Bodice Center Front,
Wide Strap,
B-DD Cup

Cut 1 fabric on fold, 1 lining on fold

FOLD BACK THIS MARGIN

FOLD



PAGE

2
4
6
8
10
12
14
16
18
20

FOLD BACK THIS MARGIN

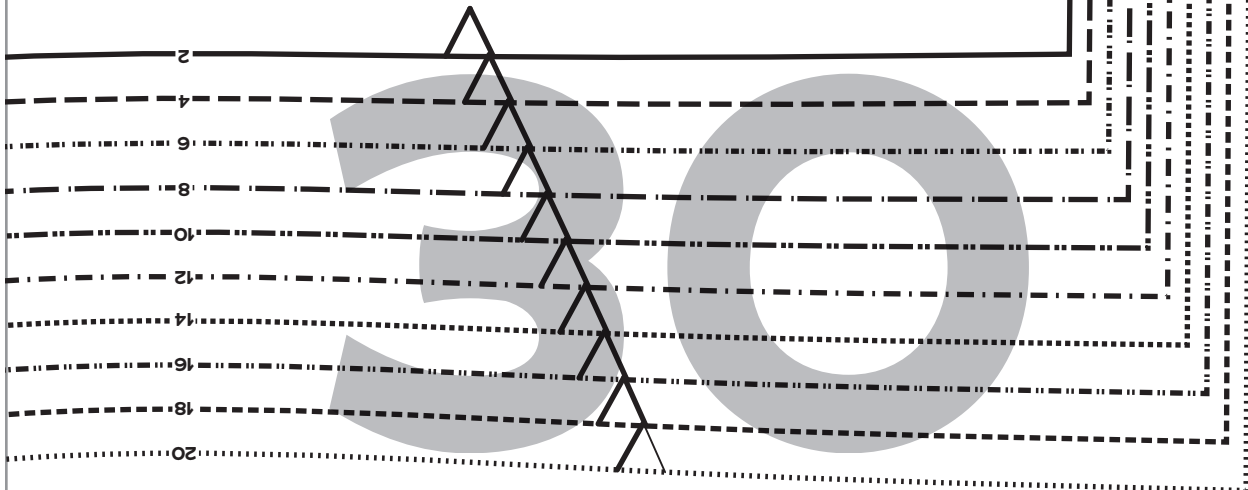

PAGE

31

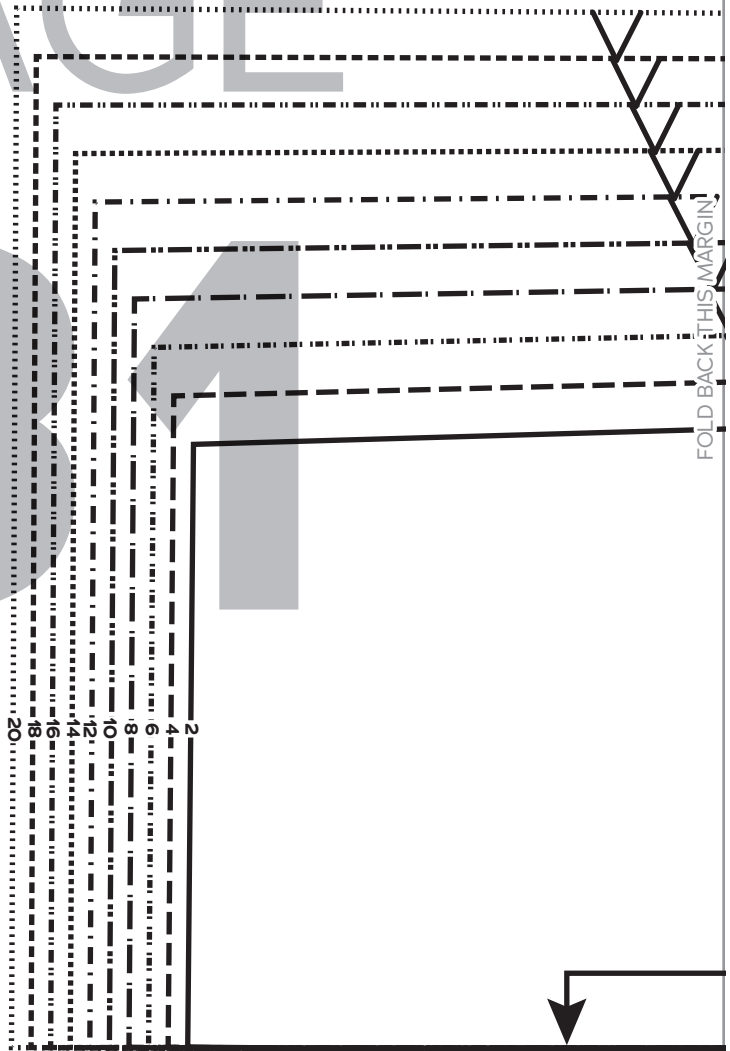

PAGE 32

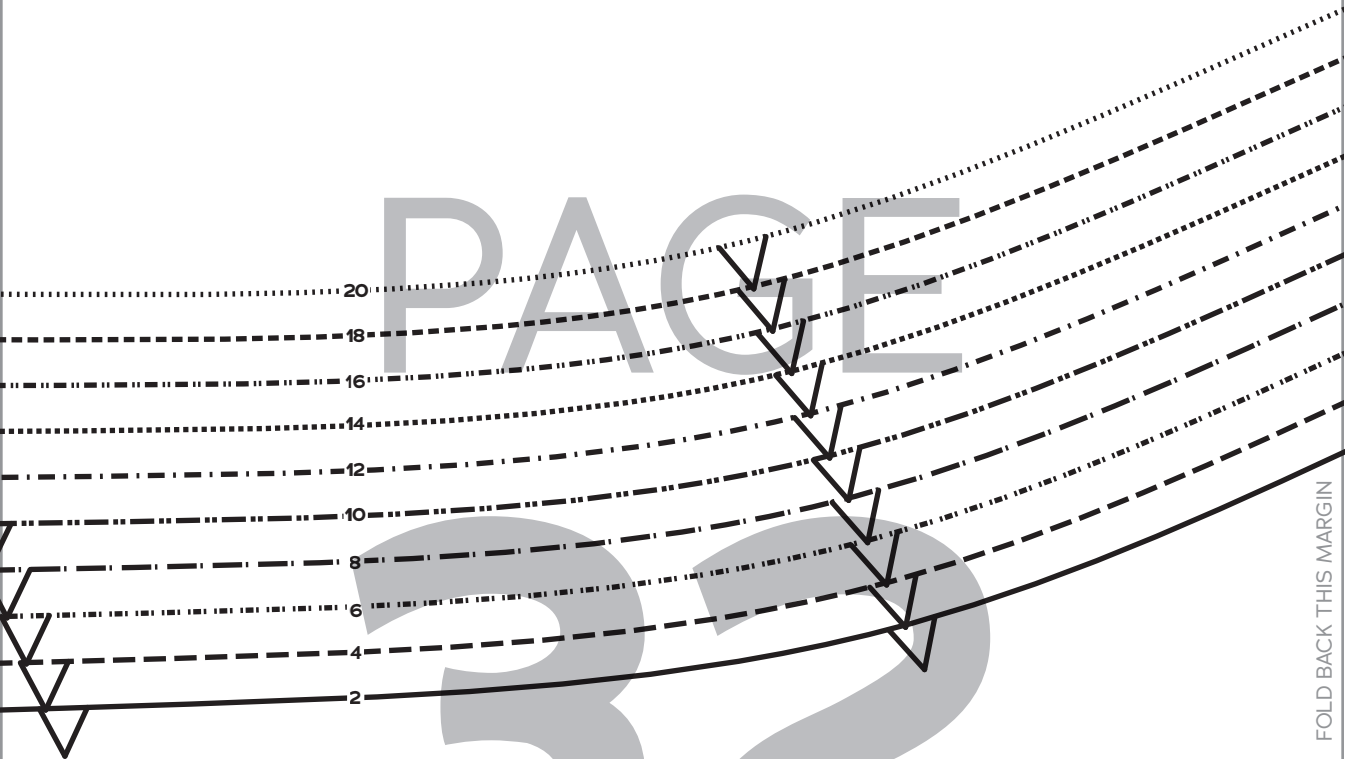

FOLD BACK THIS MARGIN

Society of CHARM
Barbara
BODICE
 SIZES 2-20

2

Bodice Center Front,
 Wide Strap,
 F-H Cup
 Cut 1 fabric on fold, 1 lining on fold

FOLD

